







Assembly code	Assembly revision	Assembly image
ASM2911A/0.D00	Cooking chamber	
ASM2916A/0.D00	External cover	
ASM2926A/0.D01	Electrical system	
ASM2921A/0.D01	Door	

ASM2911A/0.D00 - Cooking chamber

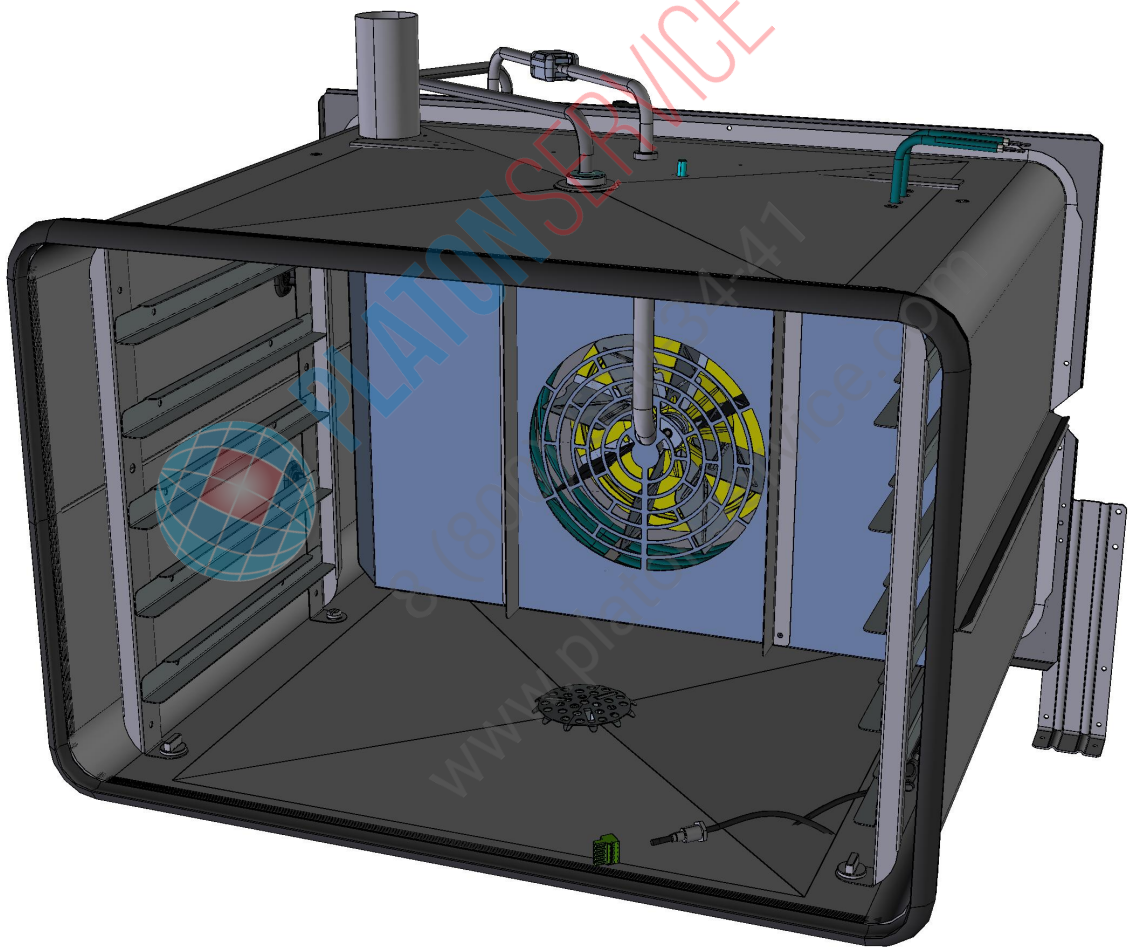

FRONT



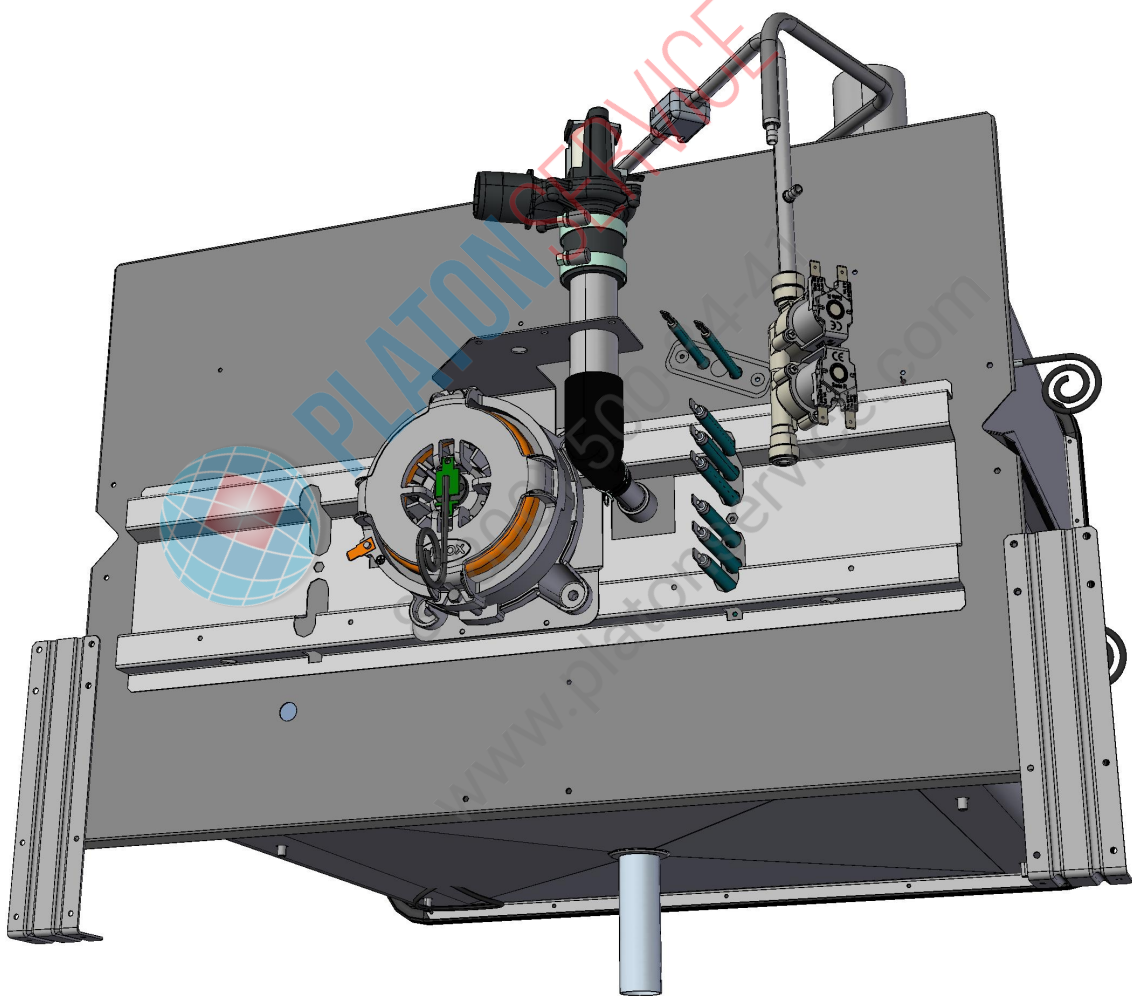

ASM2911A/0.D00 - Cooking chamber

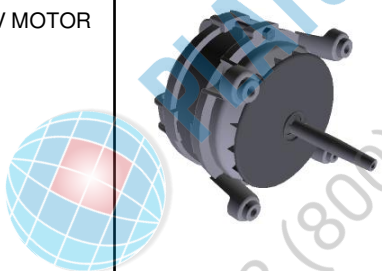

REAR



COMPONENT			SPARE PART																																																		
Code	Description	Image	Code	Description	Components list																																																
TB2951A	XEVC-0511-E INTERNAL WATER PIPE		TB2951A0	XEVC-0511-E INTERNAL WATER PIPE																																																	
0G1549B	XEVC-0511-E FAN GUARD WITH FLAPS		0G1549B0	XEVC-0511-E FAN GUARD WITH FLAPS																																																	
MT1012A	330W 230V MOTOR		KMT1012A	MIND.MAPS 330W 230V MOTOR KIT	<table border="1"> <thead> <tr> <th>Code</th> <th>Description</th> <th>Qty</th> <th>UOM</th> </tr> </thead> <tbody> <tr> <td>0H4305A1</td> <td>ST. STEEL MOTOR SHAFT SEALING DISC</td> <td>1</td> <td>PZ</td> </tr> <tr> <td>GN1140A2</td> <td>MOTOR HOLDER GASKET</td> <td>1</td> <td>PZ</td> </tr> <tr> <td>GN1140A3</td> <td></td> <td>1</td> <td>PZ</td> </tr> <tr> <td>MT1012A0</td> <td>330W 230V MOTOR</td> <td>1</td> <td>PZ</td> </tr> <tr> <td>VE1550A0</td> <td>5X3 MM NEODYMIUM MAGNET</td> <td>1</td> <td>PZ</td> </tr> <tr> <td>VI1077A1</td> <td>SCREW M6X12 TE INOX</td> <td>1</td> <td>PZ</td> </tr> <tr> <td>VI1521A0</td> <td>STAINLESS STEEL WASHER D=6 6592</td> <td>1</td> <td>PZ</td> </tr> <tr> <td>VI1966A0</td> <td>M4X14 FLATHEAD SCREW</td> <td>1</td> <td>PZ</td> </tr> <tr> <td>VM1635A0</td> <td>MAGNET HOLDING DIS</td> <td>1</td> <td>PZ</td> </tr> <tr> <td>VM1794A0</td> <td>250X4.8 PA66 BLACK CLAMP</td> <td>4</td> <td>PZ</td> </tr> <tr> <td>VM2103A0</td> <td>CLAMP LOCK</td> <td>4</td> <td>PZ</td> </tr> </tbody> </table>	Code	Description	Qty	UOM	0H4305A1	ST. STEEL MOTOR SHAFT SEALING DISC	1	PZ	GN1140A2	MOTOR HOLDER GASKET	1	PZ	GN1140A3		1	PZ	MT1012A0	330W 230V MOTOR	1	PZ	VE1550A0	5X3 MM NEODYMIUM MAGNET	1	PZ	VI1077A1	SCREW M6X12 TE INOX	1	PZ	VI1521A0	STAINLESS STEEL WASHER D=6 6592	1	PZ	VI1966A0	M4X14 FLATHEAD SCREW	1	PZ	VM1635A0	MAGNET HOLDING DIS	1	PZ	VM1794A0	250X4.8 PA66 BLACK CLAMP	4	PZ	VM2103A0	CLAMP LOCK	4	PZ
Code	Description	Qty	UOM																																																		
0H4305A1	ST. STEEL MOTOR SHAFT SEALING DISC	1	PZ																																																		
GN1140A2	MOTOR HOLDER GASKET	1	PZ																																																		
GN1140A3		1	PZ																																																		
MT1012A0	330W 230V MOTOR	1	PZ																																																		
VE1550A0	5X3 MM NEODYMIUM MAGNET	1	PZ																																																		
VI1077A1	SCREW M6X12 TE INOX	1	PZ																																																		
VI1521A0	STAINLESS STEEL WASHER D=6 6592	1	PZ																																																		
VI1966A0	M4X14 FLATHEAD SCREW	1	PZ																																																		
VM1635A0	MAGNET HOLDING DIS	1	PZ																																																		
VM1794A0	250X4.8 PA66 BLACK CLAMP	4	PZ																																																		
VM2103A0	CLAMP LOCK	4	PZ																																																		

COMPONENT			SPARE PART																										
Code	Description	Image	Code	Description	Components list																								
0H7170A	MM MOTOR GLASS WOOL PLATE		0H7170A0	MM MOTOR GLASS WOOL PLATE																									
GN1140A	MOTOR HOLDER GASKET		KGN1140A	5 PCS. MOTOR HOLDER GASKET KI	<table border="1"> <thead> <tr> <th>Code</th> <th>Description</th> <th>Qty</th> <th>UOM</th> </tr> </thead> <tbody> <tr> <td>GN1140A2</td> <td>MOTOR HOLDER GASKET</td> <td>5</td> <td>PZ</td> </tr> <tr> <td>GN1140A3</td> <td></td> <td>5</td> <td>PZ</td> </tr> </tbody> </table>	Code	Description	Qty	UOM	GN1140A2	MOTOR HOLDER GASKET	5	PZ	GN1140A3		5	PZ												
Code	Description	Qty	UOM																										
GN1140A2	MOTOR HOLDER GASKET	5	PZ																										
GN1140A3		5	PZ																										
0H4305A	ST. STEEL MOTOR SHAFT SEALING DIS		K0H4305A	SEALING DISC FOR MOTOR SHAFT KIT	<table border="1"> <thead> <tr> <th>Code</th> <th>Description</th> <th>Qty</th> <th>UOM</th> </tr> </thead> <tbody> <tr> <td>0H4305A1</td> <td>ST. STEEL MOTOR SHAFT SEALING DISC</td> <td>1</td> <td>PZ</td> </tr> <tr> <td>GN1140A2</td> <td>MOTOR HOLDER GASKET</td> <td>1</td> <td>PZ</td> </tr> <tr> <td>GN1140A3</td> <td></td> <td>1</td> <td>PZ</td> </tr> <tr> <td>SL1045A0</td> <td>S57 BLACK SILICONE - 80ML CARTRIDGE</td> <td>1</td> <td>PZ</td> </tr> <tr> <td>VI1220A1</td> <td>4,2X12 TCB SELF-TAPPIN G SCREW</td> <td>3</td> <td>PZ</td> </tr> </tbody> </table>	Code	Description	Qty	UOM	0H4305A1	ST. STEEL MOTOR SHAFT SEALING DISC	1	PZ	GN1140A2	MOTOR HOLDER GASKET	1	PZ	GN1140A3		1	PZ	SL1045A0	S57 BLACK SILICONE - 80ML CARTRIDGE	1	PZ	VI1220A1	4,2X12 TCB SELF-TAPPIN G SCREW	3	PZ
Code	Description	Qty	UOM																										
0H4305A1	ST. STEEL MOTOR SHAFT SEALING DISC	1	PZ																										
GN1140A2	MOTOR HOLDER GASKET	1	PZ																										
GN1140A3		1	PZ																										
SL1045A0	S57 BLACK SILICONE - 80ML CARTRIDGE	1	PZ																										
VI1220A1	4,2X12 TCB SELF-TAPPIN G SCREW	3	PZ																										
VN1170A	D195 H80 8 BLADES FAN		KVN1170B	D195 H80 8 BLADES FAN + RING KIT	<table border="1"> <thead> <tr> <th>Code</th> <th>Description</th> <th>Qty</th> <th>UOM</th> </tr> </thead> <tbody> <tr> <td>VI1077A1</td> <td>SCREW M6X12 TE INOX</td> <td>1</td> <td>PZ</td> </tr> <tr> <td>VI1521A0</td> <td>STAINLESS STEEL WASHER D=6 6592</td> <td>1</td> <td>PZ</td> </tr> <tr> <td>VN1170B0</td> <td>D195 H80 8 BLADES FAN+RING</td> <td>1</td> <td>PZ</td> </tr> <tr> <td>VN1170B0</td> <td>D195 H80 8 BLADES FAN+RING</td> <td>1</td> <td>PZ</td> </tr> </tbody> </table>	Code	Description	Qty	UOM	VI1077A1	SCREW M6X12 TE INOX	1	PZ	VI1521A0	STAINLESS STEEL WASHER D=6 6592	1	PZ	VN1170B0	D195 H80 8 BLADES FAN+RING	1	PZ	VN1170B0	D195 H80 8 BLADES FAN+RING	1	PZ				
Code	Description	Qty	UOM																										
VI1077A1	SCREW M6X12 TE INOX	1	PZ																										
VI1521A0	STAINLESS STEEL WASHER D=6 6592	1	PZ																										
VN1170B0	D195 H80 8 BLADES FAN+RING	1	PZ																										
VN1170B0	D195 H80 8 BLADES FAN+RING	1	PZ																										

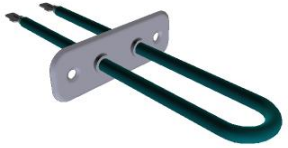
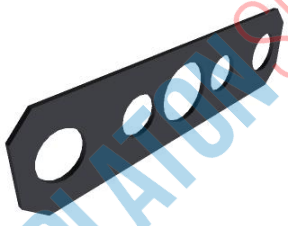

COMPONENT			SPARE PART																																										
Code	Description	Image	Code	Description	Components list																																								
PE1710B	MOTOR REVOLUTION AND DIRECTION SENSO		KPE1710B	MOTOR REVOLUTIONS SENSOR KIT	<table border="1"> <thead> <tr> <th>Code</th> <th>Description</th> <th>Qty</th> <th>UOM</th> </tr> </thead> <tbody> <tr> <td>PE1710B0</td> <td>MOTOR REVOLUTION AND DIRECTION SENSOR</td> <td>1</td> <td>PZ</td> </tr> <tr> <td>VE1550A0</td> <td>5X3 MM NEODYMIUM MAGNET</td> <td>1</td> <td>PZ</td> </tr> <tr> <td>VI1966A0</td> <td>M4X14 FLATHEAD SCREW</td> <td>1</td> <td>PZ</td> </tr> <tr> <td>VM1635A0</td> <td>MAGNET HOLDING DIS</td> <td>1</td> <td>PZ</td> </tr> </tbody> </table>	Code	Description	Qty	UOM	PE1710B0	MOTOR REVOLUTION AND DIRECTION SENSOR	1	PZ	VE1550A0	5X3 MM NEODYMIUM MAGNET	1	PZ	VI1966A0	M4X14 FLATHEAD SCREW	1	PZ	VM1635A0	MAGNET HOLDING DIS	1	PZ																				
Code	Description	Qty	UOM																																										
PE1710B0	MOTOR REVOLUTION AND DIRECTION SENSOR	1	PZ																																										
VE1550A0	5X3 MM NEODYMIUM MAGNET	1	PZ																																										
VI1966A0	M4X14 FLATHEAD SCREW	1	PZ																																										
VM1635A0	MAGNET HOLDING DIS	1	PZ																																										
VE1550A	5X3 MM NEODYMIUM MAGNET		KPE1710B	MOTOR REVOLUTIONS SENSOR KIT	<table border="1"> <thead> <tr> <th>Code</th> <th>Description</th> <th>Qty</th> <th>UOM</th> </tr> </thead> <tbody> <tr> <td>PE1710B0</td> <td>MOTOR REVOLUTION AND DIRECTION SENSOR</td> <td>1</td> <td>PZ</td> </tr> <tr> <td>VE1550A0</td> <td>5X3 MM NEODYMIUM MAGNET</td> <td>1</td> <td>PZ</td> </tr> <tr> <td>VI1966A0</td> <td>M4X14 FLATHEAD SCREW</td> <td>1</td> <td>PZ</td> </tr> <tr> <td>VM1635A0</td> <td>MAGNET HOLDING DIS</td> <td>1</td> <td>PZ</td> </tr> </tbody> </table>	Code	Description	Qty	UOM	PE1710B0	MOTOR REVOLUTION AND DIRECTION SENSOR	1	PZ	VE1550A0	5X3 MM NEODYMIUM MAGNET	1	PZ	VI1966A0	M4X14 FLATHEAD SCREW	1	PZ	VM1635A0	MAGNET HOLDING DIS	1	PZ																				
Code	Description	Qty	UOM																																										
PE1710B0	MOTOR REVOLUTION AND DIRECTION SENSOR	1	PZ																																										
VE1550A0	5X3 MM NEODYMIUM MAGNET	1	PZ																																										
VI1966A0	M4X14 FLATHEAD SCREW	1	PZ																																										
VM1635A0	MAGNET HOLDING DIS	1	PZ																																										
RS1180A	9 KW 230V 6 TURNS CIRC. HEATING ELEMENT		KRS1180A	9KW 6 TURNS CIRC. HEATING ELEMENT KIT	<table border="1"> <thead> <tr> <th>Code</th> <th>Description</th> <th>Qty</th> <th>UOM</th> </tr> </thead> <tbody> <tr> <td>GN1086A0</td> <td>ELEMENT SEALING</td> <td>1</td> <td>PZ</td> </tr> <tr> <td>RS1180A1</td> <td>9 KW 230V 6 TURNS CIRC. HEATING ELEMENT</td> <td>1</td> <td>PZ</td> </tr> <tr> <td>SL1045A0</td> <td>S57 BLACK SILICONE - 80ML CARTRIDGE</td> <td>1</td> <td>PZ</td> </tr> <tr> <td>VI1032A0</td> <td>SCREW M4X16 TCB+ INOX</td> <td>1</td> <td>PZ</td> </tr> <tr> <td>VI1075A0</td> <td>NUT M4 H=4 UNI5587 INOX</td> <td>1</td> <td>PZ</td> </tr> <tr> <td>VI1220A1</td> <td>4,2X12 TCB SELF-TAPPIN G SCREW</td> <td>6</td> <td>PZ</td> </tr> <tr> <td>VI1511A0</td> <td>STAINLESS STEEL WASHER 4.2X12X1</td> <td>1</td> <td>PZ</td> </tr> <tr> <td>VM1794A0</td> <td>250X4.8 PA66 BLACK CLAMP</td> <td>2</td> <td>PZ</td> </tr> <tr> <td>VM2103A0</td> <td>CLAMP LOCK</td> <td>2</td> <td>PZ</td> </tr> </tbody> </table>	Code	Description	Qty	UOM	GN1086A0	ELEMENT SEALING	1	PZ	RS1180A1	9 KW 230V 6 TURNS CIRC. HEATING ELEMENT	1	PZ	SL1045A0	S57 BLACK SILICONE - 80ML CARTRIDGE	1	PZ	VI1032A0	SCREW M4X16 TCB+ INOX	1	PZ	VI1075A0	NUT M4 H=4 UNI5587 INOX	1	PZ	VI1220A1	4,2X12 TCB SELF-TAPPIN G SCREW	6	PZ	VI1511A0	STAINLESS STEEL WASHER 4.2X12X1	1	PZ	VM1794A0	250X4.8 PA66 BLACK CLAMP	2	PZ	VM2103A0	CLAMP LOCK	2	PZ
Code	Description	Qty	UOM																																										
GN1086A0	ELEMENT SEALING	1	PZ																																										
RS1180A1	9 KW 230V 6 TURNS CIRC. HEATING ELEMENT	1	PZ																																										
SL1045A0	S57 BLACK SILICONE - 80ML CARTRIDGE	1	PZ																																										
VI1032A0	SCREW M4X16 TCB+ INOX	1	PZ																																										
VI1075A0	NUT M4 H=4 UNI5587 INOX	1	PZ																																										
VI1220A1	4,2X12 TCB SELF-TAPPIN G SCREW	6	PZ																																										
VI1511A0	STAINLESS STEEL WASHER 4.2X12X1	1	PZ																																										
VM1794A0	250X4.8 PA66 BLACK CLAMP	2	PZ																																										
VM2103A0	CLAMP LOCK	2	PZ																																										

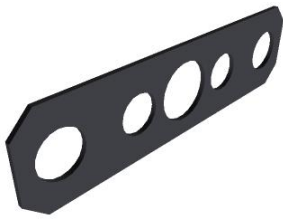
COMPONENT			SPARE PART																										
Code	Description	Image	Code	Description	Components list																								
RS1215A	147W 105V BRAKING ELEMENT		KRS1215A	147W MOTOR BRAKING ELEMENT KIT	<table border="1"> <thead> <tr> <th>Code</th> <th>Description</th> <th>Qty</th> <th>UOM</th> </tr> </thead> <tbody> <tr> <td>GN1326A1</td> <td>ELEMENT SEALING</td> <td>1</td> <td>PZ</td> </tr> <tr> <td>RS1215A1</td> <td>147W 105V BRAKING ELEMENT</td> <td>1</td> <td>PZ</td> </tr> <tr> <td>SL1045A0</td> <td>S57 BLACK SILICONE - 80ML CARTRIDGE</td> <td>1</td> <td>PZ</td> </tr> <tr> <td>VI1220A1</td> <td>4,2X12 TCB SELF-TAPPIN G SCREW</td> <td>2</td> <td>PZ</td> </tr> </tbody> </table>	Code	Description	Qty	UOM	GN1326A1	ELEMENT SEALING	1	PZ	RS1215A1	147W 105V BRAKING ELEMENT	1	PZ	SL1045A0	S57 BLACK SILICONE - 80ML CARTRIDGE	1	PZ	VI1220A1	4,2X12 TCB SELF-TAPPIN G SCREW	2	PZ				
					Code	Description	Qty	UOM																					
GN1326A1	ELEMENT SEALING	1	PZ																										
RS1215A1	147W 105V BRAKING ELEMENT	1	PZ																										
SL1045A0	S57 BLACK SILICONE - 80ML CARTRIDGE	1	PZ																										
VI1220A1	4,2X12 TCB SELF-TAPPIN G SCREW	2	PZ																										
GN1326A	ELEMENT SEALING		KRS1274A	100W MOTOR BRAKING ELEMENT KIT	<table border="1"> <thead> <tr> <th>Code</th> <th>Description</th> <th>Qty</th> <th>UOM</th> </tr> </thead> <tbody> <tr> <td>GN1326A1</td> <td>ELEMENT SEALING</td> <td>1</td> <td>PZ</td> </tr> <tr> <td>RS1274A0</td> <td>100W 60V 1 TURN FLAT ELEMENT</td> <td>1</td> <td>PZ</td> </tr> <tr> <td>SL1045A0</td> <td>S57 BLACK SILICONE - 80ML CARTRIDGE</td> <td>1</td> <td>PZ</td> </tr> <tr> <td>VI1220A1</td> <td>4,2X12 TCB SELF-TAPPIN G SCREW</td> <td>2</td> <td>PZ</td> </tr> </tbody> </table>	Code	Description	Qty	UOM	GN1326A1	ELEMENT SEALING	1	PZ	RS1274A0	100W 60V 1 TURN FLAT ELEMENT	1	PZ	SL1045A0	S57 BLACK SILICONE - 80ML CARTRIDGE	1	PZ	VI1220A1	4,2X12 TCB SELF-TAPPIN G SCREW	2	PZ				
Code	Description	Qty	UOM																										
GN1326A1	ELEMENT SEALING	1	PZ																										
RS1274A0	100W 60V 1 TURN FLAT ELEMENT	1	PZ																										
SL1045A0	S57 BLACK SILICONE - 80ML CARTRIDGE	1	PZ																										
VI1220A1	4,2X12 TCB SELF-TAPPIN G SCREW	2	PZ																										
			KRS1261A	122W MOTOR BREAKING ELEMENT KIT	<table border="1"> <thead> <tr> <th>Code</th> <th>Description</th> <th>Qty</th> <th>UOM</th> </tr> </thead> <tbody> <tr> <td>GN1326A1</td> <td>ELEMENT SEALING</td> <td>1</td> <td>PZ</td> </tr> <tr> <td>RS1261A0</td> <td>BAKERLUX\CH EFLUX MOTOR BREAKING ELEMENT</td> <td>1</td> <td>PZ</td> </tr> <tr> <td>SL1045A0</td> <td>S57 BLACK SILICONE - 80ML CARTRIDGE</td> <td>1</td> <td>PZ</td> </tr> <tr> <td>VI1220A1</td> <td>4,2X12 TCB SELF-TAPPIN G SCREW</td> <td>2</td> <td>PZ</td> </tr> <tr> <td>VM2147A0</td> <td>ESD SPONGE PINK SMOOTH 410X343X15 M</td> <td>1</td> <td>PZ</td> </tr> </tbody> </table>	Code	Description	Qty	UOM	GN1326A1	ELEMENT SEALING	1	PZ	RS1261A0	BAKERLUX\CH EFLUX MOTOR BREAKING ELEMENT	1	PZ	SL1045A0	S57 BLACK SILICONE - 80ML CARTRIDGE	1	PZ	VI1220A1	4,2X12 TCB SELF-TAPPIN G SCREW	2	PZ	VM2147A0	ESD SPONGE PINK SMOOTH 410X343X15 M	1	PZ
Code	Description	Qty	UOM																										
GN1326A1	ELEMENT SEALING	1	PZ																										
RS1261A0	BAKERLUX\CH EFLUX MOTOR BREAKING ELEMENT	1	PZ																										
SL1045A0	S57 BLACK SILICONE - 80ML CARTRIDGE	1	PZ																										
VI1220A1	4,2X12 TCB SELF-TAPPIN G SCREW	2	PZ																										
VM2147A0	ESD SPONGE PINK SMOOTH 410X343X15 M	1	PZ																										
			KRS1215A	147W MOTOR BRAKING ELEMENT KIT	<table border="1"> <thead> <tr> <th>Code</th> <th>Description</th> <th>Qty</th> <th>UOM</th> </tr> </thead> <tbody> <tr> <td>GN1326A1</td> <td>ELEMENT SEALING</td> <td>1</td> <td>PZ</td> </tr> <tr> <td>RS1215A1</td> <td>147W 105V BRAKING ELEMENT</td> <td>1</td> <td>PZ</td> </tr> </tbody> </table>	Code	Description	Qty	UOM	GN1326A1	ELEMENT SEALING	1	PZ	RS1215A1	147W 105V BRAKING ELEMENT	1	PZ												
Code	Description	Qty	UOM																										
GN1326A1	ELEMENT SEALING	1	PZ																										
RS1215A1	147W 105V BRAKING ELEMENT	1	PZ																										

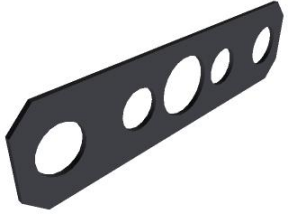

COMPONENT			SPARE PART																											
Code	Description	Image	Code	Description	Components list																									
GN1326A	ELEMENT SEALING		KRS1215A	147W MOTOR BRAKING ELEMENT KIT	<table border="1"> <thead> <tr> <th>Code</th> <th>Description</th> <th>Qty</th> <th>UOM</th> </tr> </thead> <tbody> <tr> <td>SL1045A0</td> <td>S57 BLACK SILICONE - 80ML CARTRIDGE</td> <td>1</td> <td>PZ</td> </tr> <tr> <td>VI1220A1</td> <td>4,2X12 TCB SELF-TAPPIN G SCREW</td> <td>2</td> <td>PZ</td> </tr> </tbody> </table>	Code	Description	Qty	UOM	SL1045A0	S57 BLACK SILICONE - 80ML CARTRIDGE	1	PZ	VI1220A1	4,2X12 TCB SELF-TAPPIN G SCREW	2	PZ													
			Code	Description	Qty	UOM																								
			SL1045A0	S57 BLACK SILICONE - 80ML CARTRIDGE	1	PZ																								
VI1220A1	4,2X12 TCB SELF-TAPPIN G SCREW	2	PZ																											
KRS1095A	1.2KW HEATING ELEMENT KIT	<table border="1"> <thead> <tr> <th>Code</th> <th>Description</th> <th>Qty</th> <th>UOM</th> </tr> </thead> <tbody> <tr> <td>GN1326A1</td> <td>ELEMENT SEALING</td> <td>1</td> <td>PZ</td> </tr> <tr> <td>IP1385A1</td> <td>CORNER POLYSTYREN E PACKING 110X80X2000</td> <td>0.500</td> <td>M</td> </tr> <tr> <td>RS1095A1</td> <td>HEATING ELEMENT 1200W 230V</td> <td>1</td> <td>PZ</td> </tr> <tr> <td>SL1045A0</td> <td>S57 BLACK SILICONE - 80ML CARTRIDGE</td> <td>1</td> <td>PZ</td> </tr> <tr> <td>VI1220A1</td> <td>4,2X12 TCB SELF-TAPPIN G SCREW</td> <td>2</td> <td>PZ</td> </tr> <tr> <td>VM1059A1</td> <td>HEAT SHRINK FILM H800</td> <td>1.200</td> <td>M</td> </tr> </tbody> </table>	Code	Description	Qty	UOM	GN1326A1	ELEMENT SEALING	1	PZ	IP1385A1	CORNER POLYSTYREN E PACKING 110X80X2000	0.500	M	RS1095A1	HEATING ELEMENT 1200W 230V	1	PZ	SL1045A0	S57 BLACK SILICONE - 80ML CARTRIDGE	1	PZ	VI1220A1	4,2X12 TCB SELF-TAPPIN G SCREW	2	PZ	VM1059A1	HEAT SHRINK FILM H800	1.200	M
Code	Description	Qty	UOM																											
GN1326A1	ELEMENT SEALING	1	PZ																											
IP1385A1	CORNER POLYSTYREN E PACKING 110X80X2000	0.500	M																											
RS1095A1	HEATING ELEMENT 1200W 230V	1	PZ																											
SL1045A0	S57 BLACK SILICONE - 80ML CARTRIDGE	1	PZ																											
VI1220A1	4,2X12 TCB SELF-TAPPIN G SCREW	2	PZ																											
VM1059A1	HEAT SHRINK FILM H800	1.200	M																											
KRS1012A	1365W 120V HEATING ELEMENT KIT	<table border="1"> <thead> <tr> <th>Code</th> <th>Description</th> <th>Qty</th> <th>UOM</th> </tr> </thead> <tbody> <tr> <td>GN1326A1</td> <td>ELEMENT SEALING</td> <td>1</td> <td>PZ</td> </tr> <tr> <td>RS1012A0</td> <td>CIRCULAR ELEMENT 1365W 120V</td> <td>1</td> <td>PZ</td> </tr> <tr> <td>VI1220A1</td> <td>4,2X12 TCB SELF-TAPPIN G SCREW</td> <td>5</td> <td>PZ</td> </tr> <tr> <td>VM1794A0</td> <td>250X4.8 PA66 BLACK CLAMP</td> <td>2</td> <td>PZ</td> </tr> <tr> <td>VM2103A0</td> <td>CLAMP LOCK</td> <td>2</td> <td>PZ</td> </tr> </tbody> </table>	Code	Description	Qty	UOM	GN1326A1	ELEMENT SEALING	1	PZ	RS1012A0	CIRCULAR ELEMENT 1365W 120V	1	PZ	VI1220A1	4,2X12 TCB SELF-TAPPIN G SCREW	5	PZ	VM1794A0	250X4.8 PA66 BLACK CLAMP	2	PZ	VM2103A0	CLAMP LOCK	2	PZ				
Code	Description	Qty	UOM																											
GN1326A1	ELEMENT SEALING	1	PZ																											
RS1012A0	CIRCULAR ELEMENT 1365W 120V	1	PZ																											
VI1220A1	4,2X12 TCB SELF-TAPPIN G SCREW	5	PZ																											
VM1794A0	250X4.8 PA66 BLACK CLAMP	2	PZ																											
VM2103A0	CLAMP LOCK	2	PZ																											
KRS1011A	ROBERTA/LISA HEATING ELEMENT KIT	<table border="1"> <thead> <tr> <th>Code</th> <th>Description</th> <th>Qty</th> <th>UOM</th> </tr> </thead> <tbody> <tr> <td>GN1326A1</td> <td>ELEMENT SEALING</td> <td>1</td> <td>PZ</td> </tr> <tr> <td>RS1011A0</td> <td>2560W 220-230V HEATING ELEMENT</td> <td>1</td> <td>PZ</td> </tr> <tr> <td>SL1045A0</td> <td>S57 BLACK SILICONE - 80ML CARTRIDGE</td> <td>1</td> <td>PZ</td> </tr> <tr> <td>VI1220A1</td> <td>4,2X12 TCB SELF-TAPPIN G SCREW</td> <td>5</td> <td>PZ</td> </tr> </tbody> </table>	Code	Description	Qty	UOM	GN1326A1	ELEMENT SEALING	1	PZ	RS1011A0	2560W 220-230V HEATING ELEMENT	1	PZ	SL1045A0	S57 BLACK SILICONE - 80ML CARTRIDGE	1	PZ	VI1220A1	4,2X12 TCB SELF-TAPPIN G SCREW	5	PZ								
Code	Description	Qty	UOM																											
GN1326A1	ELEMENT SEALING	1	PZ																											
RS1011A0	2560W 220-230V HEATING ELEMENT	1	PZ																											
SL1045A0	S57 BLACK SILICONE - 80ML CARTRIDGE	1	PZ																											
VI1220A1	4,2X12 TCB SELF-TAPPIN G SCREW	5	PZ																											

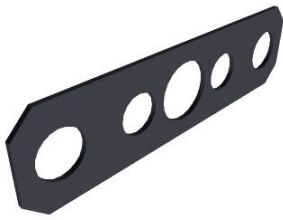

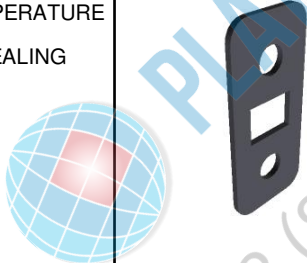
COMPONENT			SPARE PART																							
Code	Description	Image	Code	Description	Components list																					
GN1326A	ELEMENT SEALING		KRS1011A	ROBERTA/LISA HEATING ELEMENT KIT	<table border="1"> <thead> <tr> <th>Code</th> <th>Description</th> <th>Qty</th> <th>UOM</th> </tr> </thead> <tbody> <tr> <td>VM1794A0</td> <td>250X4.8 PA66 BLACK CLAMP</td> <td>2</td> <td>PZ</td> </tr> <tr> <td>VM2103A0</td> <td>CLAMP LOCK</td> <td>2</td> <td>PZ</td> </tr> </tbody> </table>	Code	Description	Qty	UOM	VM1794A0	250X4.8 PA66 BLACK CLAMP	2	PZ	VM2103A0	CLAMP LOCK	2	PZ									
			Code	Description	Qty	UOM																				
			VM1794A0	250X4.8 PA66 BLACK CLAMP	2	PZ																				
VM2103A0	CLAMP LOCK	2	PZ																							
KRS0090A	HEATING ELEMENT 1.26KW	<table border="1"> <thead> <tr> <th>Code</th> <th>Description</th> <th>Qty</th> <th>UOM</th> </tr> </thead> <tbody> <tr> <td>GN1326A1</td> <td>ELEMENT SEALING</td> <td>1</td> <td>PZ</td> </tr> <tr> <td>RS0090A0</td> <td>CIRC. HEAT. ELEMENT 1260W 220-230</td> <td>1</td> <td>PZ</td> </tr> <tr> <td>VI1220A1</td> <td>4,2X12 TCB SELF-TAPPIN G SCREW</td> <td>3</td> <td>PZ</td> </tr> <tr> <td>VM1794A0</td> <td>250X4.8 PA66 BLACK CLAMP</td> <td>2</td> <td>PZ</td> </tr> <tr> <td>VM2103A0</td> <td>CLAMP LOCK</td> <td>2</td> <td>PZ</td> </tr> </tbody> </table>	Code	Description	Qty	UOM	GN1326A1	ELEMENT SEALING	1	PZ	RS0090A0	CIRC. HEAT. ELEMENT 1260W 220-230	1	PZ	VI1220A1	4,2X12 TCB SELF-TAPPIN G SCREW	3	PZ	VM1794A0	250X4.8 PA66 BLACK CLAMP	2	PZ	VM2103A0	CLAMP LOCK	2	PZ
Code	Description	Qty	UOM																							
GN1326A1	ELEMENT SEALING	1	PZ																							
RS0090A0	CIRC. HEAT. ELEMENT 1260W 220-230	1	PZ																							
VI1220A1	4,2X12 TCB SELF-TAPPIN G SCREW	3	PZ																							
VM1794A0	250X4.8 PA66 BLACK CLAMP	2	PZ																							
VM2103A0	CLAMP LOCK	2	PZ																							
KRS0050A	HEATING ELEMENT KIT 0.5KW	<table border="1"> <thead> <tr> <th>Code</th> <th>Description</th> <th>Qty</th> <th>UOM</th> </tr> </thead> <tbody> <tr> <td>GN1326A1</td> <td>ELEMENT SEALING</td> <td>1</td> <td>PZ</td> </tr> <tr> <td>IP1075A1</td> <td></td> <td>1</td> <td>PZ</td> </tr> <tr> <td>IP1080A1</td> <td></td> <td>1</td> <td>PZ</td> </tr> <tr> <td>RS0050A0</td> <td>HEAT. ELEMENT 500W 220-230V LIEV</td> <td>1</td> <td>PZ</td> </tr> <tr> <td>VI1220A1</td> <td>4,2X12 TCB SELF-TAPPIN G SCREW</td> <td>2</td> <td>PZ</td> </tr> </tbody> </table>	Code	Description	Qty	UOM	GN1326A1	ELEMENT SEALING	1	PZ	IP1075A1		1	PZ	IP1080A1		1	PZ	RS0050A0	HEAT. ELEMENT 500W 220-230V LIEV	1	PZ	VI1220A1	4,2X12 TCB SELF-TAPPIN G SCREW	2	PZ
Code	Description	Qty	UOM																							
GN1326A1	ELEMENT SEALING	1	PZ																							
IP1075A1		1	PZ																							
IP1080A1		1	PZ																							
RS0050A0	HEAT. ELEMENT 500W 220-230V LIEV	1	PZ																							
VI1220A1	4,2X12 TCB SELF-TAPPIN G SCREW	2	PZ																							
KRS0011A	HEATING ELEMENT 1.465KW RS0011A	<table border="1"> <thead> <tr> <th>Code</th> <th>Description</th> <th>Qty</th> <th>UOM</th> </tr> </thead> <tbody> <tr> <td>GN1326A1</td> <td>ELEMENT SEALING</td> <td>1</td> <td>PZ</td> </tr> <tr> <td>RS0011A0</td> <td>CIRC.HEAT. ELEMENT 1465W 220-230</td> <td>1</td> <td>PZ</td> </tr> <tr> <td>VI1220A1</td> <td>4,2X12 TCB SELF-TAPPIN G SCREW</td> <td>3</td> <td>PZ</td> </tr> <tr> <td>VM1794A0</td> <td>250X4.8 PA66 BLACK CLAMP</td> <td>2</td> <td>PZ</td> </tr> <tr> <td>VM2103A0</td> <td>CLAMP LOCK</td> <td>2</td> <td>PZ</td> </tr> </tbody> </table>	Code	Description	Qty	UOM	GN1326A1	ELEMENT SEALING	1	PZ	RS0011A0	CIRC.HEAT. ELEMENT 1465W 220-230	1	PZ	VI1220A1	4,2X12 TCB SELF-TAPPIN G SCREW	3	PZ	VM1794A0	250X4.8 PA66 BLACK CLAMP	2	PZ	VM2103A0	CLAMP LOCK	2	PZ
Code	Description	Qty	UOM																							
GN1326A1	ELEMENT SEALING	1	PZ																							
RS0011A0	CIRC.HEAT. ELEMENT 1465W 220-230	1	PZ																							
VI1220A1	4,2X12 TCB SELF-TAPPIN G SCREW	3	PZ																							
VM1794A0	250X4.8 PA66 BLACK CLAMP	2	PZ																							
VM2103A0	CLAMP LOCK	2	PZ																							
KRS0010A	KIT HEATING ELEMENT RS10010A	<table border="1"> <thead> <tr> <th>Code</th> <th>Description</th> <th>Qty</th> <th>UOM</th> </tr> </thead> <tbody> <tr> <td>GN1326A1</td> <td>ELEMENT SEALING</td> <td>1</td> <td>PZ</td> </tr> <tr> <td>IP1075A1</td> <td></td> <td>1</td> <td>PZ</td> </tr> <tr> <td>IP1080A1</td> <td></td> <td>5</td> <td>PZ</td> </tr> <tr> <td>RS0010A0</td> <td>CIRC.HEAT. ELEMENT 2560W - 220-230 V</td> <td>1</td> <td>PZ</td> </tr> <tr> <td>VI1220A1</td> <td>4,2X12 TCB SELF-TAPPIN G SCREW</td> <td>3</td> <td>PZ</td> </tr> </tbody> </table>	Code	Description	Qty	UOM	GN1326A1	ELEMENT SEALING	1	PZ	IP1075A1		1	PZ	IP1080A1		5	PZ	RS0010A0	CIRC.HEAT. ELEMENT 2560W - 220-230 V	1	PZ	VI1220A1	4,2X12 TCB SELF-TAPPIN G SCREW	3	PZ
Code	Description	Qty	UOM																							
GN1326A1	ELEMENT SEALING	1	PZ																							
IP1075A1		1	PZ																							
IP1080A1		5	PZ																							
RS0010A0	CIRC.HEAT. ELEMENT 2560W - 220-230 V	1	PZ																							
VI1220A1	4,2X12 TCB SELF-TAPPIN G SCREW	3	PZ																							



COMPONENT			SPARE PART																														
Code	Description	Image	Code	Description	Components list																												
GN1326A	ELEMENT SEALING		KG1326A	HEATING ELEMENT GASKET 5 PCS KIT	<table border="1"> <thead> <tr> <th>Code</th> <th>Description</th> <th>Qty</th> <th>UOM</th> </tr> </thead> <tbody> <tr> <td>GN1326A1</td> <td>ELEMENT SEALING</td> <td>5</td> <td>PZ</td> </tr> </tbody> </table>	Code	Description	Qty	UOM	GN1326A1	ELEMENT SEALING	5	PZ																				
Code	Description	Qty	UOM																														
GN1326A1	ELEMENT SEALING	5	PZ																														
ASM0722A	Temperature probe		ASM0722A0	Temperature probe																													
GN1285A	NTC TEMPERATURE PROBE SEALING		KTR1106A	5-5E S. L2000 CHAMBER TEMP. PROBE KIT	<table border="1"> <thead> <tr> <th>Code</th> <th>Description</th> <th>Qty</th> <th>UOM</th> </tr> </thead> <tbody> <tr> <td>GN1285A0</td> <td>NTC TEMPERATUR E PROBE SEALING</td> <td>1</td> <td>PZ</td> </tr> <tr> <td>SL1045A0</td> <td>S57 BLACK SILICONE - 80ML CARTRIDGE</td> <td>1</td> <td>PZ</td> </tr> <tr> <td>TR1106A3</td> <td>PT100 L=2000 TEMPERATUR E PROBE</td> <td>1</td> <td>PZ</td> </tr> <tr> <td>VI1220A1</td> <td>4,2X12 TCB SELF-TAPPIN G SCREW</td> <td>2</td> <td>PZ</td> </tr> <tr> <td>VM1465A0</td> <td>CHEFTOP TEMPERATUR E PROBE COVER</td> <td>1</td> <td>PZ</td> </tr> </tbody> </table>	Code	Description	Qty	UOM	GN1285A0	NTC TEMPERATUR E PROBE SEALING	1	PZ	SL1045A0	S57 BLACK SILICONE - 80ML CARTRIDGE	1	PZ	TR1106A3	PT100 L=2000 TEMPERATUR E PROBE	1	PZ	VI1220A1	4,2X12 TCB SELF-TAPPIN G SCREW	2	PZ	VM1465A0	CHEFTOP TEMPERATUR E PROBE COVER	1	PZ				
Code	Description	Qty	UOM																														
GN1285A0	NTC TEMPERATUR E PROBE SEALING	1	PZ																														
SL1045A0	S57 BLACK SILICONE - 80ML CARTRIDGE	1	PZ																														
TR1106A3	PT100 L=2000 TEMPERATUR E PROBE	1	PZ																														
VI1220A1	4,2X12 TCB SELF-TAPPIN G SCREW	2	PZ																														
VM1465A0	CHEFTOP TEMPERATUR E PROBE COVER	1	PZ																														
			KTR1105A	PT100 L1000 TEMPERATURE PROBE KIT	<table border="1"> <thead> <tr> <th>Code</th> <th>Description</th> <th>Qty</th> <th>UOM</th> </tr> </thead> <tbody> <tr> <td>GN1120A0</td> <td>TEMPERATUR E PROBE NTC SEAL</td> <td>1</td> <td>PZ</td> </tr> <tr> <td>GN1120A1</td> <td></td> <td>1</td> <td>PZ</td> </tr> <tr> <td>GN1285A0</td> <td>NTC TEMPERATUR E PROBE SEALING</td> <td>1</td> <td>PZ</td> </tr> <tr> <td>SL1045A0</td> <td>S57 BLACK SILICONE - 80ML CARTRIDGE</td> <td>1</td> <td>PZ</td> </tr> <tr> <td>TR1105A4</td> <td></td> <td>1</td> <td>PZ</td> </tr> <tr> <td>VI1220A1</td> <td>4,2X12 TCB SELF-TAPPIN G SCREW</td> <td>2</td> <td>PZ</td> </tr> </tbody> </table>	Code	Description	Qty	UOM	GN1120A0	TEMPERATUR E PROBE NTC SEAL	1	PZ	GN1120A1		1	PZ	GN1285A0	NTC TEMPERATUR E PROBE SEALING	1	PZ	SL1045A0	S57 BLACK SILICONE - 80ML CARTRIDGE	1	PZ	TR1105A4		1	PZ	VI1220A1	4,2X12 TCB SELF-TAPPIN G SCREW	2	PZ
Code	Description	Qty	UOM																														
GN1120A0	TEMPERATUR E PROBE NTC SEAL	1	PZ																														
GN1120A1		1	PZ																														
GN1285A0	NTC TEMPERATUR E PROBE SEALING	1	PZ																														
SL1045A0	S57 BLACK SILICONE - 80ML CARTRIDGE	1	PZ																														
TR1105A4		1	PZ																														
VI1220A1	4,2X12 TCB SELF-TAPPIN G SCREW	2	PZ																														

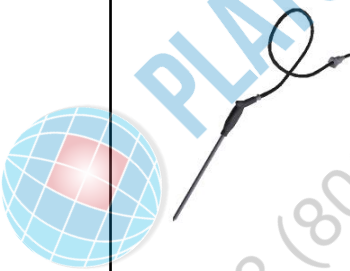

COMPONENT			SPARE PART																																		
Code	Description	Image	Code	Description	Components list																																
GN1285A	NTC TEMPERATURE PROBE SEALING		KTR1096A	NTC 150 L=1500 TEMPERATURE PROBE KIT	<table border="1"> <thead> <tr> <th>Code</th> <th>Description</th> <th>Qty</th> <th>UOM</th> </tr> </thead> <tbody> <tr> <td>GN1120A0</td> <td>TEMPERATUR E PROBE NTC SEAL</td> <td>1</td> <td>PZ</td> </tr> <tr> <td>GN1120A1</td> <td></td> <td>1</td> <td>PZ</td> </tr> <tr> <td>GN1285A0</td> <td>NTC TEMPERATUR E PROBE SEALING</td> <td>2</td> <td>PZ</td> </tr> <tr> <td>SL1045A0</td> <td>S57 BLACK SILICONE - 80ML CARTRIDGE</td> <td>1</td> <td>PZ</td> </tr> <tr> <td>TR1096A0</td> <td>TEMPERATUR E PROBE NTC 150 L=1500</td> <td>1</td> <td>PZ</td> </tr> <tr> <td>VI1220A1</td> <td>4,2X12 TCB SELF-TAPPIN G SCREW</td> <td>2</td> <td>PZ</td> </tr> <tr> <td>VM1465A0</td> <td>CHEFTOP TEMPERATUR E PROBE COVER</td> <td>1</td> <td>PZ</td> </tr> </tbody> </table>	Code	Description	Qty	UOM	GN1120A0	TEMPERATUR E PROBE NTC SEAL	1	PZ	GN1120A1		1	PZ	GN1285A0	NTC TEMPERATUR E PROBE SEALING	2	PZ	SL1045A0	S57 BLACK SILICONE - 80ML CARTRIDGE	1	PZ	TR1096A0	TEMPERATUR E PROBE NTC 150 L=1500	1	PZ	VI1220A1	4,2X12 TCB SELF-TAPPIN G SCREW	2	PZ	VM1465A0	CHEFTOP TEMPERATUR E PROBE COVER	1	PZ
			Code	Description	Qty	UOM																															
			GN1120A0	TEMPERATUR E PROBE NTC SEAL	1	PZ																															
GN1120A1		1	PZ																																		
GN1285A0	NTC TEMPERATUR E PROBE SEALING	2	PZ																																		
SL1045A0	S57 BLACK SILICONE - 80ML CARTRIDGE	1	PZ																																		
TR1096A0	TEMPERATUR E PROBE NTC 150 L=1500	1	PZ																																		
VI1220A1	4,2X12 TCB SELF-TAPPIN G SCREW	2	PZ																																		
VM1465A0	CHEFTOP TEMPERATUR E PROBE COVER	1	PZ																																		
KTR1095A	NTC 150 L=1050 TEMPERATURE PROBE KIT	<table border="1"> <thead> <tr> <th>Code</th> <th>Description</th> <th>Qty</th> <th>UOM</th> </tr> </thead> <tbody> <tr> <td>GN1120A0</td> <td>TEMPERATUR E PROBE NTC SEAL</td> <td>1</td> <td>PZ</td> </tr> <tr> <td>GN1120A1</td> <td></td> <td>1</td> <td>PZ</td> </tr> <tr> <td>GN1285A0</td> <td>NTC TEMPERATUR E PROBE SEALING</td> <td>1</td> <td>PZ</td> </tr> <tr> <td>SL1045A0</td> <td>S57 BLACK SILICONE - 80ML CARTRIDGE</td> <td>1</td> <td>PZ</td> </tr> <tr> <td>TR1095A0</td> <td>TEMPERATUR E PROBE NTC 150 L=1050</td> <td>1</td> <td>PZ</td> </tr> <tr> <td>VI1220A1</td> <td>4,2X12 TCB SELF-TAPPIN G SCREW</td> <td>2</td> <td>PZ</td> </tr> <tr> <td>VM1465A0</td> <td>CHEFTOP TEMPERATUR E PROBE COVER</td> <td>1</td> <td>PZ</td> </tr> </tbody> </table>	Code	Description	Qty	UOM	GN1120A0	TEMPERATUR E PROBE NTC SEAL	1	PZ	GN1120A1		1	PZ	GN1285A0	NTC TEMPERATUR E PROBE SEALING	1	PZ	SL1045A0	S57 BLACK SILICONE - 80ML CARTRIDGE	1	PZ	TR1095A0	TEMPERATUR E PROBE NTC 150 L=1050	1	PZ	VI1220A1	4,2X12 TCB SELF-TAPPIN G SCREW	2	PZ	VM1465A0	CHEFTOP TEMPERATUR E PROBE COVER	1	PZ			
Code	Description	Qty	UOM																																		
GN1120A0	TEMPERATUR E PROBE NTC SEAL	1	PZ																																		
GN1120A1		1	PZ																																		
GN1285A0	NTC TEMPERATUR E PROBE SEALING	1	PZ																																		
SL1045A0	S57 BLACK SILICONE - 80ML CARTRIDGE	1	PZ																																		
TR1095A0	TEMPERATUR E PROBE NTC 150 L=1050	1	PZ																																		
VI1220A1	4,2X12 TCB SELF-TAPPIN G SCREW	2	PZ																																		
VM1465A0	CHEFTOP TEMPERATUR E PROBE COVER	1	PZ																																		
KTR1002A	PT100 L1000 UL TEMPERATURE PROBE KIT	<table border="1"> <thead> <tr> <th>Code</th> <th>Description</th> <th>Qty</th> <th>UOM</th> </tr> </thead> <tbody> <tr> <td>GN1285A0</td> <td>NTC TEMPERATUR E PROBE SEALING</td> <td>2</td> <td>PZ</td> </tr> </tbody> </table>	Code	Description	Qty	UOM	GN1285A0	NTC TEMPERATUR E PROBE SEALING	2	PZ																											
Code	Description	Qty	UOM																																		
GN1285A0	NTC TEMPERATUR E PROBE SEALING	2	PZ																																		

COMPONENT			SPARE PART																														
Code	Description	Image	Code	Description	Components list																												
GN1285A	NTC TEMPERATURE PROBE SEALING		KTR1002A	PT100 L1000 UL TEMPERATURE PROBE KIT	<table border="1"> <thead> <tr> <th>Code</th> <th>Description</th> <th>Qty</th> <th>UOM</th> </tr> </thead> <tbody> <tr> <td>SL1045A0</td> <td>S57 BLACK SILICONE - 80ML CARTRIDGE</td> <td>1</td> <td>PZ</td> </tr> <tr> <td>TR1002A1</td> <td></td> <td>1</td> <td>PZ</td> </tr> <tr> <td>VI1220A1</td> <td>4,2X12 TCB SELF-TAPPIN G SCREW</td> <td>2</td> <td>PZ</td> </tr> <tr> <td>VM1465A0</td> <td>CHEFTOP TEMPERATUR E PROBE COVER</td> <td>1</td> <td>PZ</td> </tr> </tbody> </table>	Code	Description	Qty	UOM	SL1045A0	S57 BLACK SILICONE - 80ML CARTRIDGE	1	PZ	TR1002A1		1	PZ	VI1220A1	4,2X12 TCB SELF-TAPPIN G SCREW	2	PZ	VM1465A0	CHEFTOP TEMPERATUR E PROBE COVER	1	PZ								
Code	Description	Qty	UOM																														
SL1045A0	S57 BLACK SILICONE - 80ML CARTRIDGE	1	PZ																														
TR1002A1		1	PZ																														
VI1220A1	4,2X12 TCB SELF-TAPPIN G SCREW	2	PZ																														
VM1465A0	CHEFTOP TEMPERATUR E PROBE COVER	1	PZ																														
TR1106A	PT100 L=2000 TEMPERATURE PROBE		KTR1106B	MIND.MAPS L2000 CHAMBER TEMP. PROBE KIT	<table border="1"> <thead> <tr> <th>Code</th> <th>Description</th> <th>Qty</th> <th>UOM</th> </tr> </thead> <tbody> <tr> <td>GN1285A0</td> <td>NTC TEMPERATUR E PROBE SEALING</td> <td>1</td> <td>PZ</td> </tr> <tr> <td>SL1045A0</td> <td>S57 BLACK SILICONE - 80ML CARTRIDGE</td> <td>1</td> <td>PZ</td> </tr> <tr> <td>TR1106B0</td> <td></td> <td>1</td> <td>PZ</td> </tr> <tr> <td>VI1220A1</td> <td>4,2X12 TCB SELF-TAPPIN G SCREW</td> <td>2</td> <td>PZ</td> </tr> <tr> <td>VM1464A1</td> <td>CT BT TEMPERATUR E PROBE COVER</td> <td>1</td> <td>PZ</td> </tr> <tr> <td>VM1465A0</td> <td>CHEFTOP TEMPERATUR E PROBE COVER</td> <td>1</td> <td>PZ</td> </tr> </tbody> </table>	Code	Description	Qty	UOM	GN1285A0	NTC TEMPERATUR E PROBE SEALING	1	PZ	SL1045A0	S57 BLACK SILICONE - 80ML CARTRIDGE	1	PZ	TR1106B0		1	PZ	VI1220A1	4,2X12 TCB SELF-TAPPIN G SCREW	2	PZ	VM1464A1	CT BT TEMPERATUR E PROBE COVER	1	PZ	VM1465A0	CHEFTOP TEMPERATUR E PROBE COVER	1	PZ
Code	Description	Qty	UOM																														
GN1285A0	NTC TEMPERATUR E PROBE SEALING	1	PZ																														
SL1045A0	S57 BLACK SILICONE - 80ML CARTRIDGE	1	PZ																														
TR1106B0		1	PZ																														
VI1220A1	4,2X12 TCB SELF-TAPPIN G SCREW	2	PZ																														
VM1464A1	CT BT TEMPERATUR E PROBE COVER	1	PZ																														
VM1465A0	CHEFTOP TEMPERATUR E PROBE COVER	1	PZ																														
			KTR1106A	5-5E S. L2000 CHAMBER TEMP. PROBE KIT	<table border="1"> <thead> <tr> <th>Code</th> <th>Description</th> <th>Qty</th> <th>UOM</th> </tr> </thead> <tbody> <tr> <td>GN1285A0</td> <td>NTC TEMPERATUR E PROBE SEALING</td> <td>1</td> <td>PZ</td> </tr> <tr> <td>SL1045A0</td> <td>S57 BLACK SILICONE - 80ML CARTRIDGE</td> <td>1</td> <td>PZ</td> </tr> <tr> <td>TR1106A3</td> <td>PT100 L=2000 TEMPERATUR E PROBE</td> <td>1</td> <td>PZ</td> </tr> <tr> <td>VI1220A1</td> <td>4,2X12 TCB SELF-TAPPIN G SCREW</td> <td>2</td> <td>PZ</td> </tr> <tr> <td>VM1465A0</td> <td>CHEFTOP TEMPERATUR E PROBE COVER</td> <td>1</td> <td>PZ</td> </tr> </tbody> </table>	Code	Description	Qty	UOM	GN1285A0	NTC TEMPERATUR E PROBE SEALING	1	PZ	SL1045A0	S57 BLACK SILICONE - 80ML CARTRIDGE	1	PZ	TR1106A3	PT100 L=2000 TEMPERATUR E PROBE	1	PZ	VI1220A1	4,2X12 TCB SELF-TAPPIN G SCREW	2	PZ	VM1465A0	CHEFTOP TEMPERATUR E PROBE COVER	1	PZ				
Code	Description	Qty	UOM																														
GN1285A0	NTC TEMPERATUR E PROBE SEALING	1	PZ																														
SL1045A0	S57 BLACK SILICONE - 80ML CARTRIDGE	1	PZ																														
TR1106A3	PT100 L=2000 TEMPERATUR E PROBE	1	PZ																														
VI1220A1	4,2X12 TCB SELF-TAPPIN G SCREW	2	PZ																														
VM1465A0	CHEFTOP TEMPERATUR E PROBE COVER	1	PZ																														

COMPONENT			SPARE PART																														
Code	Description	Image	Code	Description	Components list																												
VM1464A	CT BT TEMPERATURE PROBE COVER		KVM1464A	CT BT TEMPERATURE PROBE COVER KIT	<table border="1"> <thead> <tr> <th>Code</th> <th>Description</th> <th>Qty</th> <th>UOM</th> </tr> </thead> <tbody> <tr> <td>VM1464A1</td> <td>CT BT TEMPERATUR E PROBE COVER</td> <td>1</td> <td>PZ</td> </tr> </tbody> </table>	Code	Description	Qty	UOM	VM1464A1	CT BT TEMPERATUR E PROBE COVER	1	PZ																				
Code	Description	Qty	UOM																														
VM1464A1	CT BT TEMPERATUR E PROBE COVER	1	PZ																														
GN1531A	THERMOSTAT BULB INLET SEALING		KTR1136A	330 °C SAFETY THERMOSTAT KIT	<table border="1"> <thead> <tr> <th>Code</th> <th>Description</th> <th>Qty</th> <th>UOM</th> </tr> </thead> <tbody> <tr> <td>0H7030A0</td> <td>THERMOSTAT BULB INLET COVER</td> <td>1</td> <td>PZ</td> </tr> <tr> <td>GN1531A0</td> <td>THERMOSTAT BULB INLET SEALING</td> <td>1</td> <td>PZ</td> </tr> <tr> <td>SL1045A0</td> <td>S57 BLACK SILICONE - 80ML CARTRIDGE</td> <td>1</td> <td>PZ</td> </tr> <tr> <td>TR1136A0</td> <td>330 °C 1 POLE SAFETY THERMOSTAT</td> <td>1</td> <td>PZ</td> </tr> <tr> <td>V11220A1</td> <td>4,2X12 TCB SELF-TAPPIN G SCREW</td> <td>3</td> <td>PZ</td> </tr> </tbody> </table>	Code	Description	Qty	UOM	0H7030A0	THERMOSTAT BULB INLET COVER	1	PZ	GN1531A0	THERMOSTAT BULB INLET SEALING	1	PZ	SL1045A0	S57 BLACK SILICONE - 80ML CARTRIDGE	1	PZ	TR1136A0	330 °C 1 POLE SAFETY THERMOSTAT	1	PZ	V11220A1	4,2X12 TCB SELF-TAPPIN G SCREW	3	PZ				
Code	Description	Qty	UOM																														
0H7030A0	THERMOSTAT BULB INLET COVER	1	PZ																														
GN1531A0	THERMOSTAT BULB INLET SEALING	1	PZ																														
SL1045A0	S57 BLACK SILICONE - 80ML CARTRIDGE	1	PZ																														
TR1136A0	330 °C 1 POLE SAFETY THERMOSTAT	1	PZ																														
V11220A1	4,2X12 TCB SELF-TAPPIN G SCREW	3	PZ																														
0H7030A	THERMOSTAT BULB INLET COVER		K0H7030A	THERMOSTAT BULB INLET COVER KIT	<table border="1"> <thead> <tr> <th>Code</th> <th>Description</th> <th>Qty</th> <th>UOM</th> </tr> </thead> <tbody> <tr> <td>0H7030A0</td> <td>THERMOSTAT BULB INLET COVER</td> <td>1</td> <td>PZ</td> </tr> </tbody> </table>	Code	Description	Qty	UOM	0H7030A0	THERMOSTAT BULB INLET COVER	1	PZ																				
Code	Description	Qty	UOM																														
0H7030A0	THERMOSTAT BULB INLET COVER	1	PZ																														
GRL1390A	5 GN1/1 LEFT LATERAL SUPPORT		KGRL1390A	MIND.MAPS 5 GN1/1 LATERAL SUPPORTS KIT	<table border="1"> <thead> <tr> <th>Code</th> <th>Description</th> <th>Qty</th> <th>UOM</th> </tr> </thead> <tbody> <tr> <td>0H4420A0</td> <td>STAINLESS STEEL CORE TEMPERATUR</td> <td>1</td> <td>PZ</td> </tr> <tr> <td>0H7300A0</td> <td>0H7308+0H730 9 FLAT SUPPORTING PROFILE</td> <td>2</td> <td>PZ</td> </tr> <tr> <td>0H7301A0</td> <td>0H7310+0H731 1 FLAT SUPPORTING PROFILE</td> <td>2</td> <td>PZ</td> </tr> <tr> <td>0H7797A0</td> <td></td> <td>10</td> <td>PZ</td> </tr> <tr> <td>IP1508A1</td> <td>POLYSTYREN E U SHAPED PROFILE 2000X60X60</td> <td>2</td> <td>M</td> </tr> <tr> <td>VM1059A1</td> <td>HEAT SHRINK FILM H800</td> <td>1.500</td> <td>M</td> </tr> </tbody> </table>	Code	Description	Qty	UOM	0H4420A0	STAINLESS STEEL CORE TEMPERATUR	1	PZ	0H7300A0	0H7308+0H730 9 FLAT SUPPORTING PROFILE	2	PZ	0H7301A0	0H7310+0H731 1 FLAT SUPPORTING PROFILE	2	PZ	0H7797A0		10	PZ	IP1508A1	POLYSTYREN E U SHAPED PROFILE 2000X60X60	2	M	VM1059A1	HEAT SHRINK FILM H800	1.500	M
Code	Description	Qty	UOM																														
0H4420A0	STAINLESS STEEL CORE TEMPERATUR	1	PZ																														
0H7300A0	0H7308+0H730 9 FLAT SUPPORTING PROFILE	2	PZ																														
0H7301A0	0H7310+0H731 1 FLAT SUPPORTING PROFILE	2	PZ																														
0H7797A0		10	PZ																														
IP1508A1	POLYSTYREN E U SHAPED PROFILE 2000X60X60	2	M																														
VM1059A1	HEAT SHRINK FILM H800	1.500	M																														

COMPONENT			SPARE PART																														
Code	Description	Image	Code	Description	Components list																												
GRL1389A	5 GN1/1 RIGHT LATERAL SUPPORT		KGRL1390A	MIND.MAPS 5 GN1/1 LATERAL SUPPORTS KIT	<table border="1"> <thead> <tr> <th>Code</th> <th>Description</th> <th>Qty</th> <th>UOM</th> </tr> </thead> <tbody> <tr> <td>0H4420A0</td> <td>STAINLESS STEEL CORE TEMPERATUR</td> <td>1</td> <td>PZ</td> </tr> <tr> <td>0H7300A0</td> <td>0H7308+0H730 9 FLAT SUPPORTING PROFILE</td> <td>2</td> <td>PZ</td> </tr> <tr> <td>0H7301A0</td> <td>0H7310+0H731 1 FLAT SUPPORTING PROFILE</td> <td>2</td> <td>PZ</td> </tr> <tr> <td>0H7797A0</td> <td></td> <td>10</td> <td>PZ</td> </tr> <tr> <td>IP1508A1</td> <td>POLYSTYREN E U SHAPED PROFILE 2000X60X60</td> <td>2</td> <td>M</td> </tr> <tr> <td>VM1059A1</td> <td>HEAT SHRINK FILM H800</td> <td>1.500</td> <td>M</td> </tr> </tbody> </table>	Code	Description	Qty	UOM	0H4420A0	STAINLESS STEEL CORE TEMPERATUR	1	PZ	0H7300A0	0H7308+0H730 9 FLAT SUPPORTING PROFILE	2	PZ	0H7301A0	0H7310+0H731 1 FLAT SUPPORTING PROFILE	2	PZ	0H7797A0		10	PZ	IP1508A1	POLYSTYREN E U SHAPED PROFILE 2000X60X60	2	M	VM1059A1	HEAT SHRINK FILM H800	1.500	M
Code	Description	Qty	UOM																														
0H4420A0	STAINLESS STEEL CORE TEMPERATUR	1	PZ																														
0H7300A0	0H7308+0H730 9 FLAT SUPPORTING PROFILE	2	PZ																														
0H7301A0	0H7310+0H731 1 FLAT SUPPORTING PROFILE	2	PZ																														
0H7797A0		10	PZ																														
IP1508A1	POLYSTYREN E U SHAPED PROFILE 2000X60X60	2	M																														
VM1059A1	HEAT SHRINK FILM H800	1.500	M																														
SN1000A			KSN1019A	US MULTI.POINT L1550 CORE PROBE KIT	<table border="1"> <thead> <tr> <th>Code</th> <th>Description</th> <th>Qty</th> <th>UOM</th> </tr> </thead> <tbody> <tr> <td>CE1037A0</td> <td>UL SILICON GLASS FIBER SHEATH</td> <td>0.600</td> <td>M</td> </tr> <tr> <td>CE1685A0</td> <td>MRT8 P3,81 5 POLES FEMALE TERMINAL</td> <td>1</td> <td>PZ</td> </tr> <tr> <td>RC1130A0</td> <td>130X2,6 CLAM</td> <td>2</td> <td>PZ</td> </tr> <tr> <td>SN1000A3</td> <td>MULTI.POINT CORE PROBE L1550</td> <td>1</td> <td>PZ</td> </tr> <tr> <td>SN1000A4</td> <td>MULTI.POINT CORE PROBE L1550</td> <td>1</td> <td>PZ</td> </tr> <tr> <td>SN1000A5</td> <td>MULTI.POINT CORE PROBE L1550</td> <td>1</td> <td>PZ</td> </tr> </tbody> </table>	Code	Description	Qty	UOM	CE1037A0	UL SILICON GLASS FIBER SHEATH	0.600	M	CE1685A0	MRT8 P3,81 5 POLES FEMALE TERMINAL	1	PZ	RC1130A0	130X2,6 CLAM	2	PZ	SN1000A3	MULTI.POINT CORE PROBE L1550	1	PZ	SN1000A4	MULTI.POINT CORE PROBE L1550	1	PZ	SN1000A5	MULTI.POINT CORE PROBE L1550	1	PZ
Code	Description	Qty	UOM																														
CE1037A0	UL SILICON GLASS FIBER SHEATH	0.600	M																														
CE1685A0	MRT8 P3,81 5 POLES FEMALE TERMINAL	1	PZ																														
RC1130A0	130X2,6 CLAM	2	PZ																														
SN1000A3	MULTI.POINT CORE PROBE L1550	1	PZ																														
SN1000A4	MULTI.POINT CORE PROBE L1550	1	PZ																														
SN1000A5	MULTI.POINT CORE PROBE L1550	1	PZ																														
			KSN1000A	MULTIPOINT CORE PROBE KIT L1550	<table border="1"> <thead> <tr> <th>Code</th> <th>Description</th> <th>Qty</th> <th>UOM</th> </tr> </thead> <tbody> <tr> <td>CE1685A0</td> <td>MRT8 P3,81 5 POLES FEMALE TERMINAL</td> <td>1</td> <td>PZ</td> </tr> <tr> <td>SN1000A3</td> <td>MULTI.POINT CORE PROBE L1550</td> <td>1</td> <td>PZ</td> </tr> <tr> <td>SN1000A4</td> <td>MULTI.POINT CORE PROBE L1550</td> <td>1</td> <td>PZ</td> </tr> <tr> <td>SN1000A5</td> <td>MULTI.POINT CORE PROBE L1550</td> <td>1</td> <td>PZ</td> </tr> </tbody> </table>	Code	Description	Qty	UOM	CE1685A0	MRT8 P3,81 5 POLES FEMALE TERMINAL	1	PZ	SN1000A3	MULTI.POINT CORE PROBE L1550	1	PZ	SN1000A4	MULTI.POINT CORE PROBE L1550	1	PZ	SN1000A5	MULTI.POINT CORE PROBE L1550	1	PZ								
Code	Description	Qty	UOM																														
CE1685A0	MRT8 P3,81 5 POLES FEMALE TERMINAL	1	PZ																														
SN1000A3	MULTI.POINT CORE PROBE L1550	1	PZ																														
SN1000A4	MULTI.POINT CORE PROBE L1550	1	PZ																														
SN1000A5	MULTI.POINT CORE PROBE L1550	1	PZ																														

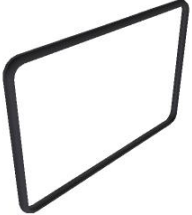
COMPONENT			SPARE PART																																										
Code	Description	Image	Code	Description	Components list																																								
VL1037A	WASHING SYSTEM ROTOR		KVL1037A	WASHING SYSTEM ROTOR KIT	<table border="1"> <thead> <tr> <th>Code</th> <th>Description</th> <th>Qty</th> <th>UOM</th> </tr> </thead> <tbody> <tr> <td>GN1416B0</td> <td>WASHING SYSTEM ROTOR BEARING</td> <td>1</td> <td>PZ</td> </tr> <tr> <td>TF1065B0</td> <td>WASHING SYSTEM ROTOR PIVOT</td> <td>1</td> <td>PZ</td> </tr> <tr> <td>TF1066A1</td> <td>WASHING SYSTEM ROTOR BUSH</td> <td>1</td> <td>PZ</td> </tr> <tr> <td>UG1005B1</td> <td>LONG RAY ROTOR WATER NOZZL</td> <td>1</td> <td>PZ</td> </tr> <tr> <td>UG1006B3</td> <td>LONG RAY ROTOR WATER NOZZL</td> <td>1</td> <td>PZ</td> </tr> <tr> <td>VI1220A1</td> <td>4,2X12 TCB SELF-TAPPIN G SCREW</td> <td>8</td> <td>PZ</td> </tr> <tr> <td>VM1955C0</td> <td>WASHING SYSTEM ROTOR</td> <td>1</td> <td>PZ</td> </tr> <tr> <td>VM1985C1</td> <td>WASHING SYSTEM ROTOR COVE</td> <td>1</td> <td>PZ</td> </tr> <tr> <td>VM1986A0</td> <td>NOZZLE COVE</td> <td>2</td> <td>PZ</td> </tr> </tbody> </table>	Code	Description	Qty	UOM	GN1416B0	WASHING SYSTEM ROTOR BEARING	1	PZ	TF1065B0	WASHING SYSTEM ROTOR PIVOT	1	PZ	TF1066A1	WASHING SYSTEM ROTOR BUSH	1	PZ	UG1005B1	LONG RAY ROTOR WATER NOZZL	1	PZ	UG1006B3	LONG RAY ROTOR WATER NOZZL	1	PZ	VI1220A1	4,2X12 TCB SELF-TAPPIN G SCREW	8	PZ	VM1955C0	WASHING SYSTEM ROTOR	1	PZ	VM1985C1	WASHING SYSTEM ROTOR COVE	1	PZ	VM1986A0	NOZZLE COVE	2	PZ
Code	Description	Qty	UOM																																										
GN1416B0	WASHING SYSTEM ROTOR BEARING	1	PZ																																										
TF1065B0	WASHING SYSTEM ROTOR PIVOT	1	PZ																																										
TF1066A1	WASHING SYSTEM ROTOR BUSH	1	PZ																																										
UG1005B1	LONG RAY ROTOR WATER NOZZL	1	PZ																																										
UG1006B3	LONG RAY ROTOR WATER NOZZL	1	PZ																																										
VI1220A1	4,2X12 TCB SELF-TAPPIN G SCREW	8	PZ																																										
VM1955C0	WASHING SYSTEM ROTOR	1	PZ																																										
VM1985C1	WASHING SYSTEM ROTOR COVE	1	PZ																																										
VM1986A0	NOZZLE COVE	2	PZ																																										
0H2551A	XBC/XVC ST.STEEL DRAIN COVER		K0H2551A	DRAIN COVER KIT	<table border="1"> <thead> <tr> <th>Code</th> <th>Description</th> <th>Qty</th> <th>UOM</th> </tr> </thead> <tbody> <tr> <td>0H2551A0</td> <td>XBC/XVC ST.STEEL DRAIN COVER</td> <td>1</td> <td>PZ</td> </tr> </tbody> </table>	Code	Description	Qty	UOM	0H2551A0	XBC/XVC ST.STEEL DRAIN COVER	1	PZ																																
Code	Description	Qty	UOM																																										
0H2551A0	XBC/XVC ST.STEEL DRAIN COVER	1	PZ																																										
0H7320A			OUTOFPRODUCTIO																																										

COMPONENT			SPARE PART																		
Code	Description	Image	Code	Description	Components list																
GN1563A	0511 DOOR GASKET		KGN1629A	0511 DOOR GASKET KIT	<table border="1"> <thead> <tr> <th>Code</th> <th>Description</th> <th>Qty</th> <th>UOM</th> </tr> </thead> <tbody> <tr> <td>GN1626A0</td> <td>DOUBLE LIP-TYPE FRONT GASKE</td> <td>1.900</td> <td>M</td> </tr> <tr> <td>SL1025A0</td> <td>CLEAR SILICON DOW CORNING 734</td> <td>0.012</td> <td>PZ</td> </tr> <tr> <td>VM2277A0</td> <td>DOOR SEAL KIT INTERNAL CONNECTION</td> <td>1</td> <td>PZ</td> </tr> </tbody> </table>	Code	Description	Qty	UOM	GN1626A0	DOUBLE LIP-TYPE FRONT GASKE	1.900	M	SL1025A0	CLEAR SILICON DOW CORNING 734	0.012	PZ	VM2277A0	DOOR SEAL KIT INTERNAL CONNECTION	1	PZ
Code	Description	Qty	UOM																		
GN1626A0	DOUBLE LIP-TYPE FRONT GASKE	1.900	M																		
SL1025A0	CLEAR SILICON DOW CORNING 734	0.012	PZ																		
VM2277A0	DOOR SEAL KIT INTERNAL CONNECTION	1	PZ																		
VM1820A	LATERAL SUPPORTS M6 FIXING BOLT		KVM1820A	THUMB SCREW 10PCS KIT	<table border="1"> <thead> <tr> <th>Code</th> <th>Description</th> <th>Qty</th> <th>UOM</th> </tr> </thead> <tbody> <tr> <td>VM1820A0</td> <td>LATERAL SUPPORTS M6 FIXING BOLT</td> <td>10</td> <td>PZ</td> </tr> </tbody> </table>	Code	Description	Qty	UOM	VM1820A0	LATERAL SUPPORTS M6 FIXING BOLT	10	PZ								
Code	Description	Qty	UOM																		
VM1820A0	LATERAL SUPPORTS M6 FIXING BOLT	10	PZ																		
OG1558A	FAN GUARD SPACE		KOG1558A	SPACER FAN GUARD KIT	<table border="1"> <thead> <tr> <th>Code</th> <th>Description</th> <th>Qty</th> <th>UOM</th> </tr> </thead> <tbody> <tr> <td>OG1558A0</td> <td>FAN GUARD SPACER</td> <td>1</td> <td>PZ</td> </tr> <tr> <td>IP1508A1</td> <td>POLYSTYREN E U SHAPED PROFILE 2000X60X60</td> <td>1.400</td> <td>M</td> </tr> <tr> <td>VM1059A1</td> <td>HEAT SHRINK FILM H800</td> <td>1.500</td> <td>M</td> </tr> </tbody> </table>	Code	Description	Qty	UOM	OG1558A0	FAN GUARD SPACER	1	PZ	IP1508A1	POLYSTYREN E U SHAPED PROFILE 2000X60X60	1.400	M	VM1059A1	HEAT SHRINK FILM H800	1.500	M
Code	Description	Qty	UOM																		
OG1558A0	FAN GUARD SPACER	1	PZ																		
IP1508A1	POLYSTYREN E U SHAPED PROFILE 2000X60X60	1.400	M																		
VM1059A1	HEAT SHRINK FILM H800	1.500	M																		
RC1170A	STAINLESS STEEL NUT M14 H=8 CH=22		KRC1170A	M14 H8 CH22 NUT - 10 PCS. KIT	<table border="1"> <thead> <tr> <th>Code</th> <th>Description</th> <th>Qty</th> <th>UOM</th> </tr> </thead> <tbody> <tr> <td>RC1170A1</td> <td>STAINLESS STEEL NUT M14 H=8 CH=2</td> <td>10</td> <td>PZ</td> </tr> </tbody> </table>	Code	Description	Qty	UOM	RC1170A1	STAINLESS STEEL NUT M14 H=8 CH=2	10	PZ								
Code	Description	Qty	UOM																		
RC1170A1	STAINLESS STEEL NUT M14 H=8 CH=2	10	PZ																		
ASM1748A	General overview		ASM1748A0	General overview																	



COMPONENT			SPARE PART														
Code	Description	Image	Code	Description	Components list												
VM2344A	ANTISCALE MAGNET HOLDER HALF COVER		KVM2344A	ANTI-LIMESCALE MAGNET HALF BEARING KIT	<table border="1"> <thead> <tr> <th>Code</th> <th>Description</th> <th>Qty</th> <th>UOM</th> </tr> </thead> <tbody> <tr> <td>VM2344A0</td> <td>ANTISCALE MAGNET HOLDER HALF COVER</td> <td>2</td> <td>PZ</td> </tr> <tr> <td>VM2344A0</td> <td>ANTISCALE MAGNET HOLDER HALF COVER</td> <td>2</td> <td>PZ</td> </tr> </tbody> </table>	Code	Description	Qty	UOM	VM2344A0	ANTISCALE MAGNET HOLDER HALF COVER	2	PZ	VM2344A0	ANTISCALE MAGNET HOLDER HALF COVER	2	PZ
Code	Description	Qty	UOM														
VM2344A0	ANTISCALE MAGNET HOLDER HALF COVER	2	PZ														
VM2344A0	ANTISCALE MAGNET HOLDER HALF COVER	2	PZ														
VL1086A	LIMESCALE REMOVER NEODYMIUM MAGNET		KVL1086A	NEODYMIUM MAGNET ANTI-LIMESCALE KI	<table border="1"> <thead> <tr> <th>Code</th> <th>Description</th> <th>Qty</th> <th>UOM</th> </tr> </thead> <tbody> <tr> <td>VL1086A0</td> <td>LIMESCALE REMOVER NEODYMIUM MAGNET</td> <td>2</td> <td>PZ</td> </tr> </tbody> </table>	Code	Description	Qty	UOM	VL1086A0	LIMESCALE REMOVER NEODYMIUM MAGNET	2	PZ				
Code	Description	Qty	UOM														
VL1086A0	LIMESCALE REMOVER NEODYMIUM MAGNET	2	PZ														
EL1361A	D8-D10 J.G. STEAM SOLENOID VALVE		KEL1361A	D8-D10 STEAM SOLENOID VALVE KI	<table border="1"> <thead> <tr> <th>Code</th> <th>Description</th> <th>Qty</th> <th>UOM</th> </tr> </thead> <tbody> <tr> <td>EL1361A0</td> <td>D8-D10 J.G. STEAM SOLENOID VALVE</td> <td>1</td> <td>PZ</td> </tr> </tbody> </table>	Code	Description	Qty	UOM	EL1361A0	D8-D10 J.G. STEAM SOLENOID VALVE	1	PZ				
Code	Description	Qty	UOM														
EL1361A0	D8-D10 J.G. STEAM SOLENOID VALVE	1	PZ														
TB2937A	D=10 EXTERNAL WATER PIPE + CONNECTION		TB2937A0	D=10 EXTERNAL WATER PIPE + CONNECTION													
VM2331A	FAN GUARD-TRAYS HOLDER PIN		KVM2331A	FAN GUARD-TRAYS HOLDER PIN KIT	<table border="1"> <thead> <tr> <th>Code</th> <th>Description</th> <th>Qty</th> <th>UOM</th> </tr> </thead> <tbody> <tr> <td>VM2331A0</td> <td>FAN GUARD-TRAY S HOLDER PIN</td> <td>4</td> <td>PZ</td> </tr> </tbody> </table>	Code	Description	Qty	UOM	VM2331A0	FAN GUARD-TRAY S HOLDER PIN	4	PZ				
Code	Description	Qty	UOM														
VM2331A0	FAN GUARD-TRAY S HOLDER PIN	4	PZ														

COMPONENT			SPARE PART																																																										
Code	Description	Image	Code	Description	Components list																																																								
0H2730A	ZINC PLATED MUFFLE SUPPORT BRACKET		0H2730A1	ZINC PLATED MUFFLE SUPPORT BRACKET																																																									
RC1378A	HOSE CLAMP		KVE1135A	SERIES 5/5E VENTURI KIT	<table border="1"> <thead> <tr> <th>Code</th> <th>Description</th> <th>Qty</th> <th>UOM</th> </tr> </thead> <tbody> <tr> <td>GN1556A0</td> <td>MM VENTURI SEAL</td> <td>1</td> <td>PZ</td> </tr> <tr> <td>RC1378A0</td> <td>HOSE CLAMP</td> <td>2</td> <td>PZ</td> </tr> <tr> <td>TB1520A0</td> <td>INT. Ø=38 TH=4 DRAIN BLACK RUBBER PIPE</td> <td>0.050</td> <td>M</td> </tr> <tr> <td>VE1135A0</td> <td>220 V 50/60 HZ VENTURI ACTUATOR</td> <td>1</td> <td>PZ</td> </tr> <tr> <td>VI1032A0</td> <td>SCREW M4X16 TCB+ INOX</td> <td>1</td> <td>PZ</td> </tr> <tr> <td>VI1511A0</td> <td>STAINLESS STEEL WASHER 4.2X12X1</td> <td>2</td> <td>PZ</td> </tr> <tr> <td>VI1850A0</td> <td>M4X6 NICKEL PLATED FIXING SCRE</td> <td>2</td> <td>PZ</td> </tr> <tr> <td>VI1865A0</td> <td>5X10 TCB+ SELF-THREADI NG SCREW</td> <td>3</td> <td>PZ</td> </tr> <tr> <td>VI1965A0</td> <td></td> <td>2</td> <td>PZ</td> </tr> <tr> <td>VM1565B0</td> <td>VENTURI LOWER COIL SUPPORT</td> <td>1</td> <td>PZ</td> </tr> <tr> <td>VM1566A0</td> <td>VENTURI UPPER COIL SUPPORT</td> <td>1</td> <td>PZ</td> </tr> <tr> <td>VM1567A0</td> <td>VENTURI LOWER BUSHING</td> <td>1</td> <td>PZ</td> </tr> <tr> <td>VM1568A0</td> <td>VENTURI PLATE SPACE</td> <td>1</td> <td>PZ</td> </tr> </tbody> </table>	Code	Description	Qty	UOM	GN1556A0	MM VENTURI SEAL	1	PZ	RC1378A0	HOSE CLAMP	2	PZ	TB1520A0	INT. Ø=38 TH=4 DRAIN BLACK RUBBER PIPE	0.050	M	VE1135A0	220 V 50/60 HZ VENTURI ACTUATOR	1	PZ	VI1032A0	SCREW M4X16 TCB+ INOX	1	PZ	VI1511A0	STAINLESS STEEL WASHER 4.2X12X1	2	PZ	VI1850A0	M4X6 NICKEL PLATED FIXING SCRE	2	PZ	VI1865A0	5X10 TCB+ SELF-THREADI NG SCREW	3	PZ	VI1965A0		2	PZ	VM1565B0	VENTURI LOWER COIL SUPPORT	1	PZ	VM1566A0	VENTURI UPPER COIL SUPPORT	1	PZ	VM1567A0	VENTURI LOWER BUSHING	1	PZ	VM1568A0	VENTURI PLATE SPACE	1	PZ
Code	Description	Qty	UOM																																																										
GN1556A0	MM VENTURI SEAL	1	PZ																																																										
RC1378A0	HOSE CLAMP	2	PZ																																																										
TB1520A0	INT. Ø=38 TH=4 DRAIN BLACK RUBBER PIPE	0.050	M																																																										
VE1135A0	220 V 50/60 HZ VENTURI ACTUATOR	1	PZ																																																										
VI1032A0	SCREW M4X16 TCB+ INOX	1	PZ																																																										
VI1511A0	STAINLESS STEEL WASHER 4.2X12X1	2	PZ																																																										
VI1850A0	M4X6 NICKEL PLATED FIXING SCRE	2	PZ																																																										
VI1865A0	5X10 TCB+ SELF-THREADI NG SCREW	3	PZ																																																										
VI1965A0		2	PZ																																																										
VM1565B0	VENTURI LOWER COIL SUPPORT	1	PZ																																																										
VM1566A0	VENTURI UPPER COIL SUPPORT	1	PZ																																																										
VM1567A0	VENTURI LOWER BUSHING	1	PZ																																																										
VM1568A0	VENTURI PLATE SPACE	1	PZ																																																										
VM2377A	220 V 50/60 HZ VENTURI KIT		KVM2377A	MM 220 V VENTURI ACTUATOR SYSTEM KIT	<table border="1"> <thead> <tr> <th>Code</th> <th>Description</th> <th>Qty</th> <th>UOM</th> </tr> </thead> <tbody> <tr> <td>GN1556A0</td> <td>MM VENTURI SEAL</td> <td>1</td> <td>PZ</td> </tr> <tr> <td>RC1378A0</td> <td>HOSE CLAMP</td> <td>3</td> <td>PZ</td> </tr> <tr> <td>TB1520A0</td> <td>INT. Ø=38 TH=4 DRAIN BLACK RUBBER PIPE</td> <td>0.170</td> <td>M</td> </tr> </tbody> </table>	Code	Description	Qty	UOM	GN1556A0	MM VENTURI SEAL	1	PZ	RC1378A0	HOSE CLAMP	3	PZ	TB1520A0	INT. Ø=38 TH=4 DRAIN BLACK RUBBER PIPE	0.170	M																																								
Code	Description	Qty	UOM																																																										
GN1556A0	MM VENTURI SEAL	1	PZ																																																										
RC1378A0	HOSE CLAMP	3	PZ																																																										
TB1520A0	INT. Ø=38 TH=4 DRAIN BLACK RUBBER PIPE	0.170	M																																																										

COMPONENT			SPARE PART																																																										
Code	Description	Image	Code	Description	Components list																																																								
VM2377A	220 V 50/60 HZ VENTURI KIT		KVM2377A	MM 220 V VENTURI ACTUATOR SYSTEM KIT	<table border="1"> <thead> <tr> <th>Code</th> <th>Description</th> <th>Qty</th> <th>UOM</th> </tr> </thead> <tbody> <tr> <td>VE1135A0</td> <td>220 V 50/60 HZ VENTURI ACTUATOR</td> <td>1</td> <td>PZ</td> </tr> <tr> <td>VI1032A0</td> <td>SCREW M4X16 TCB+ INOX</td> <td>1</td> <td>PZ</td> </tr> <tr> <td>VI1220A1</td> <td>4,2X12 TCB SELF-TAPPIN G SCREW</td> <td>6</td> <td>PZ</td> </tr> <tr> <td>VM2345A0</td> <td>MM VENTURI UPPER HALF</td> <td>1</td> <td>PZ</td> </tr> <tr> <td>VM2345A0</td> <td>MM VENTURI UPPER HALF</td> <td>1</td> <td>PZ</td> </tr> <tr> <td>VM2346A0</td> <td>MM VENTURI LOWER HALF</td> <td>1</td> <td>PZ</td> </tr> <tr> <td>VM2346A0</td> <td>MM VENTURI LOWER HALF</td> <td>1</td> <td>PZ</td> </tr> <tr> <td>VM2347A0</td> <td>MIND.MAPS VENTURI COVER</td> <td>1</td> <td>PZ</td> </tr> <tr> <td>VM2347A0</td> <td>MIND.MAPS VENTURI COVER</td> <td>1</td> <td>PZ</td> </tr> <tr> <td>VM2348A0</td> <td>VENTURI PLATE SPACE</td> <td>1</td> <td>PZ</td> </tr> <tr> <td>VM2348A0</td> <td>VENTURI PLATE SPACE</td> <td>1</td> <td>PZ</td> </tr> <tr> <td>VM2349A0</td> <td>VENTURI LOWER BUSHING</td> <td>1</td> <td>PZ</td> </tr> <tr> <td>VM2349A0</td> <td>VENTURI LOWER BUSHING</td> <td>1</td> <td>PZ</td> </tr> </tbody> </table>	Code	Description	Qty	UOM	VE1135A0	220 V 50/60 HZ VENTURI ACTUATOR	1	PZ	VI1032A0	SCREW M4X16 TCB+ INOX	1	PZ	VI1220A1	4,2X12 TCB SELF-TAPPIN G SCREW	6	PZ	VM2345A0	MM VENTURI UPPER HALF	1	PZ	VM2345A0	MM VENTURI UPPER HALF	1	PZ	VM2346A0	MM VENTURI LOWER HALF	1	PZ	VM2346A0	MM VENTURI LOWER HALF	1	PZ	VM2347A0	MIND.MAPS VENTURI COVER	1	PZ	VM2347A0	MIND.MAPS VENTURI COVER	1	PZ	VM2348A0	VENTURI PLATE SPACE	1	PZ	VM2348A0	VENTURI PLATE SPACE	1	PZ	VM2349A0	VENTURI LOWER BUSHING	1	PZ	VM2349A0	VENTURI LOWER BUSHING	1	PZ
Code	Description	Qty	UOM																																																										
VE1135A0	220 V 50/60 HZ VENTURI ACTUATOR	1	PZ																																																										
VI1032A0	SCREW M4X16 TCB+ INOX	1	PZ																																																										
VI1220A1	4,2X12 TCB SELF-TAPPIN G SCREW	6	PZ																																																										
VM2345A0	MM VENTURI UPPER HALF	1	PZ																																																										
VM2345A0	MM VENTURI UPPER HALF	1	PZ																																																										
VM2346A0	MM VENTURI LOWER HALF	1	PZ																																																										
VM2346A0	MM VENTURI LOWER HALF	1	PZ																																																										
VM2347A0	MIND.MAPS VENTURI COVER	1	PZ																																																										
VM2347A0	MIND.MAPS VENTURI COVER	1	PZ																																																										
VM2348A0	VENTURI PLATE SPACE	1	PZ																																																										
VM2348A0	VENTURI PLATE SPACE	1	PZ																																																										
VM2349A0	VENTURI LOWER BUSHING	1	PZ																																																										
VM2349A0	VENTURI LOWER BUSHING	1	PZ																																																										
GN1584A	CORNER FITTING D30-D16		KGN1584A	D30-D16 CORNER FITTING KIT	<table border="1"> <thead> <tr> <th>Code</th> <th>Description</th> <th>Qty</th> <th>UOM</th> </tr> </thead> <tbody> <tr> <td>GN1584A0</td> <td>CORNER FITTING D30-D16</td> <td>1</td> <td>PZ</td> </tr> </tbody> </table>	Code	Description	Qty	UOM	GN1584A0	CORNER FITTING D30-D16	1	PZ																																																
Code	Description	Qty	UOM																																																										
GN1584A0	CORNER FITTING D30-D16	1	PZ																																																										
TB1956A	TB1520A-GREY SILICONE PIPE L=0,04M		KTB1002A	BLACK TUBE KIT EPDM 60MT TB1520	<table border="1"> <thead> <tr> <th>Code</th> <th>Description</th> <th>Qty</th> <th>UOM</th> </tr> </thead> <tbody> <tr> <td>IL1206C0</td> <td>968X1053 H126 XBC WOOD PALLE</td> <td>1</td> <td>PZ</td> </tr> <tr> <td>TB1520A0</td> <td>INT. Ø=38 TH=4 DRAIN BLACK RUBBER PIPE</td> <td>60</td> <td>M</td> </tr> </tbody> </table>	Code	Description	Qty	UOM	IL1206C0	968X1053 H126 XBC WOOD PALLE	1	PZ	TB1520A0	INT. Ø=38 TH=4 DRAIN BLACK RUBBER PIPE	60	M																																												
Code	Description	Qty	UOM																																																										
IL1206C0	968X1053 H126 XBC WOOD PALLE	1	PZ																																																										
TB1520A0	INT. Ø=38 TH=4 DRAIN BLACK RUBBER PIPE	60	M																																																										

COMPONENT			SPARE PART																										
Code	Description	Image	Code	Description	Components list																								
TB1956A	TB1520A-GREY SILICONE PIPE L=0,04M		KTB1001A	BLACK TUBE KIT EPDM 10MT TB1520	<table border="1"> <thead> <tr> <th>Code</th> <th>Description</th> <th>Qty</th> <th>UOM</th> </tr> </thead> <tbody> <tr> <td>TB1520A0</td> <td>INT. Ø=38 TH=4 DRAIN BLACK RUBBER PIPE</td> <td>10</td> <td>M</td> </tr> <tr> <td>VM1794A0</td> <td>250X4.8 PA66 BLACK CLAMP</td> <td>3</td> <td>PZ</td> </tr> </tbody> </table>	Code	Description	Qty	UOM	TB1520A0	INT. Ø=38 TH=4 DRAIN BLACK RUBBER PIPE	10	M	VM1794A0	250X4.8 PA66 BLACK CLAMP	3	PZ												
			Code	Description	Qty	UOM																							
TB1520A0	INT. Ø=38 TH=4 DRAIN BLACK RUBBER PIPE	10	M																										
VM1794A0	250X4.8 PA66 BLACK CLAMP	3	PZ																										
KTB1000A	BLACK TUBE KIT EPDM 2MT TB1520A	<table border="1"> <thead> <tr> <th>Code</th> <th>Description</th> <th>Qty</th> <th>UOM</th> </tr> </thead> <tbody> <tr> <td>RC1055A0</td> <td>Ø25-40 H12 STAINLESS STEEL PIPE CLIP</td> <td>2</td> <td>PZ</td> </tr> <tr> <td>TB1520A0</td> <td>INT. Ø=38 TH=4 DRAIN BLACK RUBBER PIPE</td> <td>2</td> <td>M</td> </tr> <tr> <td>VM1059A1</td> <td>HEAT SHRINK FILM H800</td> <td>1.500</td> <td>M</td> </tr> </tbody> </table>	Code	Description	Qty	UOM	RC1055A0	Ø25-40 H12 STAINLESS STEEL PIPE CLIP	2	PZ	TB1520A0	INT. Ø=38 TH=4 DRAIN BLACK RUBBER PIPE	2	M	VM1059A1	HEAT SHRINK FILM H800	1.500	M											
Code	Description	Qty	UOM																										
RC1055A0	Ø25-40 H12 STAINLESS STEEL PIPE CLIP	2	PZ																										
TB1520A0	INT. Ø=38 TH=4 DRAIN BLACK RUBBER PIPE	2	M																										
VM1059A1	HEAT SHRINK FILM H800	1.500	M																										
RC1042A	DOUBLE WIRE SPRING CLAMP D21.5-22.6		RC1042A0	DOUBLE WIRE SPRING CLAMP D21.5-22.6																									
TB2957B	XEVC-0511-E VENTURI PIPE		KTB2957B	0511/04EU-E VENTURI COLLECTOR PIPE KI	<table border="1"> <thead> <tr> <th>Code</th> <th>Description</th> <th>Qty</th> <th>UOM</th> </tr> </thead> <tbody> <tr> <td>GN1544A0</td> <td>AIR INLET GASKET</td> <td>1</td> <td>PZ</td> </tr> <tr> <td>GN1584A0</td> <td>CORNER FITTING D30-D16</td> <td>1</td> <td>PZ</td> </tr> <tr> <td>RC1042A0</td> <td>DOUBLE WIRE SPRING CLAMP D21.5-22.6</td> <td>1</td> <td>PZ</td> </tr> <tr> <td>TB2957B0</td> <td>XEVC-0511-E VENTURI PIPE</td> <td>1</td> <td>PZ</td> </tr> <tr> <td>VM1794A0</td> <td>250X4.8 PA66 BLACK CLAMP</td> <td>1</td> <td>PZ</td> </tr> </tbody> </table>	Code	Description	Qty	UOM	GN1544A0	AIR INLET GASKET	1	PZ	GN1584A0	CORNER FITTING D30-D16	1	PZ	RC1042A0	DOUBLE WIRE SPRING CLAMP D21.5-22.6	1	PZ	TB2957B0	XEVC-0511-E VENTURI PIPE	1	PZ	VM1794A0	250X4.8 PA66 BLACK CLAMP	1	PZ
			Code	Description	Qty	UOM																							
			GN1544A0	AIR INLET GASKET	1	PZ																							
			GN1584A0	CORNER FITTING D30-D16	1	PZ																							
			RC1042A0	DOUBLE WIRE SPRING CLAMP D21.5-22.6	1	PZ																							
TB2957B0	XEVC-0511-E VENTURI PIPE	1	PZ																										
VM1794A0	250X4.8 PA66 BLACK CLAMP	1	PZ																										
GN1588A	78X28 G6.25 HEATING ELEMENT GASKET		GN1588A0	78X28 G6.25 HEATING ELEMENT GASKET																									

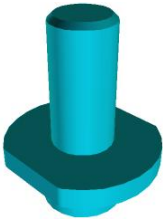

COMPONENT			SPARE PART		
Code	Description	Image	Code	Description	Components list
VM2416A	SMOKER BLOCKING GUIDE PIN		VM2416A0	SMOKER BLOCKING GUIDE PIN	



PLATON SERVICE

8 (800) 500-34-47

www.platonservice.com

ASM2916A/0.D00 - External cover

FRONT

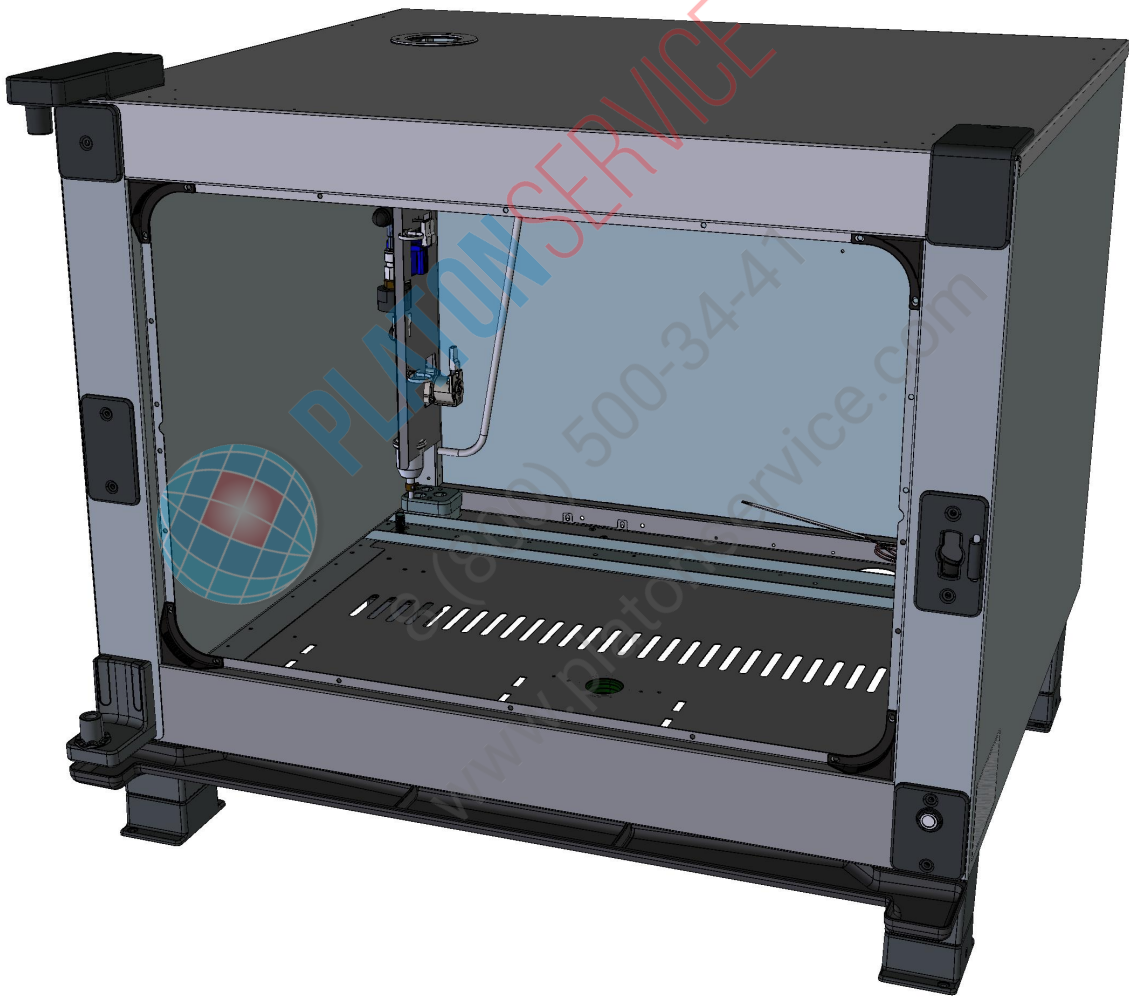

ASM2916A/0.D00 - External cover

REAR



COMPONENT			SPARE PART																										
Code	Description	Image	Code	Description	Components list																								
TR1136A	330°C 1 POLE SAFETY THERMOSTAT		KTR1136A	330°C SAFETY THERMOSTAT KIT	<table border="1"> <thead> <tr> <th>Code</th> <th>Description</th> <th>Qty</th> <th>UOM</th> </tr> </thead> <tbody> <tr> <td>0H7030A0</td> <td>THERMOSTAT BULB INLET COVER</td> <td>1</td> <td>PZ</td> </tr> <tr> <td>GN1531A0</td> <td>THERMOSTAT BULB INLET SEALING</td> <td>1</td> <td>PZ</td> </tr> <tr> <td>SL1045A0</td> <td>S57 BLACK SILICONE - 80ML CARTRIDGE</td> <td>1</td> <td>PZ</td> </tr> <tr> <td>TR1136A0</td> <td>330°C 1 POLE SAFETY THERMOSTAT</td> <td>1</td> <td>PZ</td> </tr> <tr> <td>VI1220A1</td> <td>4,2X12 TCB SELF-TAPPIN G SCREW</td> <td>3</td> <td>PZ</td> </tr> </tbody> </table>	Code	Description	Qty	UOM	0H7030A0	THERMOSTAT BULB INLET COVER	1	PZ	GN1531A0	THERMOSTAT BULB INLET SEALING	1	PZ	SL1045A0	S57 BLACK SILICONE - 80ML CARTRIDGE	1	PZ	TR1136A0	330°C 1 POLE SAFETY THERMOSTAT	1	PZ	VI1220A1	4,2X12 TCB SELF-TAPPIN G SCREW	3	PZ
Code	Description	Qty	UOM																										
0H7030A0	THERMOSTAT BULB INLET COVER	1	PZ																										
GN1531A0	THERMOSTAT BULB INLET SEALING	1	PZ																										
SL1045A0	S57 BLACK SILICONE - 80ML CARTRIDGE	1	PZ																										
TR1136A0	330°C 1 POLE SAFETY THERMOSTAT	1	PZ																										
VI1220A1	4,2X12 TCB SELF-TAPPIN G SCREW	3	PZ																										
VM1750A	BRASS COMB CLAM		KVM1750A	COMB TERMINAL BLOCK KIT	<table border="1"> <thead> <tr> <th>Code</th> <th>Description</th> <th>Qty</th> <th>UOM</th> </tr> </thead> <tbody> <tr> <td>VM1750A0</td> <td>BRASS COMB CLAMP</td> <td>1</td> <td>PZ</td> </tr> </tbody> </table>	Code	Description	Qty	UOM	VM1750A0	BRASS COMB CLAMP	1	PZ																
Code	Description	Qty	UOM																										
VM1750A0	BRASS COMB CLAMP	1	PZ																										
VM2074A	DRIP TRAY FIXING CLIP WITH SCREW		KVM1220A	CT/BT DRIP TRAY FIXING CLIPS 4PCS KIT	<table border="1"> <thead> <tr> <th>Code</th> <th>Description</th> <th>Qty</th> <th>UOM</th> </tr> </thead> <tbody> <tr> <td>VI1220A1</td> <td>4,2X12 TCB SELF-TAPPIN G SCREW</td> <td>4</td> <td>PZ</td> </tr> <tr> <td>VM1220A0</td> <td>CLIP TO FIX DRIP TRAY C.T</td> <td>4</td> <td>PZ</td> </tr> <tr> <td>VM2074A0</td> <td>DRIP TRAY C.T FIXING CLIP WITH SCREW</td> <td>4</td> <td>PZ</td> </tr> </tbody> </table>	Code	Description	Qty	UOM	VI1220A1	4,2X12 TCB SELF-TAPPIN G SCREW	4	PZ	VM1220A0	CLIP TO FIX DRIP TRAY C.T	4	PZ	VM2074A0	DRIP TRAY C.T FIXING CLIP WITH SCREW	4	PZ								
Code	Description	Qty	UOM																										
VI1220A1	4,2X12 TCB SELF-TAPPIN G SCREW	4	PZ																										
VM1220A0	CLIP TO FIX DRIP TRAY C.T	4	PZ																										
VM2074A0	DRIP TRAY C.T FIXING CLIP WITH SCREW	4	PZ																										
VN1165A	230VAC 50/60HZ COOLING DOWN FA		KVN1165A	S.5E ADVANCE/MM 230V COOLING FAN KIT	<table border="1"> <thead> <tr> <th>Code</th> <th>Description</th> <th>Qty</th> <th>UOM</th> </tr> </thead> <tbody> <tr> <td>VI1099A0</td> <td>SELF-DRILLIN G SCREW 4.8X13 TCB+ Z</td> <td>4</td> <td>PZ</td> </tr> <tr> <td>VM1555A2</td> <td>CT BT COOLING FAN SUPPORT</td> <td>1</td> <td>PZ</td> </tr> <tr> <td>VN1165A0</td> <td>230VAC 50/60HZ COOLING DOWN FAN</td> <td>1</td> <td>PZ</td> </tr> <tr> <td>VN1165A0</td> <td>230VAC 50/60HZ COOLING DOWN FAN</td> <td>1</td> <td>PZ</td> </tr> </tbody> </table>	Code	Description	Qty	UOM	VI1099A0	SELF-DRILLIN G SCREW 4.8X13 TCB+ Z	4	PZ	VM1555A2	CT BT COOLING FAN SUPPORT	1	PZ	VN1165A0	230VAC 50/60HZ COOLING DOWN FAN	1	PZ	VN1165A0	230VAC 50/60HZ COOLING DOWN FAN	1	PZ				
Code	Description	Qty	UOM																										
VI1099A0	SELF-DRILLIN G SCREW 4.8X13 TCB+ Z	4	PZ																										
VM1555A2	CT BT COOLING FAN SUPPORT	1	PZ																										
VN1165A0	230VAC 50/60HZ COOLING DOWN FAN	1	PZ																										
VN1165A0	230VAC 50/60HZ COOLING DOWN FAN	1	PZ																										





COMPONENT			SPARE PART																						
Code	Description	Image	Code	Description	Components list																				
VM1556A	XBC-XVC COOLING FAN GUARD		KVM1556A	XBC-XVC COOLING FAN GUARD KIT	<table border="1"> <thead> <tr> <th>Code</th> <th>Description</th> <th>Qty</th> <th>UOM</th> </tr> </thead> <tbody> <tr> <td>VM1556A0</td> <td>XBC-XVC COOLING FAN GUARD</td> <td>1</td> <td>PZ</td> </tr> </tbody> </table>	Code	Description	Qty	UOM	VM1556A0	XBC-XVC COOLING FAN GUARD	1	PZ												
Code	Description	Qty	UOM																						
VM1556A0	XBC-XVC COOLING FAN GUARD	1	PZ																						
VM1555A	CT BT COOLING FAN SUPPORT		KVN1165A	S.5E ADVANCE/MM 230V COOLING FAN KIT	<table border="1"> <thead> <tr> <th>Code</th> <th>Description</th> <th>Qty</th> <th>UOM</th> </tr> </thead> <tbody> <tr> <td>VI1099A0</td> <td>SELF-DRILLIN G SCREW 4.8X13 TCB+ Z</td> <td>4</td> <td>PZ</td> </tr> <tr> <td>VM1555A2</td> <td>CT BT COOLING FAN SUPPORT</td> <td>1</td> <td>PZ</td> </tr> <tr> <td>VN1165A0</td> <td>230VAC 50/60HZ COOLING DOWN FAN</td> <td>1</td> <td>PZ</td> </tr> <tr> <td>VN1165A0</td> <td>230VAC 50/60HZ COOLING DOWN FAN</td> <td>1</td> <td>PZ</td> </tr> </tbody> </table>	Code	Description	Qty	UOM	VI1099A0	SELF-DRILLIN G SCREW 4.8X13 TCB+ Z	4	PZ	VM1555A2	CT BT COOLING FAN SUPPORT	1	PZ	VN1165A0	230VAC 50/60HZ COOLING DOWN FAN	1	PZ	VN1165A0	230VAC 50/60HZ COOLING DOWN FAN	1	PZ
Code	Description	Qty	UOM																						
VI1099A0	SELF-DRILLIN G SCREW 4.8X13 TCB+ Z	4	PZ																						
VM1555A2	CT BT COOLING FAN SUPPORT	1	PZ																						
VN1165A0	230VAC 50/60HZ COOLING DOWN FAN	1	PZ																						
VN1165A0	230VAC 50/60HZ COOLING DOWN FAN	1	PZ																						
			KVN1164A	S.5/5E 12VDC COOLING DOWN FAN KIT	<table border="1"> <thead> <tr> <th>Code</th> <th>Description</th> <th>Qty</th> <th>UOM</th> </tr> </thead> <tbody> <tr> <td>VI1099A0</td> <td>SELF-DRILLIN G SCREW 4.8X13 TCB+ Z</td> <td>4</td> <td>PZ</td> </tr> <tr> <td>VM1555A2</td> <td>CT BT COOLING FAN SUPPORT</td> <td>1</td> <td>PZ</td> </tr> <tr> <td>VN1164A0</td> <td>12VDC COOLING DONW FAN</td> <td>1</td> <td>PZ</td> </tr> <tr> <td>VN1164A0</td> <td>12VDC COOLING DONW FAN</td> <td>1</td> <td>PZ</td> </tr> </tbody> </table>	Code	Description	Qty	UOM	VI1099A0	SELF-DRILLIN G SCREW 4.8X13 TCB+ Z	4	PZ	VM1555A2	CT BT COOLING FAN SUPPORT	1	PZ	VN1164A0	12VDC COOLING DONW FAN	1	PZ	VN1164A0	12VDC COOLING DONW FAN	1	PZ
Code	Description	Qty	UOM																						
VI1099A0	SELF-DRILLIN G SCREW 4.8X13 TCB+ Z	4	PZ																						
VM1555A2	CT BT COOLING FAN SUPPORT	1	PZ																						
VN1164A0	12VDC COOLING DONW FAN	1	PZ																						
VN1164A0	12VDC COOLING DONW FAN	1	PZ																						
0H1019A	BRACKET FOR CHEFTOP H100 FEE		0H1019A2	BRACKET FOR CHEFTOP H100 FEE																					

COMPONENT			SPARE PART																						
Code	Description	Image	Code	Description	Components list																				
PD1074A	H=100 SQUARE FOO		KPD1074A	MIND.MAPS H100 FOOT KIT	<table border="1"> <thead> <tr> <th>Code</th> <th>Description</th> <th>Qty</th> <th>UOM</th> </tr> </thead> <tbody> <tr> <td>PD1074A0</td> <td>H=100 SQUARE FOO</td> <td>1</td> <td>PZ</td> </tr> <tr> <td>PD1075A0</td> <td>FOOT LOCKING BRACKET</td> <td>1</td> <td>PZ</td> </tr> <tr> <td>PD1075A1</td> <td>PD1074 FOOT LOCKING BRACKET</td> <td>1</td> <td>PZ</td> </tr> <tr> <td>VI1220A1</td> <td>4,2X12 TCB SELF-TAPPIN G SCREW</td> <td>5</td> <td>PZ</td> </tr> </tbody> </table>	Code	Description	Qty	UOM	PD1074A0	H=100 SQUARE FOO	1	PZ	PD1075A0	FOOT LOCKING BRACKET	1	PZ	PD1075A1	PD1074 FOOT LOCKING BRACKET	1	PZ	VI1220A1	4,2X12 TCB SELF-TAPPIN G SCREW	5	PZ
Code	Description	Qty	UOM																						
PD1074A0	H=100 SQUARE FOO	1	PZ																						
PD1075A0	FOOT LOCKING BRACKET	1	PZ																						
PD1075A1	PD1074 FOOT LOCKING BRACKET	1	PZ																						
VI1220A1	4,2X12 TCB SELF-TAPPIN G SCREW	5	PZ																						
PD1075A	FOOT LOCKING BRACKET		KPD1075A	OVEN FOOT STOPPING BRACKET KIT	<table border="1"> <thead> <tr> <th>Code</th> <th>Description</th> <th>Qty</th> <th>UOM</th> </tr> </thead> <tbody> <tr> <td>PD1075A0</td> <td>FOOT LOCKING BRACKET</td> <td>4</td> <td>PZ</td> </tr> <tr> <td>PD1075A1</td> <td>PD1074 FOOT LOCKING BRACKET</td> <td>4</td> <td>PZ</td> </tr> <tr> <td>VI1950A0</td> <td>ST. STEEL 4,2X13 TCB SELF-DRILLIN G SCREW</td> <td>8</td> <td>PZ</td> </tr> </tbody> </table>	Code	Description	Qty	UOM	PD1075A0	FOOT LOCKING BRACKET	4	PZ	PD1075A1	PD1074 FOOT LOCKING BRACKET	4	PZ	VI1950A0	ST. STEEL 4,2X13 TCB SELF-DRILLIN G SCREW	8	PZ				
Code	Description	Qty	UOM																						
PD1075A0	FOOT LOCKING BRACKET	4	PZ																						
PD1075A1	PD1074 FOOT LOCKING BRACKET	4	PZ																						
VI1950A0	ST. STEEL 4,2X13 TCB SELF-DRILLIN G SCREW	8	PZ																						
VL1026A	BEND FOR DRAIN PIPE		KVL1026A	DRAIN PIPE BEND KI	<table border="1"> <thead> <tr> <th>Code</th> <th>Description</th> <th>Qty</th> <th>UOM</th> </tr> </thead> <tbody> <tr> <td>GN1400A0</td> <td>U-TRAP SEAL</td> <td>1</td> <td>PZ</td> </tr> <tr> <td>VL1026A0</td> <td>BEND FOR DRAIN PIPE</td> <td>1</td> <td>PZ</td> </tr> <tr> <td>VM2039A0</td> <td>DRAIN BEND FIXING RING</td> <td>1</td> <td>PZ</td> </tr> </tbody> </table>	Code	Description	Qty	UOM	GN1400A0	U-TRAP SEAL	1	PZ	VL1026A0	BEND FOR DRAIN PIPE	1	PZ	VM2039A0	DRAIN BEND FIXING RING	1	PZ				
Code	Description	Qty	UOM																						
GN1400A0	U-TRAP SEAL	1	PZ																						
VL1026A0	BEND FOR DRAIN PIPE	1	PZ																						
VM2039A0	DRAIN BEND FIXING RING	1	PZ																						
VM2039A	DRAIN BEND FIXING RING		KVL1026A	DRAIN PIPE BEND KI	<table border="1"> <thead> <tr> <th>Code</th> <th>Description</th> <th>Qty</th> <th>UOM</th> </tr> </thead> <tbody> <tr> <td>GN1400A0</td> <td>U-TRAP SEAL</td> <td>1</td> <td>PZ</td> </tr> <tr> <td>VL1026A0</td> <td>BEND FOR DRAIN PIPE</td> <td>1</td> <td>PZ</td> </tr> <tr> <td>VM2039A0</td> <td>DRAIN BEND FIXING RING</td> <td>1</td> <td>PZ</td> </tr> </tbody> </table>	Code	Description	Qty	UOM	GN1400A0	U-TRAP SEAL	1	PZ	VL1026A0	BEND FOR DRAIN PIPE	1	PZ	VM2039A0	DRAIN BEND FIXING RING	1	PZ				
Code	Description	Qty	UOM																						
GN1400A0	U-TRAP SEAL	1	PZ																						
VL1026A0	BEND FOR DRAIN PIPE	1	PZ																						
VM2039A0	DRAIN BEND FIXING RING	1	PZ																						
VM2249A	COOKING CHAMBER FRONT CORNER		KVM2249A	CHAMBER FRONT PROFILE CORNER KIT	<table border="1"> <thead> <tr> <th>Code</th> <th>Description</th> <th>Qty</th> <th>UOM</th> </tr> </thead> <tbody> <tr> <td>VM2249A0</td> <td>COOKING CHAMBER FRONT CORNER</td> <td>1</td> <td>PZ</td> </tr> </tbody> </table>	Code	Description	Qty	UOM	VM2249A0	COOKING CHAMBER FRONT CORNER	1	PZ												
Code	Description	Qty	UOM																						
VM2249A0	COOKING CHAMBER FRONT CORNER	1	PZ																						







COMPONENT			SPARE PART										
Code	Description	Image	Code	Description	Components list								
0H2561A	6 S. DOOR COUNTERBRACKET		0H2561A0	6 S. DOOR COUNTERBRACKET									
VM1240A	NYLON SUPPORT CAP		KVM1240A	4 PCS COUNTER BRACKET SUPPORT CAP KIT	<table border="1"> <thead> <tr> <th>Code</th> <th>Description</th> <th>Qty</th> <th>UOM</th> </tr> </thead> <tbody> <tr> <td>VM1240A0</td> <td>NYLON SUPPORT CAP</td> <td>4</td> <td>PZ</td> </tr> </tbody> </table>	Code	Description	Qty	UOM	VM1240A0	NYLON SUPPORT CAP	4	PZ
Code	Description	Qty	UOM										
VM1240A0	NYLON SUPPORT CAP	4	PZ										
VM2310A	UPPER DOOR BRACKET HOLES COVER		KVM2310A	UPPER BRACKET HOLE COVER KIT	<table border="1"> <thead> <tr> <th>Code</th> <th>Description</th> <th>Qty</th> <th>UOM</th> </tr> </thead> <tbody> <tr> <td>VM2310A0</td> <td>UPPER DOOR BRACKET HOLES COVER</td> <td>1</td> <td>PZ</td> </tr> </tbody> </table>	Code	Description	Qty	UOM	VM2310A0	UPPER DOOR BRACKET HOLES COVER	1	PZ
Code	Description	Qty	UOM										
VM2310A0	UPPER DOOR BRACKET HOLES COVER	1	PZ										
VM2306A	PIPE STOP PASSIN		KVM2306A	PASSAGE LOCK PIPES CLAMP KIT	<table border="1"> <thead> <tr> <th>Code</th> <th>Description</th> <th>Qty</th> <th>UOM</th> </tr> </thead> <tbody> <tr> <td>VM2306A0</td> <td>PIPE STOP PASSING</td> <td>1</td> <td>PZ</td> </tr> </tbody> </table>	Code	Description	Qty	UOM	VM2306A0	PIPE STOP PASSING	1	PZ
Code	Description	Qty	UOM										
VM2306A0	PIPE STOP PASSING	1	PZ										
VM2307A	PIPE STOP LOCKING COVER		KVM2307A	CLAMPING LOCK PIPES COVER KIT	<table border="1"> <thead> <tr> <th>Code</th> <th>Description</th> <th>Qty</th> <th>UOM</th> </tr> </thead> <tbody> <tr> <td>VM2307A0</td> <td>PIPE STOP LOCKING COVER</td> <td>1</td> <td>PZ</td> </tr> </tbody> </table>	Code	Description	Qty	UOM	VM2307A0	PIPE STOP LOCKING COVER	1	PZ
Code	Description	Qty	UOM										
VM2307A0	PIPE STOP LOCKING COVER	1	PZ										

COMPONENT			SPARE PART																										
Code	Description	Image	Code	Description	Components list																								
RC1006A	D8 PET PIPE GUIDE BEND		KRC1006A	20 PCS. Ø8 PET PIPE GUIDE BEND KI	<table border="1"> <thead> <tr> <th>Code</th> <th>Description</th> <th>Qty</th> <th>UOM</th> </tr> </thead> <tbody> <tr> <td>RC1006A0</td> <td>D8 PET PIPE GUIDE BEND</td> <td>20</td> <td>PZ</td> </tr> </tbody> </table>	Code	Description	Qty	UOM	RC1006A0	D8 PET PIPE GUIDE BEND	20	PZ																
Code	Description	Qty	UOM																										
RC1006A0	D8 PET PIPE GUIDE BEND	20	PZ																										
VM2061A	ACCESSORIES CABLES WALL PASSING		KVM1505A	THROUGH-WALL CONNECTION+DIAPHRAGM KIT	<table border="1"> <thead> <tr> <th>Code</th> <th>Description</th> <th>Qty</th> <th>UOM</th> </tr> </thead> <tbody> <tr> <td>VI1220A1</td> <td>4,2X12 TCB SELF-TAPPING SCREW</td> <td>1</td> <td>PZ</td> </tr> <tr> <td>VM1505A0</td> <td>WALL PASSING WITH DIAPHRAGM</td> <td>3</td> <td>PZ</td> </tr> <tr> <td>VM2055A0</td> <td>UPPER THROUGH-WALL CONNECTION</td> <td>1</td> <td>PZ</td> </tr> <tr> <td>VM2056A0</td> <td>LOWER THROUGH-WALL CONNECTION</td> <td>1</td> <td>PZ</td> </tr> </tbody> </table>	Code	Description	Qty	UOM	VI1220A1	4,2X12 TCB SELF-TAPPING SCREW	1	PZ	VM1505A0	WALL PASSING WITH DIAPHRAGM	3	PZ	VM2055A0	UPPER THROUGH-WALL CONNECTION	1	PZ	VM2056A0	LOWER THROUGH-WALL CONNECTION	1	PZ				
Code	Description	Qty	UOM																										
VI1220A1	4,2X12 TCB SELF-TAPPING SCREW	1	PZ																										
VM1505A0	WALL PASSING WITH DIAPHRAGM	3	PZ																										
VM2055A0	UPPER THROUGH-WALL CONNECTION	1	PZ																										
VM2056A0	LOWER THROUGH-WALL CONNECTION	1	PZ																										
VM1991A	CHEFTOP E SERIES DRIP TRAY		KVM1991A	E SERIES CHEFTOP DRIP TRAY	<table border="1"> <thead> <tr> <th>Code</th> <th>Description</th> <th>Qty</th> <th>UOM</th> </tr> </thead> <tbody> <tr> <td>VM1220A0</td> <td>CLIP TO FIX DRIP TRAY C.T</td> <td>4</td> <td>PZ</td> </tr> <tr> <td>VM1794A0</td> <td>250X4.8 PA66 BLACK CLAMP</td> <td>2</td> <td>PZ</td> </tr> <tr> <td>VM1991A0</td> <td>CHEFTOP E SERIES DRIP TRAY</td> <td>1</td> <td>PZ</td> </tr> <tr> <td>VM2074A0</td> <td>DRIP TRAY FIXING CLIP WITH SCREW</td> <td>4</td> <td>PZ</td> </tr> <tr> <td>VM2103A0</td> <td>CLAMP LOCK</td> <td>2</td> <td>PZ</td> </tr> </tbody> </table>	Code	Description	Qty	UOM	VM1220A0	CLIP TO FIX DRIP TRAY C.T	4	PZ	VM1794A0	250X4.8 PA66 BLACK CLAMP	2	PZ	VM1991A0	CHEFTOP E SERIES DRIP TRAY	1	PZ	VM2074A0	DRIP TRAY FIXING CLIP WITH SCREW	4	PZ	VM2103A0	CLAMP LOCK	2	PZ
Code	Description	Qty	UOM																										
VM1220A0	CLIP TO FIX DRIP TRAY C.T	4	PZ																										
VM1794A0	250X4.8 PA66 BLACK CLAMP	2	PZ																										
VM1991A0	CHEFTOP E SERIES DRIP TRAY	1	PZ																										
VM2074A0	DRIP TRAY FIXING CLIP WITH SCREW	4	PZ																										
VM2103A0	CLAMP LOCK	2	PZ																										
VM2035A	DRAIN PIPE SUPPORT		KVM2035A	DRAIN PIPE SUPPORT 2 PCS. KI	<table border="1"> <thead> <tr> <th>Code</th> <th>Description</th> <th>Qty</th> <th>UOM</th> </tr> </thead> <tbody> <tr> <td>VM2035A0</td> <td>DRAIN PIPE SUPPORT</td> <td>2</td> <td>PZ</td> </tr> </tbody> </table>	Code	Description	Qty	UOM	VM2035A0	DRAIN PIPE SUPPORT	2	PZ																
Code	Description	Qty	UOM																										
VM2035A0	DRAIN PIPE SUPPORT	2	PZ																										





COMPONENT			SPARE PART														
Code	Description	Image	Code	Description	Components list												
VM1810A	WATER RIGHT SEALING CAP		VM1810A0	WATER RIGHT SEALING CAP													
VM1811A	WATER LEFT SEALING CAP		VM1811A0	WATER LEFT SEALING CAP													
VM2311A	SCREWS COVER		KVM2311A	SCREWS COVER PLATE KIT	<table border="1"> <thead> <tr> <th>Code</th> <th>Description</th> <th>Qty</th> <th>UOM</th> </tr> </thead> <tbody> <tr> <td>VM2311A0</td> <td>SCREWS COVER</td> <td>1</td> <td>PZ</td> </tr> </tbody> </table>	Code	Description	Qty	UOM	VM2311A0	SCREWS COVER	1	PZ				
Code	Description	Qty	UOM														
VM2311A0	SCREWS COVER	1	PZ														
GN1558A	EXHAUST SEAL		K0H7291A	GASKET AND SEALING DISC CHIMNEY KIT	<table border="1"> <thead> <tr> <th>Code</th> <th>Description</th> <th>Qty</th> <th>UOM</th> </tr> </thead> <tbody> <tr> <td>0H7291A0</td> <td>CHIMNEY HOLDING DIS</td> <td>1</td> <td>PZ</td> </tr> <tr> <td>GN1558A0</td> <td>EXHAUST SEA</td> <td>1</td> <td>PZ</td> </tr> </tbody> </table>	Code	Description	Qty	UOM	0H7291A0	CHIMNEY HOLDING DIS	1	PZ	GN1558A0	EXHAUST SEA	1	PZ
Code	Description	Qty	UOM														
0H7291A0	CHIMNEY HOLDING DIS	1	PZ														
GN1558A0	EXHAUST SEA	1	PZ														
0H7291A	CHIMNEY HOLDING DISC		K0H7291A	GASKET AND SEALING DISC CHIMNEY KIT	<table border="1"> <thead> <tr> <th>Code</th> <th>Description</th> <th>Qty</th> <th>UOM</th> </tr> </thead> <tbody> <tr> <td>0H7291A0</td> <td>CHIMNEY HOLDING DIS</td> <td>1</td> <td>PZ</td> </tr> <tr> <td>GN1558A0</td> <td>EXHAUST SEA</td> <td>1</td> <td>PZ</td> </tr> </tbody> </table>	Code	Description	Qty	UOM	0H7291A0	CHIMNEY HOLDING DIS	1	PZ	GN1558A0	EXHAUST SEA	1	PZ
Code	Description	Qty	UOM														
0H7291A0	CHIMNEY HOLDING DIS	1	PZ														
GN1558A0	EXHAUST SEA	1	PZ														



COMPONENT			SPARE PART																																		
Code	Description	Image	Code	Description	Components list																																
0H2561A	6 S. DOOR COUNTERBRACKET		0H2561A0	6 S. DOOR COUNTERBRACKET																																	
VM1240A	NYLON SUPPORT CAP		KVM1240A	4 PCS COUNTER BRACKET SUPPORT CAP KIT	<table border="1"> <thead> <tr> <th>Code</th> <th>Description</th> <th>Qty</th> <th>UOM</th> </tr> </thead> <tbody> <tr> <td>VM1240A0</td> <td>NYLON SUPPORT CAP</td> <td>4</td> <td>PZ</td> </tr> </tbody> </table>	Code	Description	Qty	UOM	VM1240A0	NYLON SUPPORT CAP	4	PZ																								
Code	Description	Qty	UOM																																		
VM1240A0	NYLON SUPPORT CAP	4	PZ																																		
VM2282A	MICROSWITCH SUPPORT COVER		KVM2282A	MICROSWITCH SUPPORT PLATE KI	<table border="1"> <thead> <tr> <th>Code</th> <th>Description</th> <th>Qty</th> <th>UOM</th> </tr> </thead> <tbody> <tr> <td>VM2282A0</td> <td>MICROSWITC H SUPPORT COVER</td> <td>1</td> <td>PZ</td> </tr> </tbody> </table>	Code	Description	Qty	UOM	VM2282A0	MICROSWITC H SUPPORT COVER	1	PZ																								
Code	Description	Qty	UOM																																		
VM2282A0	MICROSWITC H SUPPORT COVER	1	PZ																																		
VE1020B	MAGNET DOOR MICROSWITCH		KVE1020B	MICROSWITCH KIT	<table border="1"> <thead> <tr> <th>Code</th> <th>Description</th> <th>Qty</th> <th>UOM</th> </tr> </thead> <tbody> <tr> <td>CE1030A0</td> <td>FEMALE FASTON COVER 6.3X0.8 0.5-1MMQ</td> <td>2</td> <td>PZ</td> </tr> <tr> <td>CE1660A0</td> <td>6,3X0,8 FEMALE FASTON COVE</td> <td>2</td> <td>PZ</td> </tr> <tr> <td>CE1730A0</td> <td>PVC CABLE NP 2 X AWG22 STYLE 2095</td> <td>0.150</td> <td>M</td> </tr> <tr> <td>CE1740A0</td> <td>MINIFIT MALE END FITTING</td> <td>2</td> <td>PZ</td> </tr> <tr> <td>CE1745A0</td> <td>2 WAYS FEMALE MINIFIT CONNECTOR</td> <td>1</td> <td>PZ</td> </tr> <tr> <td>VE1020B0</td> <td>MAGNET DOOR MICROSWITC</td> <td>1</td> <td>PZ</td> </tr> <tr> <td>VE1030A1</td> <td>MAGNET FOR DOOR MICROSWITC H D=22,9MM</td> <td>1</td> <td>PZ</td> </tr> </tbody> </table>	Code	Description	Qty	UOM	CE1030A0	FEMALE FASTON COVER 6.3X0.8 0.5-1MMQ	2	PZ	CE1660A0	6,3X0,8 FEMALE FASTON COVE	2	PZ	CE1730A0	PVC CABLE NP 2 X AWG22 STYLE 2095	0.150	M	CE1740A0	MINIFIT MALE END FITTING	2	PZ	CE1745A0	2 WAYS FEMALE MINIFIT CONNECTOR	1	PZ	VE1020B0	MAGNET DOOR MICROSWITC	1	PZ	VE1030A1	MAGNET FOR DOOR MICROSWITC H D=22,9MM	1	PZ
Code	Description	Qty	UOM																																		
CE1030A0	FEMALE FASTON COVER 6.3X0.8 0.5-1MMQ	2	PZ																																		
CE1660A0	6,3X0,8 FEMALE FASTON COVE	2	PZ																																		
CE1730A0	PVC CABLE NP 2 X AWG22 STYLE 2095	0.150	M																																		
CE1740A0	MINIFIT MALE END FITTING	2	PZ																																		
CE1745A0	2 WAYS FEMALE MINIFIT CONNECTOR	1	PZ																																		
VE1020B0	MAGNET DOOR MICROSWITC	1	PZ																																		
VE1030A1	MAGNET FOR DOOR MICROSWITC H D=22,9MM	1	PZ																																		

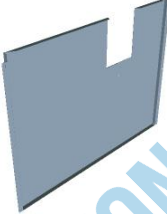

COMPONENT			SPARE PART																										
Code	Description	Image	Code	Description	Components list																								
0D2295A	GN1-1 XEVC EXTERNAL COVER		0D2295A0	GN1-1 XEVC EXTERNAL COVER																									
0F1496A	XEVC-0511-E BACK		0F1496A0	XEVC-0511-E BACK																									
VM1190A	CT BT RIGHT DOOR SPRING LATCH		KVM1190A	CHEFTOP/BAKERTO P DOOR RIGHT LATCH KIT	<table border="1"> <thead> <tr> <th>Code</th> <th>Description</th> <th>Qty</th> <th>UOM</th> </tr> </thead> <tbody> <tr> <td>VI0239A1</td> <td>SELF-TAPPIN G SCREW 4.2X25 TCB+ INOX</td> <td>2</td> <td>PZ</td> </tr> <tr> <td>VI1220A1</td> <td>4,2X12 TCB SELF-TAPPIN G SCREW</td> <td>2</td> <td>PZ</td> </tr> <tr> <td>VM1190A2</td> <td>CT BT RIGHT DOOR SPRING LATCH</td> <td>1</td> <td>PZ</td> </tr> <tr> <td>VM1192A1</td> <td>CT BT DOOR SPRING LATCH BACK COVER</td> <td>1</td> <td>PZ</td> </tr> <tr> <td>VM1460A0</td> <td>XBC/XVC RIGHT DOOR LATCH CAP</td> <td>1</td> <td>PZ</td> </tr> </tbody> </table>	Code	Description	Qty	UOM	VI0239A1	SELF-TAPPIN G SCREW 4.2X25 TCB+ INOX	2	PZ	VI1220A1	4,2X12 TCB SELF-TAPPIN G SCREW	2	PZ	VM1190A2	CT BT RIGHT DOOR SPRING LATCH	1	PZ	VM1192A1	CT BT DOOR SPRING LATCH BACK COVER	1	PZ	VM1460A0	XBC/XVC RIGHT DOOR LATCH CAP	1	PZ
Code	Description	Qty	UOM																										
VI0239A1	SELF-TAPPIN G SCREW 4.2X25 TCB+ INOX	2	PZ																										
VI1220A1	4,2X12 TCB SELF-TAPPIN G SCREW	2	PZ																										
VM1190A2	CT BT RIGHT DOOR SPRING LATCH	1	PZ																										
VM1192A1	CT BT DOOR SPRING LATCH BACK COVER	1	PZ																										
VM1460A0	XBC/XVC RIGHT DOOR LATCH CAP	1	PZ																										
VM2280A	DOOR LATCH COVE		KVM2280A	VM2280A HANDLE LATCH PLATE COVER KIT	<table border="1"> <thead> <tr> <th>Code</th> <th>Description</th> <th>Qty</th> <th>UOM</th> </tr> </thead> <tbody> <tr> <td>VI1074A0</td> <td></td> <td>2</td> <td>PZ</td> </tr> <tr> <td>VM1630A0</td> <td>INTERNAL GLASS PUSHING CAP</td> <td>1</td> <td>PZ</td> </tr> <tr> <td>VM2280A0</td> <td>DOOR LATCH COVER</td> <td>1</td> <td>PZ</td> </tr> <tr> <td>VM2280A1</td> <td>DOOR LATCH COVER</td> <td>1</td> <td>PZ</td> </tr> </tbody> </table>	Code	Description	Qty	UOM	VI1074A0		2	PZ	VM1630A0	INTERNAL GLASS PUSHING CAP	1	PZ	VM2280A0	DOOR LATCH COVER	1	PZ	VM2280A1	DOOR LATCH COVER	1	PZ				
Code	Description	Qty	UOM																										
VI1074A0		2	PZ																										
VM1630A0	INTERNAL GLASS PUSHING CAP	1	PZ																										
VM2280A0	DOOR LATCH COVER	1	PZ																										
VM2280A1	DOOR LATCH COVER	1	PZ																										

COMPONENT			SPARE PART																										
Code	Description	Image	Code	Description	Components list																								
VM1192A	CT BT DOOR SPRING LATCH BACK COVER		KVM1191A	CHEFTOP/BAKERTO P DOOR LEFT LATCH KIT	<table border="1"> <thead> <tr> <th>Code</th> <th>Description</th> <th>Qty</th> <th>UOM</th> </tr> </thead> <tbody> <tr> <td>VI0239A1</td> <td>SELF-TAPPIN G SCREW 4.2X25 TCB+ INOX</td> <td>2</td> <td>PZ</td> </tr> <tr> <td>VI1220A1</td> <td>4,2X12 TCB SELF-TAPPIN G SCREW</td> <td>2</td> <td>PZ</td> </tr> <tr> <td>VM1191A2</td> <td>CT BT LEFT DOOR SPRING LATCH</td> <td>1</td> <td>PZ</td> </tr> <tr> <td>VM1192A1</td> <td>CT BT DOOR SPRING LATCH BACK COVER</td> <td>1</td> <td>PZ</td> </tr> <tr> <td>VM1460A0</td> <td>XBC/XVC RIGHT DOOR LATCH CAP</td> <td>1</td> <td>PZ</td> </tr> </tbody> </table>	Code	Description	Qty	UOM	VI0239A1	SELF-TAPPIN G SCREW 4.2X25 TCB+ INOX	2	PZ	VI1220A1	4,2X12 TCB SELF-TAPPIN G SCREW	2	PZ	VM1191A2	CT BT LEFT DOOR SPRING LATCH	1	PZ	VM1192A1	CT BT DOOR SPRING LATCH BACK COVER	1	PZ	VM1460A0	XBC/XVC RIGHT DOOR LATCH CAP	1	PZ
			Code	Description	Qty	UOM																							
VI0239A1	SELF-TAPPIN G SCREW 4.2X25 TCB+ INOX	2	PZ																										
VI1220A1	4,2X12 TCB SELF-TAPPIN G SCREW	2	PZ																										
VM1191A2	CT BT LEFT DOOR SPRING LATCH	1	PZ																										
VM1192A1	CT BT DOOR SPRING LATCH BACK COVER	1	PZ																										
VM1460A0	XBC/XVC RIGHT DOOR LATCH CAP	1	PZ																										
KVM1190A	CHEFTOP/BAKERTO P DOOR RIGHT LATCH KIT	<table border="1"> <thead> <tr> <th>Code</th> <th>Description</th> <th>Qty</th> <th>UOM</th> </tr> </thead> <tbody> <tr> <td>VI0239A1</td> <td>SELF-TAPPIN G SCREW 4.2X25 TCB+ INOX</td> <td>2</td> <td>PZ</td> </tr> <tr> <td>VI1220A1</td> <td>4,2X12 TCB SELF-TAPPIN G SCREW</td> <td>2</td> <td>PZ</td> </tr> <tr> <td>VM1190A2</td> <td>CT BT RIGHT DOOR SPRING LATCH</td> <td>1</td> <td>PZ</td> </tr> <tr> <td>VM1192A1</td> <td>CT BT DOOR SPRING LATCH BACK COVER</td> <td>1</td> <td>PZ</td> </tr> <tr> <td>VM1460A0</td> <td>XBC/XVC RIGHT DOOR LATCH CAP</td> <td>1</td> <td>PZ</td> </tr> </tbody> </table>	Code	Description	Qty	UOM	VI0239A1	SELF-TAPPIN G SCREW 4.2X25 TCB+ INOX	2	PZ	VI1220A1	4,2X12 TCB SELF-TAPPIN G SCREW	2	PZ	VM1190A2	CT BT RIGHT DOOR SPRING LATCH	1	PZ	VM1192A1	CT BT DOOR SPRING LATCH BACK COVER	1	PZ	VM1460A0	XBC/XVC RIGHT DOOR LATCH CAP	1	PZ			
Code	Description	Qty	UOM																										
VI0239A1	SELF-TAPPIN G SCREW 4.2X25 TCB+ INOX	2	PZ																										
VI1220A1	4,2X12 TCB SELF-TAPPIN G SCREW	2	PZ																										
VM1190A2	CT BT RIGHT DOOR SPRING LATCH	1	PZ																										
VM1192A1	CT BT DOOR SPRING LATCH BACK COVER	1	PZ																										
VM1460A0	XBC/XVC RIGHT DOOR LATCH CAP	1	PZ																										
VM2281A	DOOR LATCH HOLES COVER		KVM2281A	HOLE PLATE COVER KIT	<table border="1"> <thead> <tr> <th>Code</th> <th>Description</th> <th>Qty</th> <th>UOM</th> </tr> </thead> <tbody> <tr> <td>VM2281A0</td> <td>DOOR LATCH HOLES COVER</td> <td>1</td> <td>PZ</td> </tr> </tbody> </table>	Code	Description	Qty	UOM	VM2281A0	DOOR LATCH HOLES COVER	1	PZ																
Code	Description	Qty	UOM																										
VM2281A0	DOOR LATCH HOLES COVER	1	PZ																										





COMPONENT			SPARE PART																										
Code	Description	Image	Code	Description	Components list																								
VM1192A	CT BT DOOR SPRING LATCH BACK COVER		KVM1191A	CHEFTOP/BAKERTO P DOOR LEFT LATCH KIT	<table border="1"> <thead> <tr> <th>Code</th> <th>Description</th> <th>Qty</th> <th>UOM</th> </tr> </thead> <tbody> <tr> <td>VI0239A1</td> <td>SELF-TAPPIN G SCREW 4.2X25 TCB+ INOX</td> <td>2</td> <td>PZ</td> </tr> <tr> <td>VI1220A1</td> <td>4,2X12 TCB SELF-TAPPIN G SCREW</td> <td>2</td> <td>PZ</td> </tr> <tr> <td>VM1191A2</td> <td>CT BT LEFT DOOR SPRING LATCH</td> <td>1</td> <td>PZ</td> </tr> <tr> <td>VM1192A1</td> <td>CT BT DOOR SPRING LATCH BACK COVER</td> <td>1</td> <td>PZ</td> </tr> <tr> <td>VM1460A0</td> <td>XBC/XVC RIGHT DOOR LATCH CAP</td> <td>1</td> <td>PZ</td> </tr> </tbody> </table>	Code	Description	Qty	UOM	VI0239A1	SELF-TAPPIN G SCREW 4.2X25 TCB+ INOX	2	PZ	VI1220A1	4,2X12 TCB SELF-TAPPIN G SCREW	2	PZ	VM1191A2	CT BT LEFT DOOR SPRING LATCH	1	PZ	VM1192A1	CT BT DOOR SPRING LATCH BACK COVER	1	PZ	VM1460A0	XBC/XVC RIGHT DOOR LATCH CAP	1	PZ
			Code	Description	Qty	UOM																							
VI0239A1	SELF-TAPPIN G SCREW 4.2X25 TCB+ INOX	2	PZ																										
VI1220A1	4,2X12 TCB SELF-TAPPIN G SCREW	2	PZ																										
VM1191A2	CT BT LEFT DOOR SPRING LATCH	1	PZ																										
VM1192A1	CT BT DOOR SPRING LATCH BACK COVER	1	PZ																										
VM1460A0	XBC/XVC RIGHT DOOR LATCH CAP	1	PZ																										
KVM1190A	CHEFTOP/BAKERTO P DOOR RIGHT LATCH KIT	<table border="1"> <thead> <tr> <th>Code</th> <th>Description</th> <th>Qty</th> <th>UOM</th> </tr> </thead> <tbody> <tr> <td>VI0239A1</td> <td>SELF-TAPPIN G SCREW 4.2X25 TCB+ INOX</td> <td>2</td> <td>PZ</td> </tr> <tr> <td>VI1220A1</td> <td>4,2X12 TCB SELF-TAPPIN G SCREW</td> <td>2</td> <td>PZ</td> </tr> <tr> <td>VM1190A2</td> <td>CT BT RIGHT DOOR SPRING LATCH</td> <td>1</td> <td>PZ</td> </tr> <tr> <td>VM1192A1</td> <td>CT BT DOOR SPRING LATCH BACK COVER</td> <td>1</td> <td>PZ</td> </tr> <tr> <td>VM1460A0</td> <td>XBC/XVC RIGHT DOOR LATCH CAP</td> <td>1</td> <td>PZ</td> </tr> </tbody> </table>	Code	Description	Qty	UOM	VI0239A1	SELF-TAPPIN G SCREW 4.2X25 TCB+ INOX	2	PZ	VI1220A1	4,2X12 TCB SELF-TAPPIN G SCREW	2	PZ	VM1190A2	CT BT RIGHT DOOR SPRING LATCH	1	PZ	VM1192A1	CT BT DOOR SPRING LATCH BACK COVER	1	PZ	VM1460A0	XBC/XVC RIGHT DOOR LATCH CAP	1	PZ			
Code	Description	Qty	UOM																										
VI0239A1	SELF-TAPPIN G SCREW 4.2X25 TCB+ INOX	2	PZ																										
VI1220A1	4,2X12 TCB SELF-TAPPIN G SCREW	2	PZ																										
VM1190A2	CT BT RIGHT DOOR SPRING LATCH	1	PZ																										
VM1192A1	CT BT DOOR SPRING LATCH BACK COVER	1	PZ																										
VM1460A0	XBC/XVC RIGHT DOOR LATCH CAP	1	PZ																										
VM1191A	CT BT LEFT DOOR SPRING LATCH		KVM1191A	CHEFTOP/BAKERTO P DOOR LEFT LATCH KIT	<table border="1"> <thead> <tr> <th>Code</th> <th>Description</th> <th>Qty</th> <th>UOM</th> </tr> </thead> <tbody> <tr> <td>VI0239A1</td> <td>SELF-TAPPIN G SCREW 4.2X25 TCB+ INOX</td> <td>2</td> <td>PZ</td> </tr> <tr> <td>VI1220A1</td> <td>4,2X12 TCB SELF-TAPPIN G SCREW</td> <td>2</td> <td>PZ</td> </tr> <tr> <td>VM1191A2</td> <td>CT BT LEFT DOOR SPRING LATCH</td> <td>1</td> <td>PZ</td> </tr> <tr> <td>VM1192A1</td> <td>CT BT DOOR SPRING LATCH BACK COVER</td> <td>1</td> <td>PZ</td> </tr> <tr> <td>VM1460A0</td> <td>XBC/XVC RIGHT DOOR LATCH CAP</td> <td>1</td> <td>PZ</td> </tr> </tbody> </table>	Code	Description	Qty	UOM	VI0239A1	SELF-TAPPIN G SCREW 4.2X25 TCB+ INOX	2	PZ	VI1220A1	4,2X12 TCB SELF-TAPPIN G SCREW	2	PZ	VM1191A2	CT BT LEFT DOOR SPRING LATCH	1	PZ	VM1192A1	CT BT DOOR SPRING LATCH BACK COVER	1	PZ	VM1460A0	XBC/XVC RIGHT DOOR LATCH CAP	1	PZ
Code	Description	Qty	UOM																										
VI0239A1	SELF-TAPPIN G SCREW 4.2X25 TCB+ INOX	2	PZ																										
VI1220A1	4,2X12 TCB SELF-TAPPIN G SCREW	2	PZ																										
VM1191A2	CT BT LEFT DOOR SPRING LATCH	1	PZ																										
VM1192A1	CT BT DOOR SPRING LATCH BACK COVER	1	PZ																										
VM1460A0	XBC/XVC RIGHT DOOR LATCH CAP	1	PZ																										



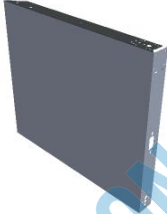
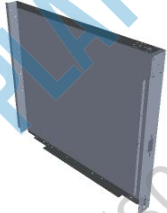

COMPONENT			SPARE PART																						
Code	Description	Image	Code	Description	Components list																				
0H2561A	6 S. DOOR COUNTERBRACKET		0H2561A0	6 S. DOOR COUNTERBRACKET																					
VM2352A	LOWER DOOR BRACKET SCREW LEFT COVER		VM2352A0	LOWER DOOR BRACKET SCREW LEFT COVER																					
VM2353A	LOWER DOOR BRACKET SCREW RIGHT COVER		VM2353A0	LOWER DOOR BRACKET SCREW RIGHT COVER																					
VM1240A	NYLON SUPPORT CAP		KVM1240A	4 PCS COUNTER BRACKET SUPPORT CAP KIT	<table border="1"> <thead> <tr> <th>Code</th> <th>Description</th> <th>Qty</th> <th>UOM</th> </tr> </thead> <tbody> <tr> <td>VM1240A0</td> <td>NYLON SUPPORT CAP</td> <td>4</td> <td>PZ</td> </tr> </tbody> </table>	Code	Description	Qty	UOM	VM1240A0	NYLON SUPPORT CAP	4	PZ												
Code	Description	Qty	UOM																						
VM1240A0	NYLON SUPPORT CAP	4	PZ																						
VM2273A	6 S. LEFT LOWER DOOR BRACKET		KVM2273A	MIND.MAPS DOOR LOWER LEFT BRACKET KIT	<table border="1"> <thead> <tr> <th>Code</th> <th>Description</th> <th>Qty</th> <th>UOM</th> </tr> </thead> <tbody> <tr> <td>0H7330A0</td> <td>DOOR LOWER BRACKET WASHER</td> <td>2</td> <td>PZ</td> </tr> <tr> <td>V11995A0</td> <td>M5X25 ST.STEEL SCREW</td> <td>4</td> <td>PZ</td> </tr> <tr> <td>VM2273A1</td> <td>MM DOOR LEFT LOWER BRACKET</td> <td>1</td> <td>PZ</td> </tr> <tr> <td>VM2352A0</td> <td>LOWER DOOR BRACKET SCREW LEFT COVER</td> <td>1</td> <td>PZ</td> </tr> </tbody> </table>	Code	Description	Qty	UOM	0H7330A0	DOOR LOWER BRACKET WASHER	2	PZ	V11995A0	M5X25 ST.STEEL SCREW	4	PZ	VM2273A1	MM DOOR LEFT LOWER BRACKET	1	PZ	VM2352A0	LOWER DOOR BRACKET SCREW LEFT COVER	1	PZ
Code	Description	Qty	UOM																						
0H7330A0	DOOR LOWER BRACKET WASHER	2	PZ																						
V11995A0	M5X25 ST.STEEL SCREW	4	PZ																						
VM2273A1	MM DOOR LEFT LOWER BRACKET	1	PZ																						
VM2352A0	LOWER DOOR BRACKET SCREW LEFT COVER	1	PZ																						

COMPONENT			SPARE PART																		
Code	Description	Image	Code	Description	Components list																
VM2273A	6 S. LEFT LOWER DOOR BRACKET		KVM2273A	MIND.MAPS DOOR LOWER LEFT BRACKET KIT	<table border="1"> <thead> <tr> <th>Code</th> <th>Description</th> <th>Qty</th> <th>UOM</th> </tr> </thead> <tbody> <tr> <td>VM2352A0</td> <td>LOWER DOOR BRACKET SCREW LEFT COVER</td> <td>1</td> <td>PZ</td> </tr> <tr> <td>VM2353A0</td> <td>LOWER DOOR BRACKET SCREW RIGHT COVER</td> <td>1</td> <td>PZ</td> </tr> <tr> <td>VM2353A0</td> <td>LOWER DOOR BRACKET SCREW RIGHT COVER</td> <td>1</td> <td>PZ</td> </tr> </tbody> </table>	Code	Description	Qty	UOM	VM2352A0	LOWER DOOR BRACKET SCREW LEFT COVER	1	PZ	VM2353A0	LOWER DOOR BRACKET SCREW RIGHT COVER	1	PZ	VM2353A0	LOWER DOOR BRACKET SCREW RIGHT COVER	1	PZ
Code	Description	Qty	UOM																		
VM2352A0	LOWER DOOR BRACKET SCREW LEFT COVER	1	PZ																		
VM2353A0	LOWER DOOR BRACKET SCREW RIGHT COVER	1	PZ																		
VM2353A0	LOWER DOOR BRACKET SCREW RIGHT COVER	1	PZ																		
0H2561A	6 S. DOOR COUNTERBRACKET		0H2561A0	6 S. DOOR COUNTERBRACKET																	
VM1240A	NYLON SUPPORT CAP		KVM1240A	4 PCS COUNTER BRACKET SUPPORT CAP KIT	<table border="1"> <thead> <tr> <th>Code</th> <th>Description</th> <th>Qty</th> <th>UOM</th> </tr> </thead> <tbody> <tr> <td>VM1240A0</td> <td>NYLON SUPPORT CAP</td> <td>4</td> <td>PZ</td> </tr> </tbody> </table>	Code	Description	Qty	UOM	VM1240A0	NYLON SUPPORT CAP	4	PZ								
Code	Description	Qty	UOM																		
VM1240A0	NYLON SUPPORT CAP	4	PZ																		
VM2298A	DOOR BRACKET UPPER COVER		KVM2298A	MIND.MAPS DOOR UPPER BRACKET COVER KIT	<table border="1"> <thead> <tr> <th>Code</th> <th>Description</th> <th>Qty</th> <th>UOM</th> </tr> </thead> <tbody> <tr> <td>V11220A0</td> <td>SELF-TAPPIN G SCREW 4,2X12 TCB</td> <td>2</td> <td>PZ</td> </tr> <tr> <td>VM2298A0</td> <td>DOOR BRACKET UPPER COVER</td> <td>1</td> <td>PZ</td> </tr> </tbody> </table>	Code	Description	Qty	UOM	V11220A0	SELF-TAPPIN G SCREW 4,2X12 TCB	2	PZ	VM2298A0	DOOR BRACKET UPPER COVER	1	PZ				
Code	Description	Qty	UOM																		
V11220A0	SELF-TAPPIN G SCREW 4,2X12 TCB	2	PZ																		
VM2298A0	DOOR BRACKET UPPER COVER	1	PZ																		
VM2271A	MM DOOR LEFT UPPER BRACKET		KVM2271A	MIND.MAPS UPPER LEFT DOOR BRACKET KIT	<table border="1"> <thead> <tr> <th>Code</th> <th>Description</th> <th>Qty</th> <th>UOM</th> </tr> </thead> <tbody> <tr> <td>V11220A1</td> <td>4,2X12 TCB SELF-TAPPIN G SCREW</td> <td>2</td> <td>PZ</td> </tr> <tr> <td>V11995A0</td> <td>M5X25 ST.STEEL SCREW</td> <td>4</td> <td>PZ</td> </tr> <tr> <td>V11997A0</td> <td>5X10X1 FLAT WASHER</td> <td>4</td> <td>PZ</td> </tr> </tbody> </table>	Code	Description	Qty	UOM	V11220A1	4,2X12 TCB SELF-TAPPIN G SCREW	2	PZ	V11995A0	M5X25 ST.STEEL SCREW	4	PZ	V11997A0	5X10X1 FLAT WASHER	4	PZ
Code	Description	Qty	UOM																		
V11220A1	4,2X12 TCB SELF-TAPPIN G SCREW	2	PZ																		
V11995A0	M5X25 ST.STEEL SCREW	4	PZ																		
V11997A0	5X10X1 FLAT WASHER	4	PZ																		

COMPONENT			SPARE PART																																														
Code	Description	Image	Code	Description	Components list																																												
VM2271A	MM DOOR LEFT UPPER BRACKET		KVM2271A	MIND.MAPS UPPER LEFT DOOR BRACKET KIT	<table border="1"> <thead> <tr> <th>Code</th> <th>Description</th> <th>Qty</th> <th>UOM</th> </tr> </thead> <tbody> <tr> <td>VM2271A0</td> <td>MM DOOR LEFT UPPER BRACKET</td> <td>1</td> <td>PZ</td> </tr> <tr> <td>VM2298A0</td> <td>DOOR BRACKET UPPER COVER</td> <td>1</td> <td>PZ</td> </tr> </tbody> </table>	Code	Description	Qty	UOM	VM2271A0	MM DOOR LEFT UPPER BRACKET	1	PZ	VM2298A0	DOOR BRACKET UPPER COVER	1	PZ																																
Code	Description	Qty	UOM																																														
VM2271A0	MM DOOR LEFT UPPER BRACKET	1	PZ																																														
VM2298A0	DOOR BRACKET UPPER COVER	1	PZ																																														
0D2298A	XEVC-0511 LEFT SIDE PANEL		0D2298A2	XEVC-0511 LEFT SIDE PANEL																																													
0D2299A	XEVC-0511 EXTERNAL RIGHT SIDE		0D2299A2	XEVC-0511 EXTERNAL RIGHT SIDE																																													
VL1067A	WASHING SYSTEM INLETS DISTRIBUTO		KVL1073A	EUR 1 ROTOR ARM PLUS CHEMICAL PUMP KIT	<table border="1"> <thead> <tr> <th>Code</th> <th>Description</th> <th>Qty</th> <th>UOM</th> </tr> </thead> <tbody> <tr> <td>GN1526A0</td> <td>INT. D.=6.9 TH=1.8 O-RIN</td> <td>1</td> <td>PZ</td> </tr> <tr> <td>RC1019A0</td> <td>D=10 ELASTIC CLAMP</td> <td>6</td> <td>PZ</td> </tr> <tr> <td>RC1130A0</td> <td>130X2,6 CLAM</td> <td>1</td> <td>PZ</td> </tr> <tr> <td>RC1242A0</td> <td>D=10 CLOSED CAP</td> <td>2</td> <td>PZ</td> </tr> <tr> <td>TB2820A0</td> <td>PIPE EPDM FOR WASHING SYSTEM</td> <td>0.120</td> <td>M</td> </tr> <tr> <td>VL1019A0</td> <td>VIBRATION PUMP</td> <td>1</td> <td>PZ</td> </tr> <tr> <td>VL1064A0</td> <td>WASHING SYSTEM OUTLETS DISTRIBUTOR</td> <td>1</td> <td>PZ</td> </tr> <tr> <td>VL1067A0</td> <td>WASHING SYSTEM INLETS DISTRIBUTOR</td> <td>1</td> <td>PZ</td> </tr> <tr> <td>VL1128A0</td> <td>BARBED CHECK VALVE D6</td> <td>1</td> <td>PZ</td> </tr> <tr> <td>VM2172A0</td> <td>PUMP LOCKING CLIP</td> <td>1</td> <td>PZ</td> </tr> </tbody> </table>	Code	Description	Qty	UOM	GN1526A0	INT. D.=6.9 TH=1.8 O-RIN	1	PZ	RC1019A0	D=10 ELASTIC CLAMP	6	PZ	RC1130A0	130X2,6 CLAM	1	PZ	RC1242A0	D=10 CLOSED CAP	2	PZ	TB2820A0	PIPE EPDM FOR WASHING SYSTEM	0.120	M	VL1019A0	VIBRATION PUMP	1	PZ	VL1064A0	WASHING SYSTEM OUTLETS DISTRIBUTOR	1	PZ	VL1067A0	WASHING SYSTEM INLETS DISTRIBUTOR	1	PZ	VL1128A0	BARBED CHECK VALVE D6	1	PZ	VM2172A0	PUMP LOCKING CLIP	1	PZ
Code	Description	Qty	UOM																																														
GN1526A0	INT. D.=6.9 TH=1.8 O-RIN	1	PZ																																														
RC1019A0	D=10 ELASTIC CLAMP	6	PZ																																														
RC1130A0	130X2,6 CLAM	1	PZ																																														
RC1242A0	D=10 CLOSED CAP	2	PZ																																														
TB2820A0	PIPE EPDM FOR WASHING SYSTEM	0.120	M																																														
VL1019A0	VIBRATION PUMP	1	PZ																																														
VL1064A0	WASHING SYSTEM OUTLETS DISTRIBUTOR	1	PZ																																														
VL1067A0	WASHING SYSTEM INLETS DISTRIBUTOR	1	PZ																																														
VL1128A0	BARBED CHECK VALVE D6	1	PZ																																														
VM2172A0	PUMP LOCKING CLIP	1	PZ																																														



COMPONENT			SPARE PART																																																																																					
Code	Description	Image	Code	Description	Components list																																																																																			
VL1019A	VIBRATION PUMP		KVL1121A	EUR MIND.MAPS HOOD CLEANING SYSTEM KIT	<table border="1"> <thead> <tr> <th>Code</th> <th>Description</th> <th>Qty</th> <th>UOM</th> </tr> </thead> <tbody> <tr> <td>0H7368A0</td> <td>S6 HOOD WATER SYSTEM PLAT</td> <td>1</td> <td>PZ</td> </tr> <tr> <td>EL1424A0</td> <td>D8 CONNECTION WATER SOLENOID VALVE</td> <td>1</td> <td>PZ</td> </tr> <tr> <td>EL1424B0</td> <td></td> <td>1</td> <td>PZ</td> </tr> <tr> <td>EL1436A0</td> <td>H2O SOLENOID JG D8 CHECK VALVE</td> <td>1</td> <td>PZ</td> </tr> <tr> <td>EL1436B0</td> <td></td> <td>1</td> <td>PZ</td> </tr> <tr> <td>GN1526A0</td> <td>INT. D.=6.9 TH=1.8 O-RIN</td> <td>1</td> <td>PZ</td> </tr> <tr> <td>RC1019A0</td> <td>D=10 ELASTIC CLAMP</td> <td>12</td> <td>PZ</td> </tr> <tr> <td>RC1242A0</td> <td>D=10 CLOSED CAP</td> <td>2</td> <td>PZ</td> </tr> <tr> <td>RC1408A0</td> <td>DOUBLE WIRE SPRING CLAMP D10.8 ZN</td> <td>2</td> <td>PZ</td> </tr> <tr> <td>TB2820A0</td> <td>PIPE EPDM FOR WASHING SYSTEM</td> <td>2.200</td> <td>M</td> </tr> <tr> <td>VI1220A1</td> <td>4,2X12 TCB SELF-TAPPIN G SCREW</td> <td>5</td> <td>PZ</td> </tr> <tr> <td>VL1019A0</td> <td>VIBRATION PUMP</td> <td>1</td> <td>PZ</td> </tr> <tr> <td>VL1053B0</td> <td>ONE WASHING SYS EXT DISTRIBUTOR</td> <td>1</td> <td>PZ</td> </tr> <tr> <td>VL1054B0</td> <td>ONE WASHING SYS INLET DISTRIBUTOR</td> <td>1</td> <td>PZ</td> </tr> <tr> <td>VL1102A1</td> <td>DETERGENT LINE FILTER + BARBED VNR 6 MM</td> <td>1</td> <td>PZ</td> </tr> <tr> <td>VL1128A0</td> <td>BARBED CHECK VALVE D6</td> <td>1</td> <td>PZ</td> </tr> <tr> <td>VM2172A0</td> <td>PUMP LOCKING CLIP</td> <td>1</td> <td>PZ</td> </tr> </tbody> </table>	Code	Description	Qty	UOM	0H7368A0	S6 HOOD WATER SYSTEM PLAT	1	PZ	EL1424A0	D8 CONNECTION WATER SOLENOID VALVE	1	PZ	EL1424B0		1	PZ	EL1436A0	H2O SOLENOID JG D8 CHECK VALVE	1	PZ	EL1436B0		1	PZ	GN1526A0	INT. D.=6.9 TH=1.8 O-RIN	1	PZ	RC1019A0	D=10 ELASTIC CLAMP	12	PZ	RC1242A0	D=10 CLOSED CAP	2	PZ	RC1408A0	DOUBLE WIRE SPRING CLAMP D10.8 ZN	2	PZ	TB2820A0	PIPE EPDM FOR WASHING SYSTEM	2.200	M	VI1220A1	4,2X12 TCB SELF-TAPPIN G SCREW	5	PZ	VL1019A0	VIBRATION PUMP	1	PZ	VL1053B0	ONE WASHING SYS EXT DISTRIBUTOR	1	PZ	VL1054B0	ONE WASHING SYS INLET DISTRIBUTOR	1	PZ	VL1102A1	DETERGENT LINE FILTER + BARBED VNR 6 MM	1	PZ	VL1128A0	BARBED CHECK VALVE D6	1	PZ	VM2172A0	PUMP LOCKING CLIP	1	PZ	KVL1120A	USA COMPACT PLUS CLEANING SYSTEM KIT	<table border="1"> <thead> <tr> <th>Code</th> <th>Description</th> <th>Qty</th> <th>UOM</th> </tr> </thead> <tbody> <tr> <td>0H7553D0</td> <td>XECC PLUS WASHING SYSTEM PLAT</td> <td>1</td> <td>PZ</td> </tr> </tbody> </table>	Code	Description	Qty	UOM	0H7553D0	XECC PLUS WASHING SYSTEM PLAT	1	PZ
			Code	Description	Qty	UOM																																																																																		
0H7368A0	S6 HOOD WATER SYSTEM PLAT	1	PZ																																																																																					
EL1424A0	D8 CONNECTION WATER SOLENOID VALVE	1	PZ																																																																																					
EL1424B0		1	PZ																																																																																					
EL1436A0	H2O SOLENOID JG D8 CHECK VALVE	1	PZ																																																																																					
EL1436B0		1	PZ																																																																																					
GN1526A0	INT. D.=6.9 TH=1.8 O-RIN	1	PZ																																																																																					
RC1019A0	D=10 ELASTIC CLAMP	12	PZ																																																																																					
RC1242A0	D=10 CLOSED CAP	2	PZ																																																																																					
RC1408A0	DOUBLE WIRE SPRING CLAMP D10.8 ZN	2	PZ																																																																																					
TB2820A0	PIPE EPDM FOR WASHING SYSTEM	2.200	M																																																																																					
VI1220A1	4,2X12 TCB SELF-TAPPIN G SCREW	5	PZ																																																																																					
VL1019A0	VIBRATION PUMP	1	PZ																																																																																					
VL1053B0	ONE WASHING SYS EXT DISTRIBUTOR	1	PZ																																																																																					
VL1054B0	ONE WASHING SYS INLET DISTRIBUTOR	1	PZ																																																																																					
VL1102A1	DETERGENT LINE FILTER + BARBED VNR 6 MM	1	PZ																																																																																					
VL1128A0	BARBED CHECK VALVE D6	1	PZ																																																																																					
VM2172A0	PUMP LOCKING CLIP	1	PZ																																																																																					
Code	Description	Qty	UOM																																																																																					
0H7553D0	XECC PLUS WASHING SYSTEM PLAT	1	PZ																																																																																					

COMPONENT			SPARE PART																																																																														
Code	Description	Image	Code	Description	Components list																																																																												
VL1019A	VIBRATION PUMP		KVL1120A	USA COMPACT PLUS CLEANING SYSTEM KIT	<table border="1"> <thead> <tr> <th>Code</th> <th>Description</th> <th>Qty</th> <th>UOM</th> </tr> </thead> <tbody> <tr> <td>EL1422A1</td> <td>1 WAY SOLENOID VALVE + D8-D10 REDUCTION</td> <td>1</td> <td>PZ</td> </tr> <tr> <td>EL1426A0</td> <td>H2O UL SOLENOID JG D8-PIPE HOLDER</td> <td>1</td> <td>PZ</td> </tr> <tr> <td>EL1426B0</td> <td></td> <td>1</td> <td>PZ</td> </tr> <tr> <td>EL1437A0</td> <td>H2O SOLENOID JG D6 UL CHECK VALVE</td> <td>1</td> <td>PZ</td> </tr> <tr> <td>GN1312A0</td> <td>RUBBER CABLE-PASSI NG DE=26 DI=15 SP=10</td> <td>1</td> <td>PZ</td> </tr> <tr> <td>GN1526A0</td> <td>INT. D.=6.9 TH=1.8 O-RIN</td> <td>1</td> <td>PZ</td> </tr> <tr> <td>RC1019A0</td> <td>D=10 ELASTIC CLAMP</td> <td>10</td> <td>PZ</td> </tr> <tr> <td>RC1242A0</td> <td>D=10 CLOSED CAP</td> <td>2</td> <td>PZ</td> </tr> <tr> <td>RC1356A0</td> <td>STRAIGHT THREADED FEMALE END 8X1/4" BSP</td> <td>1</td> <td>PZ</td> </tr> <tr> <td>TB2820A0</td> <td>PIPE EPDM FOR WASHING SYSTEM</td> <td>1.200</td> <td>M</td> </tr> <tr> <td>VH1220A1</td> <td>4,2X12 TCB SELF-TAPPIN G SCREW</td> <td>9</td> <td>PZ</td> </tr> <tr> <td>VL1019A0</td> <td>VIBRATION PUMP</td> <td>1</td> <td>PZ</td> </tr> <tr> <td>VL1054B0</td> <td>ONE WASHING SYS INLET DISTRIBUTOR</td> <td>1</td> <td>PZ</td> </tr> <tr> <td>VL1064A0</td> <td>WASHING SYSTEM OUTLETS DISTRIBUTOR</td> <td>1</td> <td>PZ</td> </tr> <tr> <td>VL1065A1</td> <td>1/4 MALE N.O. PRESSURE SWITCH</td> <td>1</td> <td>PZ</td> </tr> <tr> <td>VL1102A1</td> <td>DETERGENT LINE FILTER + BARBED VNR 6 MM</td> <td>1</td> <td>PZ</td> </tr> <tr> <td>VL1128A0</td> <td>BARBED CHECK VALVE D6</td> <td>1</td> <td>PZ</td> </tr> <tr> <td>VM2172A0</td> <td>PUMP LOCKING CLIP</td> <td>1</td> <td>PZ</td> </tr> </tbody> </table>	Code	Description	Qty	UOM	EL1422A1	1 WAY SOLENOID VALVE + D8-D10 REDUCTION	1	PZ	EL1426A0	H2O UL SOLENOID JG D8-PIPE HOLDER	1	PZ	EL1426B0		1	PZ	EL1437A0	H2O SOLENOID JG D6 UL CHECK VALVE	1	PZ	GN1312A0	RUBBER CABLE-PASSI NG DE=26 DI=15 SP=10	1	PZ	GN1526A0	INT. D.=6.9 TH=1.8 O-RIN	1	PZ	RC1019A0	D=10 ELASTIC CLAMP	10	PZ	RC1242A0	D=10 CLOSED CAP	2	PZ	RC1356A0	STRAIGHT THREADED FEMALE END 8X1/4" BSP	1	PZ	TB2820A0	PIPE EPDM FOR WASHING SYSTEM	1.200	M	VH1220A1	4,2X12 TCB SELF-TAPPIN G SCREW	9	PZ	VL1019A0	VIBRATION PUMP	1	PZ	VL1054B0	ONE WASHING SYS INLET DISTRIBUTOR	1	PZ	VL1064A0	WASHING SYSTEM OUTLETS DISTRIBUTOR	1	PZ	VL1065A1	1/4 MALE N.O. PRESSURE SWITCH	1	PZ	VL1102A1	DETERGENT LINE FILTER + BARBED VNR 6 MM	1	PZ	VL1128A0	BARBED CHECK VALVE D6	1	PZ	VM2172A0	PUMP LOCKING CLIP	1	PZ
Code	Description	Qty	UOM																																																																														
EL1422A1	1 WAY SOLENOID VALVE + D8-D10 REDUCTION	1	PZ																																																																														
EL1426A0	H2O UL SOLENOID JG D8-PIPE HOLDER	1	PZ																																																																														
EL1426B0		1	PZ																																																																														
EL1437A0	H2O SOLENOID JG D6 UL CHECK VALVE	1	PZ																																																																														
GN1312A0	RUBBER CABLE-PASSI NG DE=26 DI=15 SP=10	1	PZ																																																																														
GN1526A0	INT. D.=6.9 TH=1.8 O-RIN	1	PZ																																																																														
RC1019A0	D=10 ELASTIC CLAMP	10	PZ																																																																														
RC1242A0	D=10 CLOSED CAP	2	PZ																																																																														
RC1356A0	STRAIGHT THREADED FEMALE END 8X1/4" BSP	1	PZ																																																																														
TB2820A0	PIPE EPDM FOR WASHING SYSTEM	1.200	M																																																																														
VH1220A1	4,2X12 TCB SELF-TAPPIN G SCREW	9	PZ																																																																														
VL1019A0	VIBRATION PUMP	1	PZ																																																																														
VL1054B0	ONE WASHING SYS INLET DISTRIBUTOR	1	PZ																																																																														
VL1064A0	WASHING SYSTEM OUTLETS DISTRIBUTOR	1	PZ																																																																														
VL1065A1	1/4 MALE N.O. PRESSURE SWITCH	1	PZ																																																																														
VL1102A1	DETERGENT LINE FILTER + BARBED VNR 6 MM	1	PZ																																																																														
VL1128A0	BARBED CHECK VALVE D6	1	PZ																																																																														
VM2172A0	PUMP LOCKING CLIP	1	PZ																																																																														

COMPONENT			SPARE PART																																																																														
Code	Description	Image	Code	Description	Components list																																																																												
VL1019A	VIBRATION PUMP		KVL1119A	EUR COMPACT PLUS CLEANING SYSTEM KIT	<table border="1"> <thead> <tr> <th>Code</th> <th>Description</th> <th>Qty</th> <th>UOM</th> </tr> </thead> <tbody> <tr> <td>0H7553D0</td> <td>XECC PLUS WASHING SYSTEM PLAT</td> <td>1</td> <td>PZ</td> </tr> <tr> <td>EL1252A1</td> <td>1 WAY WATER VALVE + J.G. CONNECTION</td> <td>1</td> <td>PZ</td> </tr> <tr> <td>EL1424A0</td> <td>D8 CONNECTION WATER SOLENOID VALVE</td> <td>1</td> <td>PZ</td> </tr> <tr> <td>EL1424B0</td> <td></td> <td>1</td> <td>PZ</td> </tr> <tr> <td>EL1436A0</td> <td>H2O SOLENOID JG D8 CHECK VALVE</td> <td>1</td> <td>PZ</td> </tr> <tr> <td>EL1436B0</td> <td></td> <td>1</td> <td>PZ</td> </tr> <tr> <td>GN1312A0</td> <td>RUBBER CABLE-PASSI NG DE=26 DI=15 SP=10</td> <td>1</td> <td>PZ</td> </tr> <tr> <td>GN1526A0</td> <td>INT. D.=6.9 TH=1.8 O-RIN</td> <td>1</td> <td>PZ</td> </tr> <tr> <td>RC1019A0</td> <td>D=10 ELASTIC CLAMP</td> <td>11</td> <td>PZ</td> </tr> <tr> <td>RC1242A0</td> <td>D=10 CLOSED CAP</td> <td>2</td> <td>PZ</td> </tr> <tr> <td>RC1356A0</td> <td>STRAIGHT THREADED FEMALE END 8X1/4" BSP</td> <td>1</td> <td>PZ</td> </tr> <tr> <td>TB2820A0</td> <td>PIPE EPDM FOR WASHING SYSTEM</td> <td>1.200</td> <td>M</td> </tr> <tr> <td>VH1220A1</td> <td>4,2X12 TCB SELF-TAPPIN G SCREW</td> <td>16</td> <td>PZ</td> </tr> <tr> <td>VL1019A0</td> <td>VIBRATION PUMP</td> <td>1</td> <td>PZ</td> </tr> <tr> <td>VL1054B0</td> <td>ONE WASHING SYS INLET DISTRIBUTOR</td> <td>1</td> <td>PZ</td> </tr> <tr> <td>VL1064A0</td> <td>WASHING SYSTEM OUTLETS DISTRIBUTOR</td> <td>1</td> <td>PZ</td> </tr> <tr> <td>VL1065A1</td> <td>1/4 MALE N.O. PRESSURE SWITCH</td> <td>1</td> <td>PZ</td> </tr> <tr> <td>VL1102A1</td> <td>DETERGENT LINE FILTER + BARBED VNR 6 MM</td> <td>1</td> <td>PZ</td> </tr> </tbody> </table>	Code	Description	Qty	UOM	0H7553D0	XECC PLUS WASHING SYSTEM PLAT	1	PZ	EL1252A1	1 WAY WATER VALVE + J.G. CONNECTION	1	PZ	EL1424A0	D8 CONNECTION WATER SOLENOID VALVE	1	PZ	EL1424B0		1	PZ	EL1436A0	H2O SOLENOID JG D8 CHECK VALVE	1	PZ	EL1436B0		1	PZ	GN1312A0	RUBBER CABLE-PASSI NG DE=26 DI=15 SP=10	1	PZ	GN1526A0	INT. D.=6.9 TH=1.8 O-RIN	1	PZ	RC1019A0	D=10 ELASTIC CLAMP	11	PZ	RC1242A0	D=10 CLOSED CAP	2	PZ	RC1356A0	STRAIGHT THREADED FEMALE END 8X1/4" BSP	1	PZ	TB2820A0	PIPE EPDM FOR WASHING SYSTEM	1.200	M	VH1220A1	4,2X12 TCB SELF-TAPPIN G SCREW	16	PZ	VL1019A0	VIBRATION PUMP	1	PZ	VL1054B0	ONE WASHING SYS INLET DISTRIBUTOR	1	PZ	VL1064A0	WASHING SYSTEM OUTLETS DISTRIBUTOR	1	PZ	VL1065A1	1/4 MALE N.O. PRESSURE SWITCH	1	PZ	VL1102A1	DETERGENT LINE FILTER + BARBED VNR 6 MM	1	PZ
Code	Description	Qty	UOM																																																																														
0H7553D0	XECC PLUS WASHING SYSTEM PLAT	1	PZ																																																																														
EL1252A1	1 WAY WATER VALVE + J.G. CONNECTION	1	PZ																																																																														
EL1424A0	D8 CONNECTION WATER SOLENOID VALVE	1	PZ																																																																														
EL1424B0		1	PZ																																																																														
EL1436A0	H2O SOLENOID JG D8 CHECK VALVE	1	PZ																																																																														
EL1436B0		1	PZ																																																																														
GN1312A0	RUBBER CABLE-PASSI NG DE=26 DI=15 SP=10	1	PZ																																																																														
GN1526A0	INT. D.=6.9 TH=1.8 O-RIN	1	PZ																																																																														
RC1019A0	D=10 ELASTIC CLAMP	11	PZ																																																																														
RC1242A0	D=10 CLOSED CAP	2	PZ																																																																														
RC1356A0	STRAIGHT THREADED FEMALE END 8X1/4" BSP	1	PZ																																																																														
TB2820A0	PIPE EPDM FOR WASHING SYSTEM	1.200	M																																																																														
VH1220A1	4,2X12 TCB SELF-TAPPIN G SCREW	16	PZ																																																																														
VL1019A0	VIBRATION PUMP	1	PZ																																																																														
VL1054B0	ONE WASHING SYS INLET DISTRIBUTOR	1	PZ																																																																														
VL1064A0	WASHING SYSTEM OUTLETS DISTRIBUTOR	1	PZ																																																																														
VL1065A1	1/4 MALE N.O. PRESSURE SWITCH	1	PZ																																																																														
VL1102A1	DETERGENT LINE FILTER + BARBED VNR 6 MM	1	PZ																																																																														

COMPONENT			SPARE PART																																																											
Code	Description	Image	Code	Description	Components list																																																									
VL1019A	VIBRATION PUMP		KVL1119A	EUR COMPACT PLUS CLEANING SYSTEM KIT	<table border="1"> <thead> <tr> <th>Code</th> <th>Description</th> <th>Qty</th> <th>UOM</th> </tr> </thead> <tbody> <tr> <td>VL1128A0</td> <td>BARBED CHECK VALVE D6</td> <td>1</td> <td>PZ</td> </tr> <tr> <td>VM2172A0</td> <td>PUMP LOCKING CLIP</td> <td>1</td> <td>PZ</td> </tr> </tbody> </table>	Code	Description	Qty	UOM	VL1128A0	BARBED CHECK VALVE D6	1	PZ	VM2172A0	PUMP LOCKING CLIP	1	PZ																																													
			Code	Description	Qty	UOM																																																								
VL1128A0	BARBED CHECK VALVE D6	1	PZ																																																											
VM2172A0	PUMP LOCKING CLIP	1	PZ																																																											
KVL1118A	EUR COMPACT ONE CLEANING SYSTEM KIT	<table border="1"> <thead> <tr> <th>Code</th> <th>Description</th> <th>Qty</th> <th>UOM</th> </tr> </thead> <tbody> <tr> <td>0H7173C0</td> <td>XECC ONE WASHING SYSTEM PLAT</td> <td>1</td> <td>PZ</td> </tr> <tr> <td>EL1436A0</td> <td>H2O SOLENOID JG D8 CHECK VALVE</td> <td>1</td> <td>PZ</td> </tr> <tr> <td>EL1436B0</td> <td></td> <td>1</td> <td>PZ</td> </tr> <tr> <td>GN1526A0</td> <td>INT. D.=6.9 TH=1.8 O-RIN</td> <td>1</td> <td>PZ</td> </tr> <tr> <td>RC1019A0</td> <td>D=10 ELASTIC CLAMP</td> <td>12</td> <td>PZ</td> </tr> <tr> <td>RC1242A0</td> <td>D=10 CLOSED CAP</td> <td>2</td> <td>PZ</td> </tr> <tr> <td>TB2820A0</td> <td>PIPE EPDM FOR WASHING SYSTEM</td> <td>1.200</td> <td>M</td> </tr> <tr> <td>VI1220A1</td> <td>4,2X12 TCB SELF-TAPPIN G SCREW</td> <td>6</td> <td>PZ</td> </tr> <tr> <td>VL1019A0</td> <td>VIBRATION PUMP</td> <td>1</td> <td>PZ</td> </tr> <tr> <td>VL1053B0</td> <td>ONE WASHING SYS EXT DISTRIBUTOR</td> <td>1</td> <td>PZ</td> </tr> <tr> <td>VL1054B0</td> <td>ONE WASHING SYS INLET DISTRIBUTOR</td> <td>1</td> <td>PZ</td> </tr> <tr> <td>VL1102A1</td> <td>DETERGENT LINE FILTER + BARBED VNR 6 MM</td> <td>1</td> <td>PZ</td> </tr> <tr> <td>VL1128A0</td> <td>BARBED CHECK VALVE D6</td> <td>1</td> <td>PZ</td> </tr> <tr> <td>VM2172A0</td> <td>PUMP LOCKING CLIP</td> <td>1</td> <td>PZ</td> </tr> </tbody> </table>	Code	Description	Qty	UOM	0H7173C0	XECC ONE WASHING SYSTEM PLAT	1	PZ	EL1436A0	H2O SOLENOID JG D8 CHECK VALVE	1	PZ	EL1436B0		1	PZ	GN1526A0	INT. D.=6.9 TH=1.8 O-RIN	1	PZ	RC1019A0	D=10 ELASTIC CLAMP	12	PZ	RC1242A0	D=10 CLOSED CAP	2	PZ	TB2820A0	PIPE EPDM FOR WASHING SYSTEM	1.200	M	VI1220A1	4,2X12 TCB SELF-TAPPIN G SCREW	6	PZ	VL1019A0	VIBRATION PUMP	1	PZ	VL1053B0	ONE WASHING SYS EXT DISTRIBUTOR	1	PZ	VL1054B0	ONE WASHING SYS INLET DISTRIBUTOR	1	PZ	VL1102A1	DETERGENT LINE FILTER + BARBED VNR 6 MM	1	PZ	VL1128A0	BARBED CHECK VALVE D6	1	PZ	VM2172A0	PUMP LOCKING CLIP	1	PZ
Code	Description	Qty	UOM																																																											
0H7173C0	XECC ONE WASHING SYSTEM PLAT	1	PZ																																																											
EL1436A0	H2O SOLENOID JG D8 CHECK VALVE	1	PZ																																																											
EL1436B0		1	PZ																																																											
GN1526A0	INT. D.=6.9 TH=1.8 O-RIN	1	PZ																																																											
RC1019A0	D=10 ELASTIC CLAMP	12	PZ																																																											
RC1242A0	D=10 CLOSED CAP	2	PZ																																																											
TB2820A0	PIPE EPDM FOR WASHING SYSTEM	1.200	M																																																											
VI1220A1	4,2X12 TCB SELF-TAPPIN G SCREW	6	PZ																																																											
VL1019A0	VIBRATION PUMP	1	PZ																																																											
VL1053B0	ONE WASHING SYS EXT DISTRIBUTOR	1	PZ																																																											
VL1054B0	ONE WASHING SYS INLET DISTRIBUTOR	1	PZ																																																											
VL1102A1	DETERGENT LINE FILTER + BARBED VNR 6 MM	1	PZ																																																											
VL1128A0	BARBED CHECK VALVE D6	1	PZ																																																											
VM2172A0	PUMP LOCKING CLIP	1	PZ																																																											
KVL1109A	EUR 2 ROTOR ARMS ONE CLEANING SYSTEM KIT	<table border="1"> <thead> <tr> <th>Code</th> <th>Description</th> <th>Qty</th> <th>UOM</th> </tr> </thead> <tbody> <tr> <td>0H7324A0</td> <td>ONE OVENS WASHING SYST HOLDING PLATE</td> <td>2</td> <td>PZ</td> </tr> </tbody> </table>	Code	Description	Qty	UOM	0H7324A0	ONE OVENS WASHING SYST HOLDING PLATE	2	PZ																																																				
Code	Description	Qty	UOM																																																											
0H7324A0	ONE OVENS WASHING SYST HOLDING PLATE	2	PZ																																																											





COMPONENT			SPARE PART																																																																																									
Code	Description	Image	Code	Description	Components list																																																																																							
VL1019A	VIBRATION PUMP		KVL1109A	EUR 2 ROTOR ARMS ONE CLEANING SYSTEM KIT	<table border="1"> <thead> <tr> <th>Code</th> <th>Description</th> <th>Qty</th> <th>UOM</th> </tr> </thead> <tbody> <tr> <td>0H7515A0</td> <td>XEVC-2011-E1 R DOUBLE WASHING SYS PLATE</td> <td>1</td> <td>PZ</td> </tr> <tr> <td>CH1000A0</td> <td>SNIP PIPE CUTTER</td> <td>1</td> <td>PZ</td> </tr> <tr> <td>EL1115A0</td> <td>Ø8 Y CONNECTION</td> <td>1</td> <td>PZ</td> </tr> <tr> <td>EL1436A0</td> <td>H2O SOLENOID JG D8 CHECK VALVE</td> <td>2</td> <td>PZ</td> </tr> <tr> <td>EL1436B0</td> <td></td> <td>2</td> <td>PZ</td> </tr> <tr> <td>GN1526A0</td> <td>INT. D.=6.9 TH=1.8 O-RIN</td> <td>2</td> <td>PZ</td> </tr> <tr> <td>RC1006A0</td> <td>D8 PET PIPE GUIDE BEND</td> <td>4</td> <td>PZ</td> </tr> <tr> <td>RC1019A0</td> <td>D=10 ELASTIC CLAMP</td> <td>26</td> <td>PZ</td> </tr> <tr> <td>RC1242A0</td> <td>D=10 CLOSED CAP</td> <td>4</td> <td>PZ</td> </tr> <tr> <td>TB1818A0</td> <td>JG Ø8 BLUE PE PIPE</td> <td>1.640</td> <td>M</td> </tr> <tr> <td>TB2820A0</td> <td>PIPE EPDM FOR WASHING SYSTEM</td> <td>3.940</td> <td>M</td> </tr> <tr> <td>VI1220A1</td> <td>4,2X12 TCB SELF-TAPPIN G SCREW</td> <td>8</td> <td>PZ</td> </tr> <tr> <td>VL1019A0</td> <td>VIBRATION PUMP</td> <td>2</td> <td>PZ</td> </tr> <tr> <td>VL1053B0</td> <td>ONE WASHING SYS EXT DISTRIBUTOR</td> <td>2</td> <td>PZ</td> </tr> <tr> <td>VL1054B0</td> <td>ONE WASHING SYS INLET DISTRIBUTOR</td> <td>2</td> <td>PZ</td> </tr> <tr> <td>VL1102A1</td> <td>DETERGENT LINE FILTER + BARBED VNR 6 MM</td> <td>2</td> <td>PZ</td> </tr> <tr> <td>VL1128A0</td> <td>BARBED CHECK VALVE D6</td> <td>2</td> <td>PZ</td> </tr> <tr> <td>VM2172A0</td> <td>PUMP LOCKING CLIP</td> <td>2</td> <td>PZ</td> </tr> </tbody> </table>	Code	Description	Qty	UOM	0H7515A0	XEVC-2011-E1 R DOUBLE WASHING SYS PLATE	1	PZ	CH1000A0	SNIP PIPE CUTTER	1	PZ	EL1115A0	Ø8 Y CONNECTION	1	PZ	EL1436A0	H2O SOLENOID JG D8 CHECK VALVE	2	PZ	EL1436B0		2	PZ	GN1526A0	INT. D.=6.9 TH=1.8 O-RIN	2	PZ	RC1006A0	D8 PET PIPE GUIDE BEND	4	PZ	RC1019A0	D=10 ELASTIC CLAMP	26	PZ	RC1242A0	D=10 CLOSED CAP	4	PZ	TB1818A0	JG Ø8 BLUE PE PIPE	1.640	M	TB2820A0	PIPE EPDM FOR WASHING SYSTEM	3.940	M	VI1220A1	4,2X12 TCB SELF-TAPPIN G SCREW	8	PZ	VL1019A0	VIBRATION PUMP	2	PZ	VL1053B0	ONE WASHING SYS EXT DISTRIBUTOR	2	PZ	VL1054B0	ONE WASHING SYS INLET DISTRIBUTOR	2	PZ	VL1102A1	DETERGENT LINE FILTER + BARBED VNR 6 MM	2	PZ	VL1128A0	BARBED CHECK VALVE D6	2	PZ	VM2172A0	PUMP LOCKING CLIP	2	PZ	KVL1108A	04EU ONE EUR 1 ROTOR CLEANING SYSTEM KIT	<table border="1"> <thead> <tr> <th>Code</th> <th>Description</th> <th>Qty</th> <th>UOM</th> </tr> </thead> <tbody> <tr> <td>0H7511A0</td> <td>ONE OVENS WASHING SYST HOLDING PLATE</td> <td>1</td> <td>PZ</td> </tr> </tbody> </table>	Code	Description	Qty	UOM	0H7511A0	ONE OVENS WASHING SYST HOLDING PLATE	1	PZ
			Code	Description	Qty	UOM																																																																																						
0H7515A0	XEVC-2011-E1 R DOUBLE WASHING SYS PLATE	1	PZ																																																																																									
CH1000A0	SNIP PIPE CUTTER	1	PZ																																																																																									
EL1115A0	Ø8 Y CONNECTION	1	PZ																																																																																									
EL1436A0	H2O SOLENOID JG D8 CHECK VALVE	2	PZ																																																																																									
EL1436B0		2	PZ																																																																																									
GN1526A0	INT. D.=6.9 TH=1.8 O-RIN	2	PZ																																																																																									
RC1006A0	D8 PET PIPE GUIDE BEND	4	PZ																																																																																									
RC1019A0	D=10 ELASTIC CLAMP	26	PZ																																																																																									
RC1242A0	D=10 CLOSED CAP	4	PZ																																																																																									
TB1818A0	JG Ø8 BLUE PE PIPE	1.640	M																																																																																									
TB2820A0	PIPE EPDM FOR WASHING SYSTEM	3.940	M																																																																																									
VI1220A1	4,2X12 TCB SELF-TAPPIN G SCREW	8	PZ																																																																																									
VL1019A0	VIBRATION PUMP	2	PZ																																																																																									
VL1053B0	ONE WASHING SYS EXT DISTRIBUTOR	2	PZ																																																																																									
VL1054B0	ONE WASHING SYS INLET DISTRIBUTOR	2	PZ																																																																																									
VL1102A1	DETERGENT LINE FILTER + BARBED VNR 6 MM	2	PZ																																																																																									
VL1128A0	BARBED CHECK VALVE D6	2	PZ																																																																																									
VM2172A0	PUMP LOCKING CLIP	2	PZ																																																																																									
Code	Description	Qty	UOM																																																																																									
0H7511A0	ONE OVENS WASHING SYST HOLDING PLATE	1	PZ																																																																																									

COMPONENT			SPARE PART																																																																																													
Code	Description	Image	Code	Description	Components list																																																																																											
VL1019A	VIBRATION PUMP		KVL1108A	04EU ONE EUR 1 ROTOR CLEANING SYSTEM KIT	<table border="1"> <thead> <tr> <th>Code</th> <th>Description</th> <th>Qty</th> <th>UOM</th> </tr> </thead> <tbody> <tr> <td>EL1436A0</td> <td>H2O SOLENOID JG D8 CHECK VALVE</td> <td>1</td> <td>PZ</td> </tr> <tr> <td>EL1436B0</td> <td></td> <td>1</td> <td>PZ</td> </tr> <tr> <td>GN1526A0</td> <td>INT. D.=6.9 TH=1.8 O-RIN</td> <td>1</td> <td>PZ</td> </tr> <tr> <td>RC1006A0</td> <td>D8 PET PIPE GUIDE BEND</td> <td>2</td> <td>PZ</td> </tr> <tr> <td>RC1019A0</td> <td>D=10 ELASTIC CLAMP</td> <td>17</td> <td>PZ</td> </tr> <tr> <td>RC1242A0</td> <td>D=10 CLOSED CAP</td> <td>2</td> <td>PZ</td> </tr> <tr> <td>TB1818A0</td> <td>JG Ø8 BLUE PE PIPE</td> <td>0.320</td> <td>M</td> </tr> <tr> <td>TB2820A0</td> <td>PIPE EPDM FOR WASHING SYSTEM</td> <td>1.380</td> <td>M</td> </tr> <tr> <td>VI1220A1</td> <td>4,2X12 TCB SELF-TAPPIN G.SCREW</td> <td>1</td> <td>PZ</td> </tr> <tr> <td>VL1019A0</td> <td>VIBRATION PUMP</td> <td>2</td> <td>PZ</td> </tr> <tr> <td>VL1053B0</td> <td>ONE WASHING SYS EXT DISTRIBUTOR</td> <td>1</td> <td>PZ</td> </tr> <tr> <td>VL1054B0</td> <td>ONE WASHING SYS INLET DISTRIBUTOR</td> <td>1</td> <td>PZ</td> </tr> <tr> <td>VL1128A0</td> <td>BARBED CHECK VALVE D6</td> <td>1</td> <td>PZ</td> </tr> <tr> <td>VM2172A0</td> <td>PUMP LOCKING CLIP</td> <td>1</td> <td>PZ</td> </tr> </tbody> </table>	Code	Description	Qty	UOM	EL1436A0	H2O SOLENOID JG D8 CHECK VALVE	1	PZ	EL1436B0		1	PZ	GN1526A0	INT. D.=6.9 TH=1.8 O-RIN	1	PZ	RC1006A0	D8 PET PIPE GUIDE BEND	2	PZ	RC1019A0	D=10 ELASTIC CLAMP	17	PZ	RC1242A0	D=10 CLOSED CAP	2	PZ	TB1818A0	JG Ø8 BLUE PE PIPE	0.320	M	TB2820A0	PIPE EPDM FOR WASHING SYSTEM	1.380	M	VI1220A1	4,2X12 TCB SELF-TAPPIN G.SCREW	1	PZ	VL1019A0	VIBRATION PUMP	2	PZ	VL1053B0	ONE WASHING SYS EXT DISTRIBUTOR	1	PZ	VL1054B0	ONE WASHING SYS INLET DISTRIBUTOR	1	PZ	VL1128A0	BARBED CHECK VALVE D6	1	PZ	VM2172A0	PUMP LOCKING CLIP	1	PZ	KVL1106A	EUR 1 ROTOR ARM ONE CLEANING SYSTEM KIT	<table border="1"> <thead> <tr> <th>Code</th> <th>Description</th> <th>Qty</th> <th>UOM</th> </tr> </thead> <tbody> <tr> <td>0H7819A0</td> <td>ONE WASHING SYS SUPPORT WITH STEAM VALVE</td> <td>1</td> <td>PZ</td> </tr> <tr> <td>EL1436A0</td> <td>H2O SOLENOID JG D8 CHECK VALVE</td> <td>1</td> <td>PZ</td> </tr> <tr> <td>EL1436B0</td> <td></td> <td>1</td> <td>PZ</td> </tr> <tr> <td>GN1526A0</td> <td>INT. D.=6.9 TH=1.8 O-RIN</td> <td>1</td> <td>PZ</td> </tr> <tr> <td>RC1242A0</td> <td>D=10 CLOSED CAP</td> <td>2</td> <td>PZ</td> </tr> <tr> <td>TB2820A0</td> <td>PIPE EPDM FOR WASHING SYSTEM</td> <td>1.420</td> <td>M</td> </tr> </tbody> </table>	Code	Description	Qty	UOM	0H7819A0	ONE WASHING SYS SUPPORT WITH STEAM VALVE	1	PZ	EL1436A0	H2O SOLENOID JG D8 CHECK VALVE	1	PZ	EL1436B0		1	PZ	GN1526A0	INT. D.=6.9 TH=1.8 O-RIN	1	PZ	RC1242A0	D=10 CLOSED CAP	2	PZ	TB2820A0	PIPE EPDM FOR WASHING SYSTEM	1.420	M
			Code	Description	Qty	UOM																																																																																										
EL1436A0	H2O SOLENOID JG D8 CHECK VALVE	1	PZ																																																																																													
EL1436B0		1	PZ																																																																																													
GN1526A0	INT. D.=6.9 TH=1.8 O-RIN	1	PZ																																																																																													
RC1006A0	D8 PET PIPE GUIDE BEND	2	PZ																																																																																													
RC1019A0	D=10 ELASTIC CLAMP	17	PZ																																																																																													
RC1242A0	D=10 CLOSED CAP	2	PZ																																																																																													
TB1818A0	JG Ø8 BLUE PE PIPE	0.320	M																																																																																													
TB2820A0	PIPE EPDM FOR WASHING SYSTEM	1.380	M																																																																																													
VI1220A1	4,2X12 TCB SELF-TAPPIN G.SCREW	1	PZ																																																																																													
VL1019A0	VIBRATION PUMP	2	PZ																																																																																													
VL1053B0	ONE WASHING SYS EXT DISTRIBUTOR	1	PZ																																																																																													
VL1054B0	ONE WASHING SYS INLET DISTRIBUTOR	1	PZ																																																																																													
VL1128A0	BARBED CHECK VALVE D6	1	PZ																																																																																													
VM2172A0	PUMP LOCKING CLIP	1	PZ																																																																																													
Code	Description	Qty	UOM																																																																																													
0H7819A0	ONE WASHING SYS SUPPORT WITH STEAM VALVE	1	PZ																																																																																													
EL1436A0	H2O SOLENOID JG D8 CHECK VALVE	1	PZ																																																																																													
EL1436B0		1	PZ																																																																																													
GN1526A0	INT. D.=6.9 TH=1.8 O-RIN	1	PZ																																																																																													
RC1242A0	D=10 CLOSED CAP	2	PZ																																																																																													
TB2820A0	PIPE EPDM FOR WASHING SYSTEM	1.420	M																																																																																													

COMPONENT			SPARE PART																																											
Code	Description	Image	Code	Description	Components list																																									
VL1019A	VIBRATION PUMP		KVL1106A	EUR 1 ROTOR ARM ONE CLEANING SYSTEM KIT	<table border="1"> <thead> <tr> <th>Code</th> <th>Description</th> <th>Qty</th> <th>UOM</th> </tr> </thead> <tbody> <tr> <td>VI1220A1</td> <td>4,2X12 TCB SELF-TAPPIN G SCREW</td> <td>1</td> <td>PZ</td> </tr> <tr> <td>VL1019A0</td> <td>VIBRATION PUMP</td> <td>1</td> <td>PZ</td> </tr> <tr> <td>VL1053B0</td> <td>ONE WASHING SYS EXT DISTRIBUTOR</td> <td>1</td> <td>PZ</td> </tr> <tr> <td>VL1054B0</td> <td>ONE WASHING SYS INLET DISTRIBUTOR</td> <td>1</td> <td>PZ</td> </tr> <tr> <td>VL1102A1</td> <td>DETERGENT LINE FILTER + BARBED VNR 6 MM</td> <td>1</td> <td>PZ</td> </tr> <tr> <td>VL1128A0</td> <td>BARBED CHECK VALVE D6</td> <td>1</td> <td>PZ</td> </tr> <tr> <td>VM2172A0</td> <td>PUMP LOCKING CLIP</td> <td>1</td> <td>PZ</td> </tr> </tbody> </table>	Code	Description	Qty	UOM	VI1220A1	4,2X12 TCB SELF-TAPPIN G SCREW	1	PZ	VL1019A0	VIBRATION PUMP	1	PZ	VL1053B0	ONE WASHING SYS EXT DISTRIBUTOR	1	PZ	VL1054B0	ONE WASHING SYS INLET DISTRIBUTOR	1	PZ	VL1102A1	DETERGENT LINE FILTER + BARBED VNR 6 MM	1	PZ	VL1128A0	BARBED CHECK VALVE D6	1	PZ	VM2172A0	PUMP LOCKING CLIP	1	PZ									
			Code	Description	Qty	UOM																																								
VI1220A1	4,2X12 TCB SELF-TAPPIN G SCREW	1	PZ																																											
VL1019A0	VIBRATION PUMP	1	PZ																																											
VL1053B0	ONE WASHING SYS EXT DISTRIBUTOR	1	PZ																																											
VL1054B0	ONE WASHING SYS INLET DISTRIBUTOR	1	PZ																																											
VL1102A1	DETERGENT LINE FILTER + BARBED VNR 6 MM	1	PZ																																											
VL1128A0	BARBED CHECK VALVE D6	1	PZ																																											
VM2172A0	PUMP LOCKING CLIP	1	PZ																																											
KVL1105A	USA 2 ROTOR ARMS PLUS CLEANING SYSTEM KIT	<table border="1"> <thead> <tr> <th>Code</th> <th>Description</th> <th>Qty</th> <th>UOM</th> </tr> </thead> <tbody> <tr> <td>0H7820A0</td> <td>PLUS WASHING SY SUPPORT WITH STEAM VALVE</td> <td>1</td> <td>PZ</td> </tr> <tr> <td>EL1422A1</td> <td>1 WAY SOLENOID VALVE + D8-D10 REDUCTION</td> <td>1</td> <td>PZ</td> </tr> <tr> <td>EL1426A0</td> <td>H2O UL SOLENOID JG D8-PIPE HOLDER</td> <td>2</td> <td>PZ</td> </tr> <tr> <td>EL1426B0</td> <td></td> <td>2</td> <td>PZ</td> </tr> <tr> <td>EL1437A0</td> <td>H2O SOLENOID JG D6 UL CHECK VALVE</td> <td>1</td> <td>PZ</td> </tr> <tr> <td>GN1526A0</td> <td>INT. D.=6.9 TH=1.8 O-RIN</td> <td>1</td> <td>PZ</td> </tr> <tr> <td>RC1019A0</td> <td>D=10 ELASTIC CLAMP</td> <td>12</td> <td>PZ</td> </tr> <tr> <td>RC1130A0</td> <td>130X2,6 CLAM</td> <td>1</td> <td>PZ</td> </tr> <tr> <td>RC1242A0</td> <td>D=10 CLOSED CAP</td> <td>2</td> <td>PZ</td> </tr> <tr> <td>RC1356A0</td> <td>STRAIGHT THREADED FEMALE END 8X1/4" BSP</td> <td>1</td> <td>PZ</td> </tr> </tbody> </table>	Code	Description	Qty	UOM	0H7820A0	PLUS WASHING SY SUPPORT WITH STEAM VALVE	1	PZ	EL1422A1	1 WAY SOLENOID VALVE + D8-D10 REDUCTION	1	PZ	EL1426A0	H2O UL SOLENOID JG D8-PIPE HOLDER	2	PZ	EL1426B0		2	PZ	EL1437A0	H2O SOLENOID JG D6 UL CHECK VALVE	1	PZ	GN1526A0	INT. D.=6.9 TH=1.8 O-RIN	1	PZ	RC1019A0	D=10 ELASTIC CLAMP	12	PZ	RC1130A0	130X2,6 CLAM	1	PZ	RC1242A0	D=10 CLOSED CAP	2	PZ	RC1356A0	STRAIGHT THREADED FEMALE END 8X1/4" BSP	1	PZ
Code	Description	Qty	UOM																																											
0H7820A0	PLUS WASHING SY SUPPORT WITH STEAM VALVE	1	PZ																																											
EL1422A1	1 WAY SOLENOID VALVE + D8-D10 REDUCTION	1	PZ																																											
EL1426A0	H2O UL SOLENOID JG D8-PIPE HOLDER	2	PZ																																											
EL1426B0		2	PZ																																											
EL1437A0	H2O SOLENOID JG D6 UL CHECK VALVE	1	PZ																																											
GN1526A0	INT. D.=6.9 TH=1.8 O-RIN	1	PZ																																											
RC1019A0	D=10 ELASTIC CLAMP	12	PZ																																											
RC1130A0	130X2,6 CLAM	1	PZ																																											
RC1242A0	D=10 CLOSED CAP	2	PZ																																											
RC1356A0	STRAIGHT THREADED FEMALE END 8X1/4" BSP	1	PZ																																											

COMPONENT			SPARE PART																																										
Code	Description	Image	Code	Description	Components list																																								
VL1019A	VIBRATION PUMP		KVL1105A	USA 2 ROTOR ARMS PLUS CLEANING SYSTEM KIT	<table border="1"> <thead> <tr> <th>Code</th> <th>Description</th> <th>Qty</th> <th>UOM</th> </tr> </thead> <tbody> <tr> <td>TB2820A0</td> <td>PIPE EPDM FOR WASHING SYSTEM</td> <td>1.410</td> <td>M</td> </tr> <tr> <td>VI1220A1</td> <td>4,2X12 TCB SELF-TAPPING SCREW</td> <td>3</td> <td>PZ</td> </tr> <tr> <td>VL1019A0</td> <td>VIBRATION PUMP</td> <td>1</td> <td>PZ</td> </tr> <tr> <td>VL1065A1</td> <td>1/4 MALE N.O. PRESSURE SWITCH</td> <td>1</td> <td>PZ</td> </tr> <tr> <td>VL1067A0</td> <td>WASHING SYSTEM INLETS DISTRIBUTOR</td> <td>1</td> <td>PZ</td> </tr> <tr> <td>VL1092A0</td> <td>WASHING SYSTEM OUTLET DOUBLE DISTRIBUTOR</td> <td>1</td> <td>PZ</td> </tr> <tr> <td>VL1102A1</td> <td>DETERGENT LINE FILTER + BARBED VNR 6 MM</td> <td>1</td> <td>PZ</td> </tr> <tr> <td>VL1128A0</td> <td>BARBED CHECK VALVE D6</td> <td>1</td> <td>PZ</td> </tr> <tr> <td>VM2172A0</td> <td>PUMP LOCKING CLIP</td> <td>1</td> <td>PZ</td> </tr> </tbody> </table>	Code	Description	Qty	UOM	TB2820A0	PIPE EPDM FOR WASHING SYSTEM	1.410	M	VI1220A1	4,2X12 TCB SELF-TAPPING SCREW	3	PZ	VL1019A0	VIBRATION PUMP	1	PZ	VL1065A1	1/4 MALE N.O. PRESSURE SWITCH	1	PZ	VL1067A0	WASHING SYSTEM INLETS DISTRIBUTOR	1	PZ	VL1092A0	WASHING SYSTEM OUTLET DOUBLE DISTRIBUTOR	1	PZ	VL1102A1	DETERGENT LINE FILTER + BARBED VNR 6 MM	1	PZ	VL1128A0	BARBED CHECK VALVE D6	1	PZ	VM2172A0	PUMP LOCKING CLIP	1	PZ
			Code	Description	Qty	UOM																																							
TB2820A0	PIPE EPDM FOR WASHING SYSTEM	1.410	M																																										
VI1220A1	4,2X12 TCB SELF-TAPPING SCREW	3	PZ																																										
VL1019A0	VIBRATION PUMP	1	PZ																																										
VL1065A1	1/4 MALE N.O. PRESSURE SWITCH	1	PZ																																										
VL1067A0	WASHING SYSTEM INLETS DISTRIBUTOR	1	PZ																																										
VL1092A0	WASHING SYSTEM OUTLET DOUBLE DISTRIBUTOR	1	PZ																																										
VL1102A1	DETERGENT LINE FILTER + BARBED VNR 6 MM	1	PZ																																										
VL1128A0	BARBED CHECK VALVE D6	1	PZ																																										
VM2172A0	PUMP LOCKING CLIP	1	PZ																																										
KVL1104A	USA 1 ROTOR ARM PLUS CLEANING SYSTEM KIT	<table border="1"> <thead> <tr> <th>Code</th> <th>Description</th> <th>Qty</th> <th>UOM</th> </tr> </thead> <tbody> <tr> <td>0H7820A0</td> <td>PLUS WASHING SY SUPPORT WITH STEAM VALVE</td> <td>1</td> <td>PZ</td> </tr> <tr> <td>EL1422A1</td> <td>1 WAY SOLENOID VALVE + D8-D10 REDUCTION</td> <td>1</td> <td>PZ</td> </tr> <tr> <td>EL1426A0</td> <td>H2O UL SOLENOID JG D8-PIPE HOLDER</td> <td>1</td> <td>PZ</td> </tr> <tr> <td>EL1426B0</td> <td></td> <td>1</td> <td>PZ</td> </tr> <tr> <td>EL1437A0</td> <td>H2O SOLENOID JG D6 UL CHECK VALVE</td> <td>1</td> <td>PZ</td> </tr> <tr> <td>GN1526A0</td> <td>INT. D.=6.9 TH=1.8 O-RING</td> <td>1</td> <td>PZ</td> </tr> <tr> <td>RC1019A0</td> <td>D=10 ELASTIC CLAMP</td> <td>12</td> <td>PZ</td> </tr> <tr> <td>RC1130A0</td> <td>130X2,6 CLAM</td> <td>1</td> <td>PZ</td> </tr> </tbody> </table>	Code	Description	Qty	UOM	0H7820A0	PLUS WASHING SY SUPPORT WITH STEAM VALVE	1	PZ	EL1422A1	1 WAY SOLENOID VALVE + D8-D10 REDUCTION	1	PZ	EL1426A0	H2O UL SOLENOID JG D8-PIPE HOLDER	1	PZ	EL1426B0		1	PZ	EL1437A0	H2O SOLENOID JG D6 UL CHECK VALVE	1	PZ	GN1526A0	INT. D.=6.9 TH=1.8 O-RING	1	PZ	RC1019A0	D=10 ELASTIC CLAMP	12	PZ	RC1130A0	130X2,6 CLAM	1	PZ							
Code	Description	Qty	UOM																																										
0H7820A0	PLUS WASHING SY SUPPORT WITH STEAM VALVE	1	PZ																																										
EL1422A1	1 WAY SOLENOID VALVE + D8-D10 REDUCTION	1	PZ																																										
EL1426A0	H2O UL SOLENOID JG D8-PIPE HOLDER	1	PZ																																										
EL1426B0		1	PZ																																										
EL1437A0	H2O SOLENOID JG D6 UL CHECK VALVE	1	PZ																																										
GN1526A0	INT. D.=6.9 TH=1.8 O-RING	1	PZ																																										
RC1019A0	D=10 ELASTIC CLAMP	12	PZ																																										
RC1130A0	130X2,6 CLAM	1	PZ																																										

COMPONENT			SPARE PART																																																		
Code	Description	Image	Code	Description	Components list																																																
VL1019A	VIBRATION PUMP		KVL1104A	USA 1 ROTOR ARM PLUS CLEANING SYSTEM KIT	<table border="1"> <thead> <tr> <th>Code</th> <th>Description</th> <th>Qty</th> <th>UOM</th> </tr> </thead> <tbody> <tr> <td>RC1242A0</td> <td>D=10 CLOSED CAP</td> <td>2</td> <td>PZ</td> </tr> <tr> <td>RC1356A0</td> <td>STRAIGHT THREADED FEMALE END 8X1/4" BSP</td> <td>1</td> <td>PZ</td> </tr> <tr> <td>TB2820A0</td> <td>PIPE EPDM FOR WASHING SYSTEM</td> <td>1.410</td> <td>M</td> </tr> <tr> <td>VI1220A1</td> <td>4,2X12 TCB SELF-TAPPIN G SCREW</td> <td>3</td> <td>PZ</td> </tr> <tr> <td>VL1019A0</td> <td>VIBRATION PUMP</td> <td>1</td> <td>PZ</td> </tr> <tr> <td>VL1064A0</td> <td>WASHING SYSTEM OUTLETS DISTRIBUTOR</td> <td>1</td> <td>PZ</td> </tr> <tr> <td>VL1065A1</td> <td>1/4 MALE N.O. PRESSURE SWITCH</td> <td>1</td> <td>PZ</td> </tr> <tr> <td>VL1067A0</td> <td>WASHING SYSTEM INLETS DISTRIBUTOR</td> <td>1</td> <td>PZ</td> </tr> <tr> <td>VL1102A1</td> <td>DETERGENT LINE FILTER + BARBED VNR 6 MM</td> <td>1</td> <td>PZ</td> </tr> <tr> <td>VL1128A0</td> <td>BARBED CHECK VALVE D6</td> <td>1</td> <td>PZ</td> </tr> <tr> <td>VM2172A0</td> <td>PUMP LOCKING CLIP</td> <td>1</td> <td>PZ</td> </tr> </tbody> </table>	Code	Description	Qty	UOM	RC1242A0	D=10 CLOSED CAP	2	PZ	RC1356A0	STRAIGHT THREADED FEMALE END 8X1/4" BSP	1	PZ	TB2820A0	PIPE EPDM FOR WASHING SYSTEM	1.410	M	VI1220A1	4,2X12 TCB SELF-TAPPIN G SCREW	3	PZ	VL1019A0	VIBRATION PUMP	1	PZ	VL1064A0	WASHING SYSTEM OUTLETS DISTRIBUTOR	1	PZ	VL1065A1	1/4 MALE N.O. PRESSURE SWITCH	1	PZ	VL1067A0	WASHING SYSTEM INLETS DISTRIBUTOR	1	PZ	VL1102A1	DETERGENT LINE FILTER + BARBED VNR 6 MM	1	PZ	VL1128A0	BARBED CHECK VALVE D6	1	PZ	VM2172A0	PUMP LOCKING CLIP	1	PZ
			Code	Description	Qty	UOM																																															
RC1242A0	D=10 CLOSED CAP	2	PZ																																																		
RC1356A0	STRAIGHT THREADED FEMALE END 8X1/4" BSP	1	PZ																																																		
TB2820A0	PIPE EPDM FOR WASHING SYSTEM	1.410	M																																																		
VI1220A1	4,2X12 TCB SELF-TAPPIN G SCREW	3	PZ																																																		
VL1019A0	VIBRATION PUMP	1	PZ																																																		
VL1064A0	WASHING SYSTEM OUTLETS DISTRIBUTOR	1	PZ																																																		
VL1065A1	1/4 MALE N.O. PRESSURE SWITCH	1	PZ																																																		
VL1067A0	WASHING SYSTEM INLETS DISTRIBUTOR	1	PZ																																																		
VL1102A1	DETERGENT LINE FILTER + BARBED VNR 6 MM	1	PZ																																																		
VL1128A0	BARBED CHECK VALVE D6	1	PZ																																																		
VM2172A0	PUMP LOCKING CLIP	1	PZ																																																		
KVL1103A	EUR 2 ROTOR ARMS PLUS CLEANING SYSTEM KIT	<table border="1"> <thead> <tr> <th>Code</th> <th>Description</th> <th>Qty</th> <th>UOM</th> </tr> </thead> <tbody> <tr> <td>0H7820A0</td> <td>PLUS WASHING SY SUPPORT WITH STEAM VALVE</td> <td>1</td> <td>PZ</td> </tr> <tr> <td>EL1252A1</td> <td>1 WAY WATER VALVE + J.G. CONNECTION</td> <td>1</td> <td>PZ</td> </tr> <tr> <td>EL1424A0</td> <td>D8 CONNECTION WATER SOLENOID VALVE</td> <td>2</td> <td>PZ</td> </tr> <tr> <td>EL1424B0</td> <td></td> <td>2</td> <td>PZ</td> </tr> <tr> <td>EL1436A0</td> <td>H2O SOLENOID JG D8 CHECK VALVE</td> <td>1</td> <td>PZ</td> </tr> <tr> <td>EL1436B0</td> <td></td> <td>1</td> <td>PZ</td> </tr> </tbody> </table>	Code	Description	Qty	UOM	0H7820A0	PLUS WASHING SY SUPPORT WITH STEAM VALVE	1	PZ	EL1252A1	1 WAY WATER VALVE + J.G. CONNECTION	1	PZ	EL1424A0	D8 CONNECTION WATER SOLENOID VALVE	2	PZ	EL1424B0		2	PZ	EL1436A0	H2O SOLENOID JG D8 CHECK VALVE	1	PZ	EL1436B0		1	PZ																							
Code	Description	Qty	UOM																																																		
0H7820A0	PLUS WASHING SY SUPPORT WITH STEAM VALVE	1	PZ																																																		
EL1252A1	1 WAY WATER VALVE + J.G. CONNECTION	1	PZ																																																		
EL1424A0	D8 CONNECTION WATER SOLENOID VALVE	2	PZ																																																		
EL1424B0		2	PZ																																																		
EL1436A0	H2O SOLENOID JG D8 CHECK VALVE	1	PZ																																																		
EL1436B0		1	PZ																																																		

COMPONENT			SPARE PART																																																																																	
Code	Description	Image	Code	Description	Components list																																																																															
VL1019A	VIBRATION PUMP		KVL1103A	EUR 2 ROTOR ARMS PLUS CLEANING SYSTEM KIT	<table border="1"> <thead> <tr> <th>Code</th> <th>Description</th> <th>Qty</th> <th>UOM</th> </tr> </thead> <tbody> <tr> <td>GN1526A0</td> <td>INT. D.=6.9 TH=1.8 O-RIN</td> <td>1</td> <td>PZ</td> </tr> <tr> <td>RC1019A0</td> <td>D=10 ELASTIC CLAMP</td> <td>12</td> <td>PZ</td> </tr> <tr> <td>RC1130A0</td> <td>130X2,6 CLAM</td> <td>1</td> <td>PZ</td> </tr> <tr> <td>RC1242A0</td> <td>D=10 CLOSED CAP</td> <td>2</td> <td>PZ</td> </tr> <tr> <td>RC1356A0</td> <td>STRAIGHT THREADED FEMALE END 8X1/4" BSP</td> <td>1</td> <td>PZ</td> </tr> <tr> <td>TB2820A0</td> <td>PIPE EPDM FOR WASHING SYSTEM</td> <td>1.410</td> <td>M</td> </tr> <tr> <td>VI1220A1</td> <td>4,2X12 TCB SELF-TAPPIN G SCREW</td> <td>3</td> <td>PZ</td> </tr> <tr> <td>VL1019A0</td> <td>VIBRATION PUMP</td> <td>1</td> <td>PZ</td> </tr> <tr> <td>VL1065A1</td> <td>1/4 MALE N.O. PRESSURE SWITCH</td> <td>1</td> <td>PZ</td> </tr> <tr> <td>VL1067A0</td> <td>WASHING SYSTEM INLETS DISTRIBUTOR</td> <td>1</td> <td>PZ</td> </tr> <tr> <td>VL1092A0</td> <td>WASHING SYSTEM OUTLET DOUBLE DISTRIBUTOR</td> <td>1</td> <td>PZ</td> </tr> <tr> <td>VL1102A1</td> <td>DETERGENT LINE FILTER + BARBED VNR 6 MM</td> <td>1</td> <td>PZ</td> </tr> <tr> <td>VL1128A0</td> <td>BARBED CHECK VALVE D6</td> <td>1</td> <td>PZ</td> </tr> <tr> <td>VM2172A0</td> <td>PUMP LOCKING CLIP</td> <td>1</td> <td>PZ</td> </tr> </tbody> </table>	Code	Description	Qty	UOM	GN1526A0	INT. D.=6.9 TH=1.8 O-RIN	1	PZ	RC1019A0	D=10 ELASTIC CLAMP	12	PZ	RC1130A0	130X2,6 CLAM	1	PZ	RC1242A0	D=10 CLOSED CAP	2	PZ	RC1356A0	STRAIGHT THREADED FEMALE END 8X1/4" BSP	1	PZ	TB2820A0	PIPE EPDM FOR WASHING SYSTEM	1.410	M	VI1220A1	4,2X12 TCB SELF-TAPPIN G SCREW	3	PZ	VL1019A0	VIBRATION PUMP	1	PZ	VL1065A1	1/4 MALE N.O. PRESSURE SWITCH	1	PZ	VL1067A0	WASHING SYSTEM INLETS DISTRIBUTOR	1	PZ	VL1092A0	WASHING SYSTEM OUTLET DOUBLE DISTRIBUTOR	1	PZ	VL1102A1	DETERGENT LINE FILTER + BARBED VNR 6 MM	1	PZ	VL1128A0	BARBED CHECK VALVE D6	1	PZ	VM2172A0	PUMP LOCKING CLIP	1	PZ	KVL1101A	EUR 1 ROTOR ARM PLUS CLEANING SYSTEM KIT	<table border="1"> <thead> <tr> <th>Code</th> <th>Description</th> <th>Qty</th> <th>UOM</th> </tr> </thead> <tbody> <tr> <td>0H7820A0</td> <td>PLUS WASHING SY SUPPORT WITH STEAM VALVE</td> <td>1</td> <td>PZ</td> </tr> <tr> <td>EL1252A1</td> <td>1 WAY WATER VALVE + J.G. CONNECTION</td> <td>1</td> <td>PZ</td> </tr> <tr> <td>EL1424A0</td> <td>D8 CONNECTION WATER SOLENOID VALVE</td> <td>1</td> <td>PZ</td> </tr> </tbody> </table>	Code	Description	Qty	UOM	0H7820A0	PLUS WASHING SY SUPPORT WITH STEAM VALVE	1	PZ	EL1252A1	1 WAY WATER VALVE + J.G. CONNECTION	1	PZ	EL1424A0	D8 CONNECTION WATER SOLENOID VALVE	1	PZ
			Code	Description	Qty	UOM																																																																														
GN1526A0	INT. D.=6.9 TH=1.8 O-RIN	1	PZ																																																																																	
RC1019A0	D=10 ELASTIC CLAMP	12	PZ																																																																																	
RC1130A0	130X2,6 CLAM	1	PZ																																																																																	
RC1242A0	D=10 CLOSED CAP	2	PZ																																																																																	
RC1356A0	STRAIGHT THREADED FEMALE END 8X1/4" BSP	1	PZ																																																																																	
TB2820A0	PIPE EPDM FOR WASHING SYSTEM	1.410	M																																																																																	
VI1220A1	4,2X12 TCB SELF-TAPPIN G SCREW	3	PZ																																																																																	
VL1019A0	VIBRATION PUMP	1	PZ																																																																																	
VL1065A1	1/4 MALE N.O. PRESSURE SWITCH	1	PZ																																																																																	
VL1067A0	WASHING SYSTEM INLETS DISTRIBUTOR	1	PZ																																																																																	
VL1092A0	WASHING SYSTEM OUTLET DOUBLE DISTRIBUTOR	1	PZ																																																																																	
VL1102A1	DETERGENT LINE FILTER + BARBED VNR 6 MM	1	PZ																																																																																	
VL1128A0	BARBED CHECK VALVE D6	1	PZ																																																																																	
VM2172A0	PUMP LOCKING CLIP	1	PZ																																																																																	
Code	Description	Qty	UOM																																																																																	
0H7820A0	PLUS WASHING SY SUPPORT WITH STEAM VALVE	1	PZ																																																																																	
EL1252A1	1 WAY WATER VALVE + J.G. CONNECTION	1	PZ																																																																																	
EL1424A0	D8 CONNECTION WATER SOLENOID VALVE	1	PZ																																																																																	





COMPONENT			SPARE PART																																																																																					
Code	Description	Image	Code	Description	Components list																																																																																			
VL1019A	VIBRATION PUMP		KVL1101A	EUR 1 ROTOR ARM PLUS CLEANING SYSTEM KIT	<table border="1"> <thead> <tr> <th>Code</th> <th>Description</th> <th>Qty</th> <th>UOM</th> </tr> </thead> <tbody> <tr> <td>EL1424B0</td> <td></td> <td>1</td> <td>PZ</td> </tr> <tr> <td>EL1436A0</td> <td>H2O SOLENOID JG D8 CHECK VALVE</td> <td>1</td> <td>PZ</td> </tr> <tr> <td>EL1436B0</td> <td></td> <td>1</td> <td>PZ</td> </tr> <tr> <td>GN1526A0</td> <td>INT. D.=6.9 TH=1.8 O-RIN</td> <td>1</td> <td>PZ</td> </tr> <tr> <td>RC1019A0</td> <td>D=10 ELASTIC CLAMP</td> <td>12</td> <td>PZ</td> </tr> <tr> <td>RC1130A0</td> <td>130X2,6 CLAM</td> <td>1</td> <td>PZ</td> </tr> <tr> <td>RC1242A0</td> <td>D=10 CLOSED CAP</td> <td>2</td> <td>PZ</td> </tr> <tr> <td>RC1356A0</td> <td>STRAIGHT THREADED FEMALE END 8X1/4" BSP</td> <td>1</td> <td>PZ</td> </tr> <tr> <td>TB2820A0</td> <td>PIPE EPDM FOR WASHING SYSTEM</td> <td>1.410</td> <td>M</td> </tr> <tr> <td>VI1220A1</td> <td>4,2X12 TCB SELF-TAPPIN G SCREW</td> <td>3</td> <td>PZ</td> </tr> <tr> <td>VL1019A0</td> <td>VIBRATION PUMP</td> <td>1</td> <td>PZ</td> </tr> <tr> <td>VL1064A0</td> <td>WASHING SYSTEM OUTLETS DISTRIBUTOR</td> <td>1</td> <td>PZ</td> </tr> <tr> <td>VL1065A1</td> <td>1/4 MALE N.O. PRESSURE SWITCH</td> <td>1</td> <td>PZ</td> </tr> <tr> <td>VL1067A0</td> <td>WASHING SYSTEM INLETS DISTRIBUTOR</td> <td>1</td> <td>PZ</td> </tr> <tr> <td>VL1102A1</td> <td>DETERGENT LINE FILTER + BARBED VNR 6 MM</td> <td>1</td> <td>PZ</td> </tr> <tr> <td>VL1128A0</td> <td>BARBED CHECK VALVE D6</td> <td>1</td> <td>PZ</td> </tr> <tr> <td>VM2172A0</td> <td>PUMP LOCKING CLIP</td> <td>1</td> <td>PZ</td> </tr> </tbody> </table>	Code	Description	Qty	UOM	EL1424B0		1	PZ	EL1436A0	H2O SOLENOID JG D8 CHECK VALVE	1	PZ	EL1436B0		1	PZ	GN1526A0	INT. D.=6.9 TH=1.8 O-RIN	1	PZ	RC1019A0	D=10 ELASTIC CLAMP	12	PZ	RC1130A0	130X2,6 CLAM	1	PZ	RC1242A0	D=10 CLOSED CAP	2	PZ	RC1356A0	STRAIGHT THREADED FEMALE END 8X1/4" BSP	1	PZ	TB2820A0	PIPE EPDM FOR WASHING SYSTEM	1.410	M	VI1220A1	4,2X12 TCB SELF-TAPPIN G SCREW	3	PZ	VL1019A0	VIBRATION PUMP	1	PZ	VL1064A0	WASHING SYSTEM OUTLETS DISTRIBUTOR	1	PZ	VL1065A1	1/4 MALE N.O. PRESSURE SWITCH	1	PZ	VL1067A0	WASHING SYSTEM INLETS DISTRIBUTOR	1	PZ	VL1102A1	DETERGENT LINE FILTER + BARBED VNR 6 MM	1	PZ	VL1128A0	BARBED CHECK VALVE D6	1	PZ	VM2172A0	PUMP LOCKING CLIP	1	PZ	KVL1094A	0311 EUR CLEANING SYSTEM KIT	<table border="1"> <thead> <tr> <th>Code</th> <th>Description</th> <th>Qty</th> <th>UOM</th> </tr> </thead> <tbody> <tr> <td>0H7494B0</td> <td>ONE-03 WASHING SYST HOLDING PLATE</td> <td>1</td> <td>PZ</td> </tr> </tbody> </table>	Code	Description	Qty	UOM	0H7494B0	ONE-03 WASHING SYST HOLDING PLATE	1	PZ
			Code	Description	Qty	UOM																																																																																		
EL1424B0		1	PZ																																																																																					
EL1436A0	H2O SOLENOID JG D8 CHECK VALVE	1	PZ																																																																																					
EL1436B0		1	PZ																																																																																					
GN1526A0	INT. D.=6.9 TH=1.8 O-RIN	1	PZ																																																																																					
RC1019A0	D=10 ELASTIC CLAMP	12	PZ																																																																																					
RC1130A0	130X2,6 CLAM	1	PZ																																																																																					
RC1242A0	D=10 CLOSED CAP	2	PZ																																																																																					
RC1356A0	STRAIGHT THREADED FEMALE END 8X1/4" BSP	1	PZ																																																																																					
TB2820A0	PIPE EPDM FOR WASHING SYSTEM	1.410	M																																																																																					
VI1220A1	4,2X12 TCB SELF-TAPPIN G SCREW	3	PZ																																																																																					
VL1019A0	VIBRATION PUMP	1	PZ																																																																																					
VL1064A0	WASHING SYSTEM OUTLETS DISTRIBUTOR	1	PZ																																																																																					
VL1065A1	1/4 MALE N.O. PRESSURE SWITCH	1	PZ																																																																																					
VL1067A0	WASHING SYSTEM INLETS DISTRIBUTOR	1	PZ																																																																																					
VL1102A1	DETERGENT LINE FILTER + BARBED VNR 6 MM	1	PZ																																																																																					
VL1128A0	BARBED CHECK VALVE D6	1	PZ																																																																																					
VM2172A0	PUMP LOCKING CLIP	1	PZ																																																																																					
Code	Description	Qty	UOM																																																																																					
0H7494B0	ONE-03 WASHING SYST HOLDING PLATE	1	PZ																																																																																					

COMPONENT			SPARE PART																																																						
Code	Description	Image	Code	Description	Components list																																																				
VL1019A	VIBRATION PUMP		KVL1094A	0311 EUR CLEANING SYSTEM KIT	<table border="1"> <thead> <tr> <th>Code</th> <th>Description</th> <th>Qty</th> <th>UOM</th> </tr> </thead> <tbody> <tr> <td>EL1436A0</td> <td>H2O SOLENOID JG D8 CHECK VALVE</td> <td>1</td> <td>PZ</td> </tr> <tr> <td>EL1436B0</td> <td></td> <td>1</td> <td>PZ</td> </tr> <tr> <td>GN1526A0</td> <td>INT. D.=6.9 TH=1.8 O-RIN</td> <td>1</td> <td>PZ</td> </tr> <tr> <td>RC1242A0</td> <td>D=10 CLOSED CAP</td> <td>2</td> <td>PZ</td> </tr> <tr> <td>TB2820A0</td> <td>PIPE EPDM FOR WASHING SYSTEM</td> <td>1.420</td> <td>M</td> </tr> <tr> <td>VI1220A1</td> <td>4,2X12 TCB SELF-TAPPIN G SCREW</td> <td>1</td> <td>PZ</td> </tr> <tr> <td>VL1019A0</td> <td>VIBRATION PUMP</td> <td>1</td> <td>PZ</td> </tr> <tr> <td>VL1053B0</td> <td>ONE WASHING SYS EXT DISTRIBUTOR</td> <td>1</td> <td>PZ</td> </tr> <tr> <td>VL1054B0</td> <td>ONE WASHING SYS INLET DISTRIBUTOR</td> <td>1</td> <td>PZ</td> </tr> <tr> <td>VL1102A1</td> <td>DETERGENT LINE FILTER + BARBED VNR 6 MM</td> <td>1</td> <td>PZ</td> </tr> <tr> <td>VL1128A0</td> <td>BARBED CHECK VALVE D6</td> <td>1</td> <td>PZ</td> </tr> <tr> <td>VM2172A0</td> <td>PUMP LOCKING CLIP</td> <td>1</td> <td>PZ</td> </tr> </tbody> </table>	Code	Description	Qty	UOM	EL1436A0	H2O SOLENOID JG D8 CHECK VALVE	1	PZ	EL1436B0		1	PZ	GN1526A0	INT. D.=6.9 TH=1.8 O-RIN	1	PZ	RC1242A0	D=10 CLOSED CAP	2	PZ	TB2820A0	PIPE EPDM FOR WASHING SYSTEM	1.420	M	VI1220A1	4,2X12 TCB SELF-TAPPIN G SCREW	1	PZ	VL1019A0	VIBRATION PUMP	1	PZ	VL1053B0	ONE WASHING SYS EXT DISTRIBUTOR	1	PZ	VL1054B0	ONE WASHING SYS INLET DISTRIBUTOR	1	PZ	VL1102A1	DETERGENT LINE FILTER + BARBED VNR 6 MM	1	PZ	VL1128A0	BARBED CHECK VALVE D6	1	PZ	VM2172A0	PUMP LOCKING CLIP	1	PZ
			Code	Description	Qty	UOM																																																			
EL1436A0	H2O SOLENOID JG D8 CHECK VALVE	1	PZ																																																						
EL1436B0		1	PZ																																																						
GN1526A0	INT. D.=6.9 TH=1.8 O-RIN	1	PZ																																																						
RC1242A0	D=10 CLOSED CAP	2	PZ																																																						
TB2820A0	PIPE EPDM FOR WASHING SYSTEM	1.420	M																																																						
VI1220A1	4,2X12 TCB SELF-TAPPIN G SCREW	1	PZ																																																						
VL1019A0	VIBRATION PUMP	1	PZ																																																						
VL1053B0	ONE WASHING SYS EXT DISTRIBUTOR	1	PZ																																																						
VL1054B0	ONE WASHING SYS INLET DISTRIBUTOR	1	PZ																																																						
VL1102A1	DETERGENT LINE FILTER + BARBED VNR 6 MM	1	PZ																																																						
VL1128A0	BARBED CHECK VALVE D6	1	PZ																																																						
VM2172A0	PUMP LOCKING CLIP	1	PZ																																																						
KVL1092A	EUR 2 ROTOR ARMS PLUS CHEMICAL PUMP KIT	<table border="1"> <thead> <tr> <th>Code</th> <th>Description</th> <th>Qty</th> <th>UOM</th> </tr> </thead> <tbody> <tr> <td>GN1526A0</td> <td>INT. D.=6.9 TH=1.8 O-RIN</td> <td>1</td> <td>PZ</td> </tr> <tr> <td>RC1019A0</td> <td>D=10 ELASTIC CLAMP</td> <td>6</td> <td>PZ</td> </tr> <tr> <td>RC1130A0</td> <td>130X2,6 CLAM</td> <td>1</td> <td>PZ</td> </tr> <tr> <td>RC1242A0</td> <td>D=10 CLOSED CAP</td> <td>2</td> <td>PZ</td> </tr> <tr> <td>TB2820A0</td> <td>PIPE EPDM FOR WASHING SYSTEM</td> <td>0.120</td> <td>M</td> </tr> <tr> <td>VL1019A0</td> <td>VIBRATION PUMP</td> <td>1</td> <td>PZ</td> </tr> <tr> <td>VL1067A0</td> <td>WASHING SYSTEM INLETS DISTRIBUTOR</td> <td>1</td> <td>PZ</td> </tr> </tbody> </table>	Code	Description	Qty	UOM	GN1526A0	INT. D.=6.9 TH=1.8 O-RIN	1	PZ	RC1019A0	D=10 ELASTIC CLAMP	6	PZ	RC1130A0	130X2,6 CLAM	1	PZ	RC1242A0	D=10 CLOSED CAP	2	PZ	TB2820A0	PIPE EPDM FOR WASHING SYSTEM	0.120	M	VL1019A0	VIBRATION PUMP	1	PZ	VL1067A0	WASHING SYSTEM INLETS DISTRIBUTOR	1	PZ																							
Code	Description	Qty	UOM																																																						
GN1526A0	INT. D.=6.9 TH=1.8 O-RIN	1	PZ																																																						
RC1019A0	D=10 ELASTIC CLAMP	6	PZ																																																						
RC1130A0	130X2,6 CLAM	1	PZ																																																						
RC1242A0	D=10 CLOSED CAP	2	PZ																																																						
TB2820A0	PIPE EPDM FOR WASHING SYSTEM	0.120	M																																																						
VL1019A0	VIBRATION PUMP	1	PZ																																																						
VL1067A0	WASHING SYSTEM INLETS DISTRIBUTOR	1	PZ																																																						





COMPONENT			SPARE PART																																											
Code	Description	Image	Code	Description	Components list																																									
VL1019A	VIBRATION PUMP		KVL1092A	EUR 2 ROTOR ARMS PLUS CHEMICAL PUMP KIT	<table border="1"> <thead> <tr> <th>Code</th> <th>Description</th> <th>Qty</th> <th>UOM</th> </tr> </thead> <tbody> <tr> <td>VL1092A0</td> <td>WASHING SYSTEM OUTLET DOUBLE DISTRIBUTOR</td> <td>1</td> <td>PZ</td> </tr> <tr> <td>VL1128A0</td> <td>BARBED CHECK VALVE D6</td> <td>1</td> <td>PZ</td> </tr> <tr> <td>VM2172A0</td> <td>PUMP LOCKING CLIP</td> <td>1</td> <td>PZ</td> </tr> </tbody> </table>	Code	Description	Qty	UOM	VL1092A0	WASHING SYSTEM OUTLET DOUBLE DISTRIBUTOR	1	PZ	VL1128A0	BARBED CHECK VALVE D6	1	PZ	VM2172A0	PUMP LOCKING CLIP	1	PZ																									
			Code	Description	Qty	UOM																																								
			VL1092A0	WASHING SYSTEM OUTLET DOUBLE DISTRIBUTOR	1	PZ																																								
VL1128A0	BARBED CHECK VALVE D6	1	PZ																																											
VM2172A0	PUMP LOCKING CLIP	1	PZ																																											
KVL1073A	EUR 1 ROTOR ARM PLUS CHEMICAL PUMP KIT	<table border="1"> <thead> <tr> <th>Code</th> <th>Description</th> <th>Qty</th> <th>UOM</th> </tr> </thead> <tbody> <tr> <td>GN1526A0</td> <td>INT. D.=6.9 TH=1.8 O-RIN</td> <td>1</td> <td>PZ</td> </tr> <tr> <td>RC1019A0</td> <td>D=10 ELASTIC CLAMP</td> <td>6</td> <td>PZ</td> </tr> <tr> <td>RC1130A0</td> <td>130X2,6 CLAM</td> <td>1</td> <td>PZ</td> </tr> <tr> <td>RC1242A0</td> <td>D=10 CLOSED CAP</td> <td>2</td> <td>PZ</td> </tr> <tr> <td>TB2820A0</td> <td>PIPE EPDM FOR WASHING SYSTEM</td> <td>0.120</td> <td>M</td> </tr> <tr> <td>VL1019A0</td> <td>VIBRATION PUMP</td> <td>1</td> <td>PZ</td> </tr> <tr> <td>VL1064A0</td> <td>WASHING SYSTEM OUTLETS DISTRIBUTOR</td> <td>1</td> <td>PZ</td> </tr> <tr> <td>VL1067A0</td> <td>WASHING SYSTEM INLETS DISTRIBUTOR</td> <td>1</td> <td>PZ</td> </tr> <tr> <td>VL1128A0</td> <td>BARBED CHECK VALVE D6</td> <td>1</td> <td>PZ</td> </tr> <tr> <td>VM2172A0</td> <td>PUMP LOCKING CLIP</td> <td>1</td> <td>PZ</td> </tr> </tbody> </table>	Code	Description	Qty	UOM	GN1526A0	INT. D.=6.9 TH=1.8 O-RIN	1	PZ	RC1019A0	D=10 ELASTIC CLAMP	6	PZ	RC1130A0	130X2,6 CLAM	1	PZ	RC1242A0	D=10 CLOSED CAP	2	PZ	TB2820A0	PIPE EPDM FOR WASHING SYSTEM	0.120	M	VL1019A0	VIBRATION PUMP	1	PZ	VL1064A0	WASHING SYSTEM OUTLETS DISTRIBUTOR	1	PZ	VL1067A0	WASHING SYSTEM INLETS DISTRIBUTOR	1	PZ	VL1128A0	BARBED CHECK VALVE D6	1	PZ	VM2172A0	PUMP LOCKING CLIP	1	PZ
Code	Description	Qty	UOM																																											
GN1526A0	INT. D.=6.9 TH=1.8 O-RIN	1	PZ																																											
RC1019A0	D=10 ELASTIC CLAMP	6	PZ																																											
RC1130A0	130X2,6 CLAM	1	PZ																																											
RC1242A0	D=10 CLOSED CAP	2	PZ																																											
TB2820A0	PIPE EPDM FOR WASHING SYSTEM	0.120	M																																											
VL1019A0	VIBRATION PUMP	1	PZ																																											
VL1064A0	WASHING SYSTEM OUTLETS DISTRIBUTOR	1	PZ																																											
VL1067A0	WASHING SYSTEM INLETS DISTRIBUTOR	1	PZ																																											
VL1128A0	BARBED CHECK VALVE D6	1	PZ																																											
VM2172A0	PUMP LOCKING CLIP	1	PZ																																											
KVL1072A	ONE SERIES CHEMICAL PUMP KI	<table border="1"> <thead> <tr> <th>Code</th> <th>Description</th> <th>Qty</th> <th>UOM</th> </tr> </thead> <tbody> <tr> <td>GN1526A0</td> <td>INT. D.=6.9 TH=1.8 O-RIN</td> <td>1</td> <td>PZ</td> </tr> <tr> <td>RC1019A0</td> <td>D=10 ELASTIC CLAMP</td> <td>6</td> <td>PZ</td> </tr> <tr> <td>RC1242A0</td> <td>D=10 CLOSED CAP</td> <td>2</td> <td>PZ</td> </tr> <tr> <td>TB2820A0</td> <td>PIPE EPDM FOR WASHING SYSTEM</td> <td>0.120</td> <td>M</td> </tr> <tr> <td>VI1220A1</td> <td>4,2X12 TCB SELF-TAPPIN G SCREW</td> <td>1</td> <td>PZ</td> </tr> <tr> <td>VL1019A0</td> <td>VIBRATION PUMP</td> <td>1</td> <td>PZ</td> </tr> </tbody> </table>	Code	Description	Qty	UOM	GN1526A0	INT. D.=6.9 TH=1.8 O-RIN	1	PZ	RC1019A0	D=10 ELASTIC CLAMP	6	PZ	RC1242A0	D=10 CLOSED CAP	2	PZ	TB2820A0	PIPE EPDM FOR WASHING SYSTEM	0.120	M	VI1220A1	4,2X12 TCB SELF-TAPPIN G SCREW	1	PZ	VL1019A0	VIBRATION PUMP	1	PZ																
Code	Description	Qty	UOM																																											
GN1526A0	INT. D.=6.9 TH=1.8 O-RIN	1	PZ																																											
RC1019A0	D=10 ELASTIC CLAMP	6	PZ																																											
RC1242A0	D=10 CLOSED CAP	2	PZ																																											
TB2820A0	PIPE EPDM FOR WASHING SYSTEM	0.120	M																																											
VI1220A1	4,2X12 TCB SELF-TAPPIN G SCREW	1	PZ																																											
VL1019A0	VIBRATION PUMP	1	PZ																																											

COMPONENT			SPARE PART																																																											
Code	Description	Image	Code	Description	Components list																																																									
VL1019A	VIBRATION PUMP		KVL1072A	ONE SERIES CHEMICAL PUMP KI	<table border="1"> <thead> <tr> <th>Code</th> <th>Description</th> <th>Qty</th> <th>UOM</th> </tr> </thead> <tbody> <tr> <td>VL1053B0</td> <td>ONE WASHING SYS EXT DISTRIBUTOR</td> <td>1</td> <td>PZ</td> </tr> <tr> <td>VL1054B0</td> <td>ONE WASHING SYS INLET DISTRIBUTOR</td> <td>1</td> <td>PZ</td> </tr> <tr> <td>VL1128A0</td> <td>BARBED CHECK VALVE D6</td> <td>1</td> <td>PZ</td> </tr> <tr> <td>VM2172A0</td> <td>PUMP LOCKING CLIP</td> <td>1</td> <td>PZ</td> </tr> </tbody> </table>	Code	Description	Qty	UOM	VL1053B0	ONE WASHING SYS EXT DISTRIBUTOR	1	PZ	VL1054B0	ONE WASHING SYS INLET DISTRIBUTOR	1	PZ	VL1128A0	BARBED CHECK VALVE D6	1	PZ	VM2172A0	PUMP LOCKING CLIP	1	PZ																																					
			Code	Description	Qty	UOM																																																								
VL1053B0	ONE WASHING SYS EXT DISTRIBUTOR	1	PZ																																																											
VL1054B0	ONE WASHING SYS INLET DISTRIBUTOR	1	PZ																																																											
VL1128A0	BARBED CHECK VALVE D6	1	PZ																																																											
VM2172A0	PUMP LOCKING CLIP	1	PZ																																																											
KVL0001A	LM TOP CLEANING SYSTEM KIT	<table border="1"> <thead> <tr> <th>Code</th> <th>Description</th> <th>Qty</th> <th>UOM</th> </tr> </thead> <tbody> <tr> <td>0H1226B0</td> <td>LINEMISSTOP WASHING SYTEM CIRCUIT COVE</td> <td>1</td> <td>PZ</td> </tr> <tr> <td>GN1312A0</td> <td>RUBBER CABLE-PASSI NG DE=26 DI=15 SP=10</td> <td>1</td> <td>PZ</td> </tr> <tr> <td>GN1526A0</td> <td>INT. D.=6.9 TH=1.8 O-RIN</td> <td>1</td> <td>PZ</td> </tr> <tr> <td>RC1019A0</td> <td>D=10 ELASTIC CLAMP</td> <td>5</td> <td>PZ</td> </tr> <tr> <td>RC1242A0</td> <td>D=10 CLOSED CAP</td> <td>2</td> <td>PZ</td> </tr> <tr> <td>RC1381A0</td> <td>BIFILAR PIPE CLIP D10.7</td> <td>3</td> <td>PZ</td> </tr> <tr> <td>TB2343A0</td> <td>9X6 PVC TRANSPAREN T PIPE</td> <td>1.650</td> <td>M</td> </tr> <tr> <td>TB2820A0</td> <td>PIPE EPDM FOR WASHING SYSTEM</td> <td>0.990</td> <td>M</td> </tr> <tr> <td>VI1220A1</td> <td>4,2X12 TCB SELF-TAPPIN G SCREW</td> <td>1</td> <td>PZ</td> </tr> <tr> <td>VL1019A0</td> <td>VIBRATION PUMP</td> <td>1</td> <td>PZ</td> </tr> <tr> <td>VL1041C0</td> <td>DETERGENT CAP WITH Ø12 HOLE</td> <td>1</td> <td>PZ</td> </tr> <tr> <td>VL1047A1</td> <td>D6 PIPE HOLDER - D8 J.G. TERMINAL</td> <td>1</td> <td>PZ</td> </tr> <tr> <td>VL1053B0</td> <td>ONE WASHING SYS EXT DISTRIBUTOR</td> <td>1</td> <td>PZ</td> </tr> <tr> <td>VL1054B0</td> <td>ONE WASHING SYS INLET DISTRIBUTOR</td> <td>1</td> <td>PZ</td> </tr> </tbody> </table>	Code	Description	Qty	UOM	0H1226B0	LINEMISSTOP WASHING SYTEM CIRCUIT COVE	1	PZ	GN1312A0	RUBBER CABLE-PASSI NG DE=26 DI=15 SP=10	1	PZ	GN1526A0	INT. D.=6.9 TH=1.8 O-RIN	1	PZ	RC1019A0	D=10 ELASTIC CLAMP	5	PZ	RC1242A0	D=10 CLOSED CAP	2	PZ	RC1381A0	BIFILAR PIPE CLIP D10.7	3	PZ	TB2343A0	9X6 PVC TRANSPAREN T PIPE	1.650	M	TB2820A0	PIPE EPDM FOR WASHING SYSTEM	0.990	M	VI1220A1	4,2X12 TCB SELF-TAPPIN G SCREW	1	PZ	VL1019A0	VIBRATION PUMP	1	PZ	VL1041C0	DETERGENT CAP WITH Ø12 HOLE	1	PZ	VL1047A1	D6 PIPE HOLDER - D8 J.G. TERMINAL	1	PZ	VL1053B0	ONE WASHING SYS EXT DISTRIBUTOR	1	PZ	VL1054B0	ONE WASHING SYS INLET DISTRIBUTOR	1	PZ
Code	Description	Qty	UOM																																																											
0H1226B0	LINEMISSTOP WASHING SYTEM CIRCUIT COVE	1	PZ																																																											
GN1312A0	RUBBER CABLE-PASSI NG DE=26 DI=15 SP=10	1	PZ																																																											
GN1526A0	INT. D.=6.9 TH=1.8 O-RIN	1	PZ																																																											
RC1019A0	D=10 ELASTIC CLAMP	5	PZ																																																											
RC1242A0	D=10 CLOSED CAP	2	PZ																																																											
RC1381A0	BIFILAR PIPE CLIP D10.7	3	PZ																																																											
TB2343A0	9X6 PVC TRANSPAREN T PIPE	1.650	M																																																											
TB2820A0	PIPE EPDM FOR WASHING SYSTEM	0.990	M																																																											
VI1220A1	4,2X12 TCB SELF-TAPPIN G SCREW	1	PZ																																																											
VL1019A0	VIBRATION PUMP	1	PZ																																																											
VL1041C0	DETERGENT CAP WITH Ø12 HOLE	1	PZ																																																											
VL1047A1	D6 PIPE HOLDER - D8 J.G. TERMINAL	1	PZ																																																											
VL1053B0	ONE WASHING SYS EXT DISTRIBUTOR	1	PZ																																																											
VL1054B0	ONE WASHING SYS INLET DISTRIBUTOR	1	PZ																																																											

COMPONENT			SPARE PART																														
Code	Description	Image	Code	Description	Components list																												
VL1019A	VIBRATION PUMP		KVL0001A	LM TOP CLEANING SYSTEM KIT	<table border="1"> <thead> <tr> <th>Code</th> <th>Description</th> <th>Qty</th> <th>UOM</th> </tr> </thead> <tbody> <tr> <td>VL1061A0</td> <td>HOLD DOWN WEIGHT+NET FILTER+NON-RET. V.</td> <td>1</td> <td>PZ</td> </tr> <tr> <td>VL1128A0</td> <td>BARBED CHECK VALVE D6</td> <td>2</td> <td>PZ</td> </tr> <tr> <td>VM1066A0</td> <td>SADDLE CLIP FOR CABLES PASSING</td> <td>3</td> <td>PZ</td> </tr> <tr> <td>VM1088A0</td> <td>NYLON CLICK CLAMP D7.9-D9.2</td> <td>1</td> <td>PZ</td> </tr> <tr> <td>VM1605A0</td> <td>CLIP TWIST LOCK DIAM. 10,2-12,7 MM</td> <td>1</td> <td>PZ</td> </tr> <tr> <td>VM2172A0</td> <td>PUMP LOCKING CLIP</td> <td>1</td> <td>PZ</td> </tr> </tbody> </table>	Code	Description	Qty	UOM	VL1061A0	HOLD DOWN WEIGHT+NET FILTER+NON-RET. V.	1	PZ	VL1128A0	BARBED CHECK VALVE D6	2	PZ	VM1066A0	SADDLE CLIP FOR CABLES PASSING	3	PZ	VM1088A0	NYLON CLICK CLAMP D7.9-D9.2	1	PZ	VM1605A0	CLIP TWIST LOCK DIAM. 10,2-12,7 MM	1	PZ	VM2172A0	PUMP LOCKING CLIP	1	PZ
Code	Description	Qty	UOM																														
VL1061A0	HOLD DOWN WEIGHT+NET FILTER+NON-RET. V.	1	PZ																														
VL1128A0	BARBED CHECK VALVE D6	2	PZ																														
VM1066A0	SADDLE CLIP FOR CABLES PASSING	3	PZ																														
VM1088A0	NYLON CLICK CLAMP D7.9-D9.2	1	PZ																														
VM1605A0	CLIP TWIST LOCK DIAM. 10,2-12,7 MM	1	PZ																														
VM2172A0	PUMP LOCKING CLIP	1	PZ																														
VM2172A	PUMP LOCKING CLI		VM2172A0	PUMP LOCKING CLI																													
RC1019A	D=10 ELASTIC CLAM		KRC1019A	Ø10 ZINC PLATED ELASTIC CLAMP 15 PCS KIT	<table border="1"> <thead> <tr> <th>Code</th> <th>Description</th> <th>Qty</th> <th>UOM</th> </tr> </thead> <tbody> <tr> <td>RC1019A0</td> <td>D=10 ELASTIC CLAMP</td> <td>17</td> <td>PZ</td> </tr> </tbody> </table>	Code	Description	Qty	UOM	RC1019A0	D=10 ELASTIC CLAMP	17	PZ																				
Code	Description	Qty	UOM																														
RC1019A0	D=10 ELASTIC CLAMP	17	PZ																														
RC1356A	STRAIGHT THREADED FEMALE END 8X1/4" BSP		KRC1356A	STRAIGHT THREADED FEMALE END 8X1/4 BS	<table border="1"> <thead> <tr> <th>Code</th> <th>Description</th> <th>Qty</th> <th>UOM</th> </tr> </thead> <tbody> <tr> <td>RC1356A0</td> <td>STRAIGHT THREADED FEMALE END 8X1/4" BSP</td> <td>1</td> <td>PZ</td> </tr> </tbody> </table>	Code	Description	Qty	UOM	RC1356A0	STRAIGHT THREADED FEMALE END 8X1/4" BSP	1	PZ																				
Code	Description	Qty	UOM																														
RC1356A0	STRAIGHT THREADED FEMALE END 8X1/4" BSP	1	PZ																														

COMPONENT			SPARE PART																		
Code	Description	Image	Code	Description	Components list																
VL1065A	1/4 MALE N.O. PRESSURE SWITCH		KVL1065A	1/4 M N.O. CIL. PRESSURE SWITCH KIT	<table border="1"> <thead> <tr> <th>Code</th> <th>Description</th> <th>Qty</th> <th>UOM</th> </tr> </thead> <tbody> <tr> <td>VL1065A1</td> <td>1/4 MALE N.O. PRESSURE SWITCH</td> <td>1</td> <td>PZ</td> </tr> </tbody> </table>	Code	Description	Qty	UOM	VL1065A1	1/4 MALE N.O. PRESSURE SWITCH	1	PZ								
Code	Description	Qty	UOM																		
VL1065A1	1/4 MALE N.O. PRESSURE SWITCH	1	PZ																		
VL1081A	D6 BARBED NO RETURN VALVE		KVL1128A	D6 VNR BARBED VALVE KIT	<table border="1"> <thead> <tr> <th>Code</th> <th>Description</th> <th>Qty</th> <th>UOM</th> </tr> </thead> <tbody> <tr> <td>RC1019A0</td> <td>D=10 ELASTIC CLAMP</td> <td>4</td> <td>PZ</td> </tr> <tr> <td>TB2820A0</td> <td>PIPE EPDM FOR WASHING SYSTEM</td> <td>0.080</td> <td>M</td> </tr> <tr> <td>VL1128A0</td> <td>BARBED CHECK VALVE D6</td> <td>1</td> <td>PZ</td> </tr> </tbody> </table>	Code	Description	Qty	UOM	RC1019A0	D=10 ELASTIC CLAMP	4	PZ	TB2820A0	PIPE EPDM FOR WASHING SYSTEM	0.080	M	VL1128A0	BARBED CHECK VALVE D6	1	PZ
Code	Description	Qty	UOM																		
RC1019A0	D=10 ELASTIC CLAMP	4	PZ																		
TB2820A0	PIPE EPDM FOR WASHING SYSTEM	0.080	M																		
VL1128A0	BARBED CHECK VALVE D6	1	PZ																		
VL1083A	D=10 CONNECTION - D=6 PIPE FITTING		KVL1095A	STRAIGHT CONNECT-HOLDER D7-D10 10PCS KIT	<table border="1"> <thead> <tr> <th>Code</th> <th>Description</th> <th>Qty</th> <th>UOM</th> </tr> </thead> <tbody> <tr> <td>VL1095A0</td> <td>FITTING M-M RUBBER HOLDER D7,8-D10</td> <td>10</td> <td>PZ</td> </tr> </tbody> </table>	Code	Description	Qty	UOM	VL1095A0	FITTING M-M RUBBER HOLDER D7,8-D10	10	PZ								
Code	Description	Qty	UOM																		
VL1095A0	FITTING M-M RUBBER HOLDER D7,8-D10	10	PZ																		
VL1080A	DETERGENT FILTER		KVL1102A	DETERGENT FILTER + NRV KIT	<table border="1"> <thead> <tr> <th>Code</th> <th>Description</th> <th>Qty</th> <th>UOM</th> </tr> </thead> <tbody> <tr> <td>RC1019A0</td> <td>D=10 ELASTIC CLAMP</td> <td>5</td> <td>PZ</td> </tr> <tr> <td>TB2820A0</td> <td>PIPE EPDM FOR WASHING SYSTEM</td> <td>0.710</td> <td>M</td> </tr> <tr> <td>VL1102A1</td> <td>DETERGENT LINE FILTER + BARBED VNR 6 MM</td> <td>1</td> <td>PZ</td> </tr> </tbody> </table>	Code	Description	Qty	UOM	RC1019A0	D=10 ELASTIC CLAMP	5	PZ	TB2820A0	PIPE EPDM FOR WASHING SYSTEM	0.710	M	VL1102A1	DETERGENT LINE FILTER + BARBED VNR 6 MM	1	PZ
Code	Description	Qty	UOM																		
RC1019A0	D=10 ELASTIC CLAMP	5	PZ																		
TB2820A0	PIPE EPDM FOR WASHING SYSTEM	0.710	M																		
VL1102A1	DETERGENT LINE FILTER + BARBED VNR 6 MM	1	PZ																		
RC1242A	D=10 CLOSED CAP		KRC1242A	Ø10 CLOSED CONNECTION 20PCS KIT	<table border="1"> <thead> <tr> <th>Code</th> <th>Description</th> <th>Qty</th> <th>UOM</th> </tr> </thead> <tbody> <tr> <td>RC1242A0</td> <td>D=10 CLOSED CAP</td> <td>20</td> <td>PZ</td> </tr> </tbody> </table>	Code	Description	Qty	UOM	RC1242A0	D=10 CLOSED CAP	20	PZ								
Code	Description	Qty	UOM																		
RC1242A0	D=10 CLOSED CAP	20	PZ																		

COMPONENT			SPARE PART																																														
Code	Description	Image	Code	Description	Components list																																												
EL1424A	H2O UL SOLENOID JG D8-PIPE HOLDER		KEL1426A	WATER SOLENOID VALVE KIT JG D8	<table border="1"> <thead> <tr> <th>Code</th> <th>Description</th> <th>Qty</th> <th>UOM</th> </tr> </thead> <tbody> <tr> <td>EL1426A0</td> <td>H2O UL SOLENOID JG D8-PIPE HOLDER</td> <td>1</td> <td>PZ</td> </tr> </tbody> </table>	Code	Description	Qty	UOM	EL1426A0	H2O UL SOLENOID JG D8-PIPE HOLDER	1	PZ																																				
Code	Description	Qty	UOM																																														
EL1426A0	H2O UL SOLENOID JG D8-PIPE HOLDER	1	PZ																																														
EL1252A	1 WAY WATER VALVE + J.G. CONNECTION		KEL1252A	EL2 JG D8-D10 1 WAY SOLENOID VALVE KIT	<table border="1"> <thead> <tr> <th>Code</th> <th>Description</th> <th>Qty</th> <th>UOM</th> </tr> </thead> <tbody> <tr> <td>EL1252A1</td> <td>1 WAY WATER VALVE + J.G. CONNECTION</td> <td>1</td> <td>PZ</td> </tr> </tbody> </table>	Code	Description	Qty	UOM	EL1252A1	1 WAY WATER VALVE + J.G. CONNECTION	1	PZ																																				
Code	Description	Qty	UOM																																														
EL1252A1	1 WAY WATER VALVE + J.G. CONNECTION	1	PZ																																														
VL1092A	WASHING SYSTEM OUTLET DOUBLE DISTRIBUTOR		KVL1092A	EUR 2 ROTOR ARMS PLUS CHEMICAL PUMP KIT	<table border="1"> <thead> <tr> <th>Code</th> <th>Description</th> <th>Qty</th> <th>UOM</th> </tr> </thead> <tbody> <tr> <td>GN1526A0</td> <td>INT. D.=6.9 TH=1.8 O-RIN</td> <td>1</td> <td>PZ</td> </tr> <tr> <td>RC1019A0</td> <td>D=10 ELASTIC CLAMP</td> <td>6</td> <td>PZ</td> </tr> <tr> <td>RC1130A0</td> <td>130X2,6 CLAM</td> <td>1</td> <td>PZ</td> </tr> <tr> <td>RC1242A0</td> <td>D=10 CLOSED CAP</td> <td>2</td> <td>PZ</td> </tr> <tr> <td>TB2820A0</td> <td>PIPE EPDM FOR WASHING SYSTEM</td> <td>0.120</td> <td>M</td> </tr> <tr> <td>VL1019A0</td> <td>VIBRATION PUMP</td> <td>1</td> <td>PZ</td> </tr> <tr> <td>VL1067A0</td> <td>WASHING SYSTEM INLETS DISTRIBUTOR</td> <td>1</td> <td>PZ</td> </tr> <tr> <td>VL1092A0</td> <td>WASHING SYSTEM OUTLET DOUBLE DISTRIBUTOR</td> <td>1</td> <td>PZ</td> </tr> <tr> <td>VL1128A0</td> <td>BARBED CHECK VALVE D6</td> <td>1</td> <td>PZ</td> </tr> <tr> <td>VM2172A0</td> <td>PUMP LOCKING CLIP</td> <td>1</td> <td>PZ</td> </tr> </tbody> </table>	Code	Description	Qty	UOM	GN1526A0	INT. D.=6.9 TH=1.8 O-RIN	1	PZ	RC1019A0	D=10 ELASTIC CLAMP	6	PZ	RC1130A0	130X2,6 CLAM	1	PZ	RC1242A0	D=10 CLOSED CAP	2	PZ	TB2820A0	PIPE EPDM FOR WASHING SYSTEM	0.120	M	VL1019A0	VIBRATION PUMP	1	PZ	VL1067A0	WASHING SYSTEM INLETS DISTRIBUTOR	1	PZ	VL1092A0	WASHING SYSTEM OUTLET DOUBLE DISTRIBUTOR	1	PZ	VL1128A0	BARBED CHECK VALVE D6	1	PZ	VM2172A0	PUMP LOCKING CLIP	1	PZ
Code	Description	Qty	UOM																																														
GN1526A0	INT. D.=6.9 TH=1.8 O-RIN	1	PZ																																														
RC1019A0	D=10 ELASTIC CLAMP	6	PZ																																														
RC1130A0	130X2,6 CLAM	1	PZ																																														
RC1242A0	D=10 CLOSED CAP	2	PZ																																														
TB2820A0	PIPE EPDM FOR WASHING SYSTEM	0.120	M																																														
VL1019A0	VIBRATION PUMP	1	PZ																																														
VL1067A0	WASHING SYSTEM INLETS DISTRIBUTOR	1	PZ																																														
VL1092A0	WASHING SYSTEM OUTLET DOUBLE DISTRIBUTOR	1	PZ																																														
VL1128A0	BARBED CHECK VALVE D6	1	PZ																																														
VM2172A0	PUMP LOCKING CLIP	1	PZ																																														

COMPONENT			SPARE PART														
Code	Description	Image	Code	Description	Components list												
TB3005A	TB2820A-DET PLUS PIPE FOR FAN GUARD BACK		KTB1344A	TB2820A0 6X10 EPM PIPE 100M KIT	<table border="1"> <thead> <tr> <th>Code</th> <th>Description</th> <th>Qty</th> <th>UOM</th> </tr> </thead> <tbody> <tr> <td>TB2820A0</td> <td>PIPE EPDM FOR WASHING SYSTEM</td> <td>100</td> <td>M</td> </tr> <tr> <td>VM1059A1</td> <td>HEAT SHRINK FILM H800</td> <td>1.500</td> <td>M</td> </tr> </tbody> </table>	Code	Description	Qty	UOM	TB2820A0	PIPE EPDM FOR WASHING SYSTEM	100	M	VM1059A1	HEAT SHRINK FILM H800	1.500	M
			Code	Description	Qty	UOM											
TB2820A0	PIPE EPDM FOR WASHING SYSTEM	100	M														
VM1059A1	HEAT SHRINK FILM H800	1.500	M														
KTB1343A	TB2820A0 6X10 EPM PIPE 3M KIT	<table border="1"> <thead> <tr> <th>Code</th> <th>Description</th> <th>Qty</th> <th>UOM</th> </tr> </thead> <tbody> <tr> <td>TB2820A0</td> <td>PIPE EPDM FOR WASHING SYSTEM</td> <td>3</td> <td>M</td> </tr> </tbody> </table>	Code	Description	Qty	UOM	TB2820A0	PIPE EPDM FOR WASHING SYSTEM	3	M							
Code	Description	Qty	UOM														
TB2820A0	PIPE EPDM FOR WASHING SYSTEM	3	M														
TB3007A	TB2820A-DETERGE NT ONE COIL		KTB3007A	MIND.MAPS ONE DETERGENT PIPE COIL KIT	<table border="1"> <thead> <tr> <th>Code</th> <th>Description</th> <th>Qty</th> <th>UOM</th> </tr> </thead> <tbody> <tr> <td>TB2820A0</td> <td>PIPE EPDM FOR WASHING SYSTEM</td> <td>0.550</td> <td>M</td> </tr> </tbody> </table>	Code	Description	Qty	UOM	TB2820A0	PIPE EPDM FOR WASHING SYSTEM	0.550	M				
Code	Description	Qty	UOM														
TB2820A0	PIPE EPDM FOR WASHING SYSTEM	0.550	M														
EL1436A	H2O SOLENOID JG D8 CHECK VALVE		KEL1436B	D8 CONNECTION D6 SOLEN. VALVE KIT	<table border="1"> <thead> <tr> <th>Code</th> <th>Description</th> <th>Qty</th> <th>UOM</th> </tr> </thead> <tbody> <tr> <td>EL1436B0</td> <td></td> <td>1</td> <td>PZ</td> </tr> </tbody> </table>	Code	Description	Qty	UOM	EL1436B0		1	PZ				
Code	Description	Qty	UOM														
EL1436B0		1	PZ														
RC1408A	DOUBLE WIRE SPRING CLAMP D10.8 ZN		KRC1408A	4 PCS D10.8 DOUBLE WIRE SPRING CLAMP KIT	<table border="1"> <thead> <tr> <th>Code</th> <th>Description</th> <th>Qty</th> <th>UOM</th> </tr> </thead> <tbody> <tr> <td>RC1408A0</td> <td>DOUBLE WIRE SPRING CLAMP D10.8 ZN</td> <td>4</td> <td>PZ</td> </tr> </tbody> </table>	Code	Description	Qty	UOM	RC1408A0	DOUBLE WIRE SPRING CLAMP D10.8 ZN	4	PZ				
Code	Description	Qty	UOM														
RC1408A0	DOUBLE WIRE SPRING CLAMP D10.8 ZN	4	PZ														
TB3114A			TB3114A0														

COMPONENT			SPARE PART																																										
Code	Description	Image	Code	Description	Components list																																								
RC1243A	Ø10F-Ø10M ELBOW CONNECTION + JG END KIT		KVL1117A	EUR MM 2016+LMT FILTER+PRESS. RED. KIT	<table border="1"> <thead> <tr> <th>Code</th> <th>Description</th> <th>Qty</th> <th>UOM</th> </tr> </thead> <tbody> <tr> <td>0H7472A1</td> <td>DISTRIBUTOR SUPPORT PLATE</td> <td>1</td> <td>PZ</td> </tr> <tr> <td>RC1004A0</td> <td>Ø10-Ø8-8 Y CONNECTION</td> <td>1</td> <td>PZ</td> </tr> <tr> <td>RC1243A0</td> <td>Ø10F-Ø10M ELBOW CONNECTION + JG END KIT</td> <td>1</td> <td>PZ</td> </tr> <tr> <td>RC1372A0</td> <td>Ø10M-1/4 M CIL. STRAIGHT FITTING</td> <td>2</td> <td>PZ</td> </tr> <tr> <td>VI1220A1</td> <td>4,2X12 TCB SELF-TAPPIN G SCREW</td> <td>4</td> <td>PZ</td> </tr> <tr> <td>VL1014B1</td> <td>PRESSURE REDUCER WITH DISTRIBUTOR</td> <td>1</td> <td>PZ</td> </tr> <tr> <td>VL1034C0</td> <td>MESH WATER FILTER D10</td> <td>1</td> <td>PZ</td> </tr> <tr> <td>VL1062C0</td> <td>PRESSURE REDUCER-FILTER LOCKING FORK</td> <td>1</td> <td>PZ</td> </tr> <tr> <td>VM1054A0</td> <td>H7.8 PRESSURE REDUCER RING NUT</td> <td>1</td> <td>PZ</td> </tr> </tbody> </table>	Code	Description	Qty	UOM	0H7472A1	DISTRIBUTOR SUPPORT PLATE	1	PZ	RC1004A0	Ø10-Ø8-8 Y CONNECTION	1	PZ	RC1243A0	Ø10F-Ø10M ELBOW CONNECTION + JG END KIT	1	PZ	RC1372A0	Ø10M-1/4 M CIL. STRAIGHT FITTING	2	PZ	VI1220A1	4,2X12 TCB SELF-TAPPIN G SCREW	4	PZ	VL1014B1	PRESSURE REDUCER WITH DISTRIBUTOR	1	PZ	VL1034C0	MESH WATER FILTER D10	1	PZ	VL1062C0	PRESSURE REDUCER-FILTER LOCKING FORK	1	PZ	VM1054A0	H7.8 PRESSURE REDUCER RING NUT	1	PZ
					Code	Description	Qty	UOM																																					
0H7472A1	DISTRIBUTOR SUPPORT PLATE	1	PZ																																										
RC1004A0	Ø10-Ø8-8 Y CONNECTION	1	PZ																																										
RC1243A0	Ø10F-Ø10M ELBOW CONNECTION + JG END KIT	1	PZ																																										
RC1372A0	Ø10M-1/4 M CIL. STRAIGHT FITTING	2	PZ																																										
VI1220A1	4,2X12 TCB SELF-TAPPIN G SCREW	4	PZ																																										
VL1014B1	PRESSURE REDUCER WITH DISTRIBUTOR	1	PZ																																										
VL1034C0	MESH WATER FILTER D10	1	PZ																																										
VL1062C0	PRESSURE REDUCER-FILTER LOCKING FORK	1	PZ																																										
VM1054A0	H7.8 PRESSURE REDUCER RING NUT	1	PZ																																										
KRC1243A	Ø10F-Ø10M ELBOW CONN + JG END 10 PCS KIT	<table border="1"> <thead> <tr> <th>Code</th> <th>Description</th> <th>Qty</th> <th>UOM</th> </tr> </thead> <tbody> <tr> <td>RC1243A0</td> <td>Ø10F-Ø10M ELBOW CONNECTION + JG END KIT</td> <td>10</td> <td>PZ</td> </tr> </tbody> </table>	Code	Description	Qty	UOM	RC1243A0	Ø10F-Ø10M ELBOW CONNECTION + JG END KIT	10	PZ																																			
Code	Description	Qty	UOM																																										
RC1243A0	Ø10F-Ø10M ELBOW CONNECTION + JG END KIT	10	PZ																																										
VL1014A	PRESSURE REDUCER WITH DISTRIBUTOR		KVL1117A	EUR MM 2016+LMT FILTER+PRESS. RED. KIT	<table border="1"> <thead> <tr> <th>Code</th> <th>Description</th> <th>Qty</th> <th>UOM</th> </tr> </thead> <tbody> <tr> <td>0H7472A1</td> <td>DISTRIBUTOR SUPPORT PLATE</td> <td>1</td> <td>PZ</td> </tr> <tr> <td>RC1004A0</td> <td>Ø10-Ø8-8 Y CONNECTION</td> <td>1</td> <td>PZ</td> </tr> <tr> <td>RC1243A0</td> <td>Ø10F-Ø10M ELBOW CONNECTION + JG END KIT</td> <td>1</td> <td>PZ</td> </tr> <tr> <td>RC1372A0</td> <td>Ø10M-1/4 M CIL. STRAIGHT FITTING</td> <td>2</td> <td>PZ</td> </tr> <tr> <td>VI1220A1</td> <td>4,2X12 TCB SELF-TAPPIN G SCREW</td> <td>4</td> <td>PZ</td> </tr> </tbody> </table>	Code	Description	Qty	UOM	0H7472A1	DISTRIBUTOR SUPPORT PLATE	1	PZ	RC1004A0	Ø10-Ø8-8 Y CONNECTION	1	PZ	RC1243A0	Ø10F-Ø10M ELBOW CONNECTION + JG END KIT	1	PZ	RC1372A0	Ø10M-1/4 M CIL. STRAIGHT FITTING	2	PZ	VI1220A1	4,2X12 TCB SELF-TAPPIN G SCREW	4	PZ																
Code	Description	Qty	UOM																																										
0H7472A1	DISTRIBUTOR SUPPORT PLATE	1	PZ																																										
RC1004A0	Ø10-Ø8-8 Y CONNECTION	1	PZ																																										
RC1243A0	Ø10F-Ø10M ELBOW CONNECTION + JG END KIT	1	PZ																																										
RC1372A0	Ø10M-1/4 M CIL. STRAIGHT FITTING	2	PZ																																										
VI1220A1	4,2X12 TCB SELF-TAPPIN G SCREW	4	PZ																																										

COMPONENT			SPARE PART																											
Code	Description	Image	Code	Description	Components list																									
VL1014A	PRESSURE REDUCER WITH DISTRIBUTOR		KVL1117A	EUR MM 2016+LMT FILTER+PRESS. RED. KIT	<table border="1"> <thead> <tr> <th>Code</th> <th>Description</th> <th>Qty</th> <th>UOM</th> </tr> </thead> <tbody> <tr> <td>VL1014B1</td> <td>PRESSURE REDUCER WITH DISTRIBUTOR</td> <td>1</td> <td>PZ</td> </tr> <tr> <td>VL1034C0</td> <td>MESH WATER FILTER D10</td> <td>1</td> <td>PZ</td> </tr> <tr> <td>VL1062C0</td> <td>PRESSURE REDUCER-FILTER LOCKING FORK</td> <td>1</td> <td>PZ</td> </tr> <tr> <td>VM1054A0</td> <td>H7.8 PRESSURE REDUCER RING NUT</td> <td>1</td> <td>PZ</td> </tr> </tbody> </table>	Code	Description	Qty	UOM	VL1014B1	PRESSURE REDUCER WITH DISTRIBUTOR	1	PZ	VL1034C0	MESH WATER FILTER D10	1	PZ	VL1062C0	PRESSURE REDUCER-FILTER LOCKING FORK	1	PZ	VM1054A0	H7.8 PRESSURE REDUCER RING NUT	1	PZ					
			Code	Description	Qty	UOM																								
			VL1014B1	PRESSURE REDUCER WITH DISTRIBUTOR	1	PZ																								
VL1034C0	MESH WATER FILTER D10	1	PZ																											
VL1062C0	PRESSURE REDUCER-FILTER LOCKING FORK	1	PZ																											
VM1054A0	H7.8 PRESSURE REDUCER RING NUT	1	PZ																											
KVL1071A	5E US VERSION PRESSURE REDUCER KIT	<table border="1"> <thead> <tr> <th>Code</th> <th>Description</th> <th>Qty</th> <th>UOM</th> </tr> </thead> <tbody> <tr> <td>RC1003A0</td> <td>8M-1/8 BSPP FITTING</td> <td>2</td> <td>PZ</td> </tr> <tr> <td>RC1372A0</td> <td>Ø10M-1/4 M CIL. STRAIGHT FITTING</td> <td>1</td> <td>PZ</td> </tr> <tr> <td>VL1014A1</td> <td>PRESSURE REDUCER WITH DISTRIBUTOR</td> <td>1</td> <td>PZ</td> </tr> <tr> <td>VM2028A0</td> <td>20X10X4 RUBBER WASHER</td> <td>1</td> <td>PZ</td> </tr> <tr> <td>VM2059A0</td> <td>1/4" CAP WITH O-RING SEAL</td> <td>1</td> <td>PZ</td> </tr> </tbody> </table>	Code	Description	Qty	UOM	RC1003A0	8M-1/8 BSPP FITTING	2	PZ	RC1372A0	Ø10M-1/4 M CIL. STRAIGHT FITTING	1	PZ	VL1014A1	PRESSURE REDUCER WITH DISTRIBUTOR	1	PZ	VM2028A0	20X10X4 RUBBER WASHER	1	PZ	VM2059A0	1/4" CAP WITH O-RING SEAL	1	PZ				
Code	Description	Qty	UOM																											
RC1003A0	8M-1/8 BSPP FITTING	2	PZ																											
RC1372A0	Ø10M-1/4 M CIL. STRAIGHT FITTING	1	PZ																											
VL1014A1	PRESSURE REDUCER WITH DISTRIBUTOR	1	PZ																											
VM2028A0	20X10X4 RUBBER WASHER	1	PZ																											
VM2059A0	1/4" CAP WITH O-RING SEAL	1	PZ																											
KVL1014A	5E PRESSURE REDUCER KIT	<table border="1"> <thead> <tr> <th>Code</th> <th>Description</th> <th>Qty</th> <th>UOM</th> </tr> </thead> <tbody> <tr> <td>EL1185A0</td> <td>Ø8F - Ø8F ELBOW CONNECTION</td> <td>1</td> <td>PZ</td> </tr> <tr> <td>RC1003A0</td> <td>8M-1/8 BSPP FITTING</td> <td>2</td> <td>PZ</td> </tr> <tr> <td>RC1372A0</td> <td>Ø10M-1/4 M CIL. STRAIGHT FITTING</td> <td>1</td> <td>PZ</td> </tr> <tr> <td>VL1014A1</td> <td>PRESSURE REDUCER WITH DISTRIBUTOR</td> <td>1</td> <td>PZ</td> </tr> <tr> <td>VM2028A0</td> <td>20X10X4 RUBBER WASHER</td> <td>1</td> <td>PZ</td> </tr> <tr> <td>VM2059A0</td> <td>1/4" CAP WITH O-RING SEAL</td> <td>1</td> <td>PZ</td> </tr> </tbody> </table>	Code	Description	Qty	UOM	EL1185A0	Ø8F - Ø8F ELBOW CONNECTION	1	PZ	RC1003A0	8M-1/8 BSPP FITTING	2	PZ	RC1372A0	Ø10M-1/4 M CIL. STRAIGHT FITTING	1	PZ	VL1014A1	PRESSURE REDUCER WITH DISTRIBUTOR	1	PZ	VM2028A0	20X10X4 RUBBER WASHER	1	PZ	VM2059A0	1/4" CAP WITH O-RING SEAL	1	PZ
Code	Description	Qty	UOM																											
EL1185A0	Ø8F - Ø8F ELBOW CONNECTION	1	PZ																											
RC1003A0	8M-1/8 BSPP FITTING	2	PZ																											
RC1372A0	Ø10M-1/4 M CIL. STRAIGHT FITTING	1	PZ																											
VL1014A1	PRESSURE REDUCER WITH DISTRIBUTOR	1	PZ																											
VM2028A0	20X10X4 RUBBER WASHER	1	PZ																											
VM2059A0	1/4" CAP WITH O-RING SEAL	1	PZ																											
KVL0014A	EUR MIND.MAPS PRESSURE REDUCER KIT 2016	<table border="1"> <thead> <tr> <th>Code</th> <th>Description</th> <th>Qty</th> <th>UOM</th> </tr> </thead> <tbody> <tr> <td>RC1372A0</td> <td>Ø10M-1/4 M CIL. STRAIGHT FITTING</td> <td>2</td> <td>PZ</td> </tr> </tbody> </table>	Code	Description	Qty	UOM	RC1372A0	Ø10M-1/4 M CIL. STRAIGHT FITTING	2	PZ																				
Code	Description	Qty	UOM																											
RC1372A0	Ø10M-1/4 M CIL. STRAIGHT FITTING	2	PZ																											





COMPONENT			SPARE PART																																										
Code	Description	Image	Code	Description	Components list																																								
VL1014A	PRESSURE REDUCER WITH DISTRIBUTOR		KVL0014A	EUR MIND.MAPS PRESSURE REDUCER KIT 2016	<table border="1"> <thead> <tr> <th>Code</th> <th>Description</th> <th>Qty</th> <th>UOM</th> </tr> </thead> <tbody> <tr> <td>VL1014B1</td> <td>PRESSURE REDUCER WITH DISTRIBUTOR</td> <td>1</td> <td>PZ</td> </tr> <tr> <td>VM1054A0</td> <td>H7.8 PRESSURE REDUCER RING NUT</td> <td>1</td> <td>PZ</td> </tr> </tbody> </table>	Code	Description	Qty	UOM	VL1014B1	PRESSURE REDUCER WITH DISTRIBUTOR	1	PZ	VM1054A0	H7.8 PRESSURE REDUCER RING NUT	1	PZ																												
Code	Description	Qty	UOM																																										
VL1014B1	PRESSURE REDUCER WITH DISTRIBUTOR	1	PZ																																										
VM1054A0	H7.8 PRESSURE REDUCER RING NUT	1	PZ																																										
RC1372A	Ø10M-1/4 M CIL. STRAIGHT FITTING		KVL1117A	EUR MM 2016+LMT FILTER+PRESS. RED. KIT	<table border="1"> <thead> <tr> <th>Code</th> <th>Description</th> <th>Qty</th> <th>UOM</th> </tr> </thead> <tbody> <tr> <td>0H7472A1</td> <td>DISTRIBUTOR SUPPORT PLATE</td> <td>1</td> <td>PZ</td> </tr> <tr> <td>RC1004A0</td> <td>Ø10-Ø8-8 Y CONNECTION</td> <td>1</td> <td>PZ</td> </tr> <tr> <td>RC1243A0</td> <td>Ø10F-Ø10M ELBOW CONNECTION + JG END KIT</td> <td>1</td> <td>PZ</td> </tr> <tr> <td>RC1372A0</td> <td>Ø10M-1/4 M CIL. STRAIGHT FITTING</td> <td>2</td> <td>PZ</td> </tr> <tr> <td>VI1220A1</td> <td>4,2X12 TCB SELF-TAPPING G SCREW</td> <td>4</td> <td>PZ</td> </tr> <tr> <td>VL1014B1</td> <td>PRESSURE REDUCER WITH DISTRIBUTOR</td> <td>1</td> <td>PZ</td> </tr> <tr> <td>VL1034C0</td> <td>MESH WATER FILTER D10</td> <td>1</td> <td>PZ</td> </tr> <tr> <td>VL1062C0</td> <td>PRESSURE REDUCER-FILTER LOCKING FORK</td> <td>1</td> <td>PZ</td> </tr> <tr> <td>VM1054A0</td> <td>H7.8 PRESSURE REDUCER RING NUT</td> <td>1</td> <td>PZ</td> </tr> </tbody> </table>	Code	Description	Qty	UOM	0H7472A1	DISTRIBUTOR SUPPORT PLATE	1	PZ	RC1004A0	Ø10-Ø8-8 Y CONNECTION	1	PZ	RC1243A0	Ø10F-Ø10M ELBOW CONNECTION + JG END KIT	1	PZ	RC1372A0	Ø10M-1/4 M CIL. STRAIGHT FITTING	2	PZ	VI1220A1	4,2X12 TCB SELF-TAPPING G SCREW	4	PZ	VL1014B1	PRESSURE REDUCER WITH DISTRIBUTOR	1	PZ	VL1034C0	MESH WATER FILTER D10	1	PZ	VL1062C0	PRESSURE REDUCER-FILTER LOCKING FORK	1	PZ	VM1054A0	H7.8 PRESSURE REDUCER RING NUT	1	PZ
Code	Description	Qty	UOM																																										
0H7472A1	DISTRIBUTOR SUPPORT PLATE	1	PZ																																										
RC1004A0	Ø10-Ø8-8 Y CONNECTION	1	PZ																																										
RC1243A0	Ø10F-Ø10M ELBOW CONNECTION + JG END KIT	1	PZ																																										
RC1372A0	Ø10M-1/4 M CIL. STRAIGHT FITTING	2	PZ																																										
VI1220A1	4,2X12 TCB SELF-TAPPING G SCREW	4	PZ																																										
VL1014B1	PRESSURE REDUCER WITH DISTRIBUTOR	1	PZ																																										
VL1034C0	MESH WATER FILTER D10	1	PZ																																										
VL1062C0	PRESSURE REDUCER-FILTER LOCKING FORK	1	PZ																																										
VM1054A0	H7.8 PRESSURE REDUCER RING NUT	1	PZ																																										
			KRC1372A	D 10M-1/4 M CIL STRAIGHT CONNECTION KIT	<table border="1"> <thead> <tr> <th>Code</th> <th>Description</th> <th>Qty</th> <th>UOM</th> </tr> </thead> <tbody> <tr> <td>RC1372A0</td> <td>Ø10M-1/4 M CIL. STRAIGHT FITTING</td> <td>1</td> <td>PZ</td> </tr> </tbody> </table>	Code	Description	Qty	UOM	RC1372A0	Ø10M-1/4 M CIL. STRAIGHT FITTING	1	PZ																																
Code	Description	Qty	UOM																																										
RC1372A0	Ø10M-1/4 M CIL. STRAIGHT FITTING	1	PZ																																										
VM1054A	H7.8 PRESSURE REDUCER RING NUT		KVM1054A	H7.8 PRESSURE REDUCER DIAL KIT	<table border="1"> <thead> <tr> <th>Code</th> <th>Description</th> <th>Qty</th> <th>UOM</th> </tr> </thead> <tbody> <tr> <td>VM1054A0</td> <td>H7.8 PRESSURE REDUCER RING NUT</td> <td>1</td> <td>PZ</td> </tr> </tbody> </table>	Code	Description	Qty	UOM	VM1054A0	H7.8 PRESSURE REDUCER RING NUT	1	PZ																																
Code	Description	Qty	UOM																																										
VM1054A0	H7.8 PRESSURE REDUCER RING NUT	1	PZ																																										

COMPONENT			SPARE PART																																										
Code	Description	Image	Code	Description	Components list																																								
VM1054A	H7.8 PRESSURE REDUCER RING NUT		KVL1117A	EUR MM 2016+LMT FILTER+PRESS. RED. KIT	<table border="1"> <thead> <tr> <th>Code</th> <th>Description</th> <th>Qty</th> <th>UOM</th> </tr> </thead> <tbody> <tr> <td>0H7472A1</td> <td>DISTRIBUTOR SUPPORT PLATE</td> <td>1</td> <td>PZ</td> </tr> <tr> <td>RC1004A0</td> <td>Ø10-Ø8-8 Y CONNECTION</td> <td>1</td> <td>PZ</td> </tr> <tr> <td>RC1243A0</td> <td>Ø10F-Ø10M ELBOW CONNECTION + JG END KIT</td> <td>1</td> <td>PZ</td> </tr> <tr> <td>RC1372A0</td> <td>Ø10M-1/4 M CIL. STRAIGHT FITTING</td> <td>2</td> <td>PZ</td> </tr> <tr> <td>VI1220A1</td> <td>4,2X12 TCB SELF-TAPPIN G SCREW</td> <td>4</td> <td>PZ</td> </tr> <tr> <td>VL1014B1</td> <td>PRESSURE REDUCER WITH DISTRIBUTOR</td> <td>1</td> <td>PZ</td> </tr> <tr> <td>VL1034C0</td> <td>MESH WATER FILTER D10</td> <td>1</td> <td>PZ</td> </tr> <tr> <td>VL1062C0</td> <td>PRESSURE REDUCER-FILTER LOCKING FORK</td> <td>1</td> <td>PZ</td> </tr> <tr> <td>VM1054A0</td> <td>H7.8 PRESSURE REDUCER RING NUT</td> <td>1</td> <td>PZ</td> </tr> </tbody> </table>	Code	Description	Qty	UOM	0H7472A1	DISTRIBUTOR SUPPORT PLATE	1	PZ	RC1004A0	Ø10-Ø8-8 Y CONNECTION	1	PZ	RC1243A0	Ø10F-Ø10M ELBOW CONNECTION + JG END KIT	1	PZ	RC1372A0	Ø10M-1/4 M CIL. STRAIGHT FITTING	2	PZ	VI1220A1	4,2X12 TCB SELF-TAPPIN G SCREW	4	PZ	VL1014B1	PRESSURE REDUCER WITH DISTRIBUTOR	1	PZ	VL1034C0	MESH WATER FILTER D10	1	PZ	VL1062C0	PRESSURE REDUCER-FILTER LOCKING FORK	1	PZ	VM1054A0	H7.8 PRESSURE REDUCER RING NUT	1	PZ
Code	Description	Qty	UOM																																										
0H7472A1	DISTRIBUTOR SUPPORT PLATE	1	PZ																																										
RC1004A0	Ø10-Ø8-8 Y CONNECTION	1	PZ																																										
RC1243A0	Ø10F-Ø10M ELBOW CONNECTION + JG END KIT	1	PZ																																										
RC1372A0	Ø10M-1/4 M CIL. STRAIGHT FITTING	2	PZ																																										
VI1220A1	4,2X12 TCB SELF-TAPPIN G SCREW	4	PZ																																										
VL1014B1	PRESSURE REDUCER WITH DISTRIBUTOR	1	PZ																																										
VL1034C0	MESH WATER FILTER D10	1	PZ																																										
VL1062C0	PRESSURE REDUCER-FILTER LOCKING FORK	1	PZ																																										
VM1054A0	H7.8 PRESSURE REDUCER RING NUT	1	PZ																																										
RC1004A	Ø10-Ø8-8 Y CONNECTION		KVL1117A	EUR MM 2016+LMT FILTER+PRESS. RED. KIT	<table border="1"> <thead> <tr> <th>Code</th> <th>Description</th> <th>Qty</th> <th>UOM</th> </tr> </thead> <tbody> <tr> <td>0H7472A1</td> <td>DISTRIBUTOR SUPPORT PLATE</td> <td>1</td> <td>PZ</td> </tr> <tr> <td>RC1004A0</td> <td>Ø10-Ø8-8 Y CONNECTION</td> <td>1</td> <td>PZ</td> </tr> <tr> <td>RC1243A0</td> <td>Ø10F-Ø10M ELBOW CONNECTION + JG END KIT</td> <td>1</td> <td>PZ</td> </tr> <tr> <td>RC1372A0</td> <td>Ø10M-1/4 M CIL. STRAIGHT FITTING</td> <td>2</td> <td>PZ</td> </tr> <tr> <td>VI1220A1</td> <td>4,2X12 TCB SELF-TAPPIN G SCREW</td> <td>4</td> <td>PZ</td> </tr> <tr> <td>VL1014B1</td> <td>PRESSURE REDUCER WITH DISTRIBUTOR</td> <td>1</td> <td>PZ</td> </tr> <tr> <td>VL1034C0</td> <td>MESH WATER FILTER D10</td> <td>1</td> <td>PZ</td> </tr> </tbody> </table>	Code	Description	Qty	UOM	0H7472A1	DISTRIBUTOR SUPPORT PLATE	1	PZ	RC1004A0	Ø10-Ø8-8 Y CONNECTION	1	PZ	RC1243A0	Ø10F-Ø10M ELBOW CONNECTION + JG END KIT	1	PZ	RC1372A0	Ø10M-1/4 M CIL. STRAIGHT FITTING	2	PZ	VI1220A1	4,2X12 TCB SELF-TAPPIN G SCREW	4	PZ	VL1014B1	PRESSURE REDUCER WITH DISTRIBUTOR	1	PZ	VL1034C0	MESH WATER FILTER D10	1	PZ								
Code	Description	Qty	UOM																																										
0H7472A1	DISTRIBUTOR SUPPORT PLATE	1	PZ																																										
RC1004A0	Ø10-Ø8-8 Y CONNECTION	1	PZ																																										
RC1243A0	Ø10F-Ø10M ELBOW CONNECTION + JG END KIT	1	PZ																																										
RC1372A0	Ø10M-1/4 M CIL. STRAIGHT FITTING	2	PZ																																										
VI1220A1	4,2X12 TCB SELF-TAPPIN G SCREW	4	PZ																																										
VL1014B1	PRESSURE REDUCER WITH DISTRIBUTOR	1	PZ																																										
VL1034C0	MESH WATER FILTER D10	1	PZ																																										

COMPONENT			SPARE PART																																										
Code	Description	Image	Code	Description	Components list																																								
RC1004A	Ø10-Ø8-8 Y CONNECTION		KVL1117A	EUR MM 2016+LMT FILTER+PRESS. RED. KIT	<table border="1"> <thead> <tr> <th>Code</th> <th>Description</th> <th>Qty</th> <th>UOM</th> </tr> </thead> <tbody> <tr> <td>VL1062C0</td> <td>PRESSURE REDUCER-FIL TER LOCKING FORK</td> <td>1</td> <td>PZ</td> </tr> <tr> <td>VM1054A0</td> <td>H7.8 PRESSURE REDUCER RING NUT</td> <td>1</td> <td>PZ</td> </tr> </tbody> </table>	Code	Description	Qty	UOM	VL1062C0	PRESSURE REDUCER-FIL TER LOCKING FORK	1	PZ	VM1054A0	H7.8 PRESSURE REDUCER RING NUT	1	PZ																												
			Code	Description	Qty	UOM																																							
VL1062C0	PRESSURE REDUCER-FIL TER LOCKING FORK	1	PZ																																										
VM1054A0	H7.8 PRESSURE REDUCER RING NUT	1	PZ																																										
KRC1004A	10 PCS Ø10-Ø8-8 JG Y FITTING KIT	<table border="1"> <thead> <tr> <th>Code</th> <th>Description</th> <th>Qty</th> <th>UOM</th> </tr> </thead> <tbody> <tr> <td>RC1004A0</td> <td>Ø10-Ø8-8 Y CONNECTION</td> <td>10</td> <td>PZ</td> </tr> </tbody> </table>	Code	Description	Qty	UOM	RC1004A0	Ø10-Ø8-8 Y CONNECTION	10	PZ																																			
Code	Description	Qty	UOM																																										
RC1004A0	Ø10-Ø8-8 Y CONNECTION	10	PZ																																										
VL1034C	MESH WATER FILTER D10		KVL1117A	EUR MM 2016+LMT FILTER+PRESS. RED. KIT	<table border="1"> <thead> <tr> <th>Code</th> <th>Description</th> <th>Qty</th> <th>UOM</th> </tr> </thead> <tbody> <tr> <td>0H7472A1</td> <td>DISTRIBUTOR SUPPORT PLATE</td> <td>1</td> <td>PZ</td> </tr> <tr> <td>RC1004A0</td> <td>Ø10-Ø8-8 Y CONNECTION</td> <td>1</td> <td>PZ</td> </tr> <tr> <td>RC1243A0</td> <td>Ø10F-Ø10M ELBOW CONNECTION + JG END KIT</td> <td>1</td> <td>PZ</td> </tr> <tr> <td>RC1372A0</td> <td>Ø10M-1/4 M CIL. STRAIGHT FITTING</td> <td>2</td> <td>PZ</td> </tr> <tr> <td>VI1220A1</td> <td>4,2X12 TCB SELF-TAPPIN G SCREW</td> <td>4</td> <td>PZ</td> </tr> <tr> <td>VL1014B1</td> <td>PRESSURE REDUCER WITH DISTRIBUTOR</td> <td>1</td> <td>PZ</td> </tr> <tr> <td>VL1034C0</td> <td>MESH WATER FILTER D10</td> <td>1</td> <td>PZ</td> </tr> <tr> <td>VL1062C0</td> <td>PRESSURE REDUCER-FIL TER LOCKING FORK</td> <td>1</td> <td>PZ</td> </tr> <tr> <td>VM1054A0</td> <td>H7.8 PRESSURE REDUCER RING NUT</td> <td>1</td> <td>PZ</td> </tr> </tbody> </table>	Code	Description	Qty	UOM	0H7472A1	DISTRIBUTOR SUPPORT PLATE	1	PZ	RC1004A0	Ø10-Ø8-8 Y CONNECTION	1	PZ	RC1243A0	Ø10F-Ø10M ELBOW CONNECTION + JG END KIT	1	PZ	RC1372A0	Ø10M-1/4 M CIL. STRAIGHT FITTING	2	PZ	VI1220A1	4,2X12 TCB SELF-TAPPIN G SCREW	4	PZ	VL1014B1	PRESSURE REDUCER WITH DISTRIBUTOR	1	PZ	VL1034C0	MESH WATER FILTER D10	1	PZ	VL1062C0	PRESSURE REDUCER-FIL TER LOCKING FORK	1	PZ	VM1054A0	H7.8 PRESSURE REDUCER RING NUT	1	PZ
			Code	Description	Qty	UOM																																							
			0H7472A1	DISTRIBUTOR SUPPORT PLATE	1	PZ																																							
			RC1004A0	Ø10-Ø8-8 Y CONNECTION	1	PZ																																							
			RC1243A0	Ø10F-Ø10M ELBOW CONNECTION + JG END KIT	1	PZ																																							
			RC1372A0	Ø10M-1/4 M CIL. STRAIGHT FITTING	2	PZ																																							
			VI1220A1	4,2X12 TCB SELF-TAPPIN G SCREW	4	PZ																																							
			VL1014B1	PRESSURE REDUCER WITH DISTRIBUTOR	1	PZ																																							
			VL1034C0	MESH WATER FILTER D10	1	PZ																																							
			VL1062C0	PRESSURE REDUCER-FIL TER LOCKING FORK	1	PZ																																							
			VM1054A0	H7.8 PRESSURE REDUCER RING NUT	1	PZ																																							
			KVL1034C	Ø8-Ø10 MESH100 WATER FILTER KIT	<table border="1"> <thead> <tr> <th>Code</th> <th>Description</th> <th>Qty</th> <th>UOM</th> </tr> </thead> <tbody> <tr> <td>RC1002A0</td> <td>JG 10M-8F TERMINAL REDUCTION FITTING</td> <td>2</td> <td>PZ</td> </tr> <tr> <td>VL1034C0</td> <td>MESH WATER FILTER D10</td> <td>1</td> <td>PZ</td> </tr> <tr> <td>VL1062C0</td> <td>PRESSURE REDUCER-FIL TER LOCKING FORK</td> <td>1</td> <td>PZ</td> </tr> </tbody> </table>	Code	Description	Qty	UOM	RC1002A0	JG 10M-8F TERMINAL REDUCTION FITTING	2	PZ	VL1034C0	MESH WATER FILTER D10	1	PZ	VL1062C0	PRESSURE REDUCER-FIL TER LOCKING FORK	1	PZ																								
Code	Description	Qty	UOM																																										
RC1002A0	JG 10M-8F TERMINAL REDUCTION FITTING	2	PZ																																										
VL1034C0	MESH WATER FILTER D10	1	PZ																																										
VL1062C0	PRESSURE REDUCER-FIL TER LOCKING FORK	1	PZ																																										

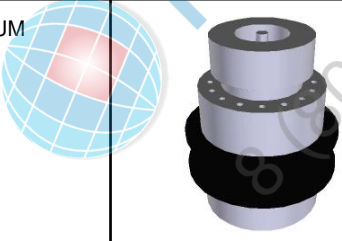
COMPONENT			SPARE PART																																										
Code	Description	Image	Code	Description	Components list																																								
VL1062C	PRESSURE REDUCER-FILTER LOCKING FORK		KVL1117A	EUR MM 2016+LMT FILTER+PRESS. RED. KIT	<table border="1"> <thead> <tr> <th>Code</th> <th>Description</th> <th>Qty</th> <th>UOM</th> </tr> </thead> <tbody> <tr> <td>0H7472A1</td> <td>DISTRIBUTOR SUPPORT PLATE</td> <td>1</td> <td>PZ</td> </tr> <tr> <td>RC1004A0</td> <td>Ø10-Ø8-8 Y CONNECTION</td> <td>1</td> <td>PZ</td> </tr> <tr> <td>RC1243A0</td> <td>Ø10F-Ø10M ELBOW CONNECTION + JG END KIT</td> <td>1</td> <td>PZ</td> </tr> <tr> <td>RC1372A0</td> <td>Ø10M-1/4 M CIL. STRAIGHT FITTING</td> <td>2</td> <td>PZ</td> </tr> <tr> <td>VI1220A1</td> <td>4,2X12 TCB SELF-TAPPIN G SCREW</td> <td>4</td> <td>PZ</td> </tr> <tr> <td>VL1014B1</td> <td>PRESSURE REDUCER WITH DISTRIBUTOR</td> <td>1</td> <td>PZ</td> </tr> <tr> <td>VL1034C0</td> <td>MESH WATER FILTER D10</td> <td>1</td> <td>PZ</td> </tr> <tr> <td>VL1062C0</td> <td>PRESSURE REDUCER-FILTER LOCKING FORK</td> <td>1</td> <td>PZ</td> </tr> <tr> <td>VM1054A0</td> <td>H7.8 PRESSURE REDUCER RING NUT</td> <td>1</td> <td>PZ</td> </tr> </tbody> </table>	Code	Description	Qty	UOM	0H7472A1	DISTRIBUTOR SUPPORT PLATE	1	PZ	RC1004A0	Ø10-Ø8-8 Y CONNECTION	1	PZ	RC1243A0	Ø10F-Ø10M ELBOW CONNECTION + JG END KIT	1	PZ	RC1372A0	Ø10M-1/4 M CIL. STRAIGHT FITTING	2	PZ	VI1220A1	4,2X12 TCB SELF-TAPPIN G SCREW	4	PZ	VL1014B1	PRESSURE REDUCER WITH DISTRIBUTOR	1	PZ	VL1034C0	MESH WATER FILTER D10	1	PZ	VL1062C0	PRESSURE REDUCER-FILTER LOCKING FORK	1	PZ	VM1054A0	H7.8 PRESSURE REDUCER RING NUT	1	PZ
					Code	Description	Qty	UOM																																					
0H7472A1	DISTRIBUTOR SUPPORT PLATE	1	PZ																																										
RC1004A0	Ø10-Ø8-8 Y CONNECTION	1	PZ																																										
RC1243A0	Ø10F-Ø10M ELBOW CONNECTION + JG END KIT	1	PZ																																										
RC1372A0	Ø10M-1/4 M CIL. STRAIGHT FITTING	2	PZ																																										
VI1220A1	4,2X12 TCB SELF-TAPPIN G SCREW	4	PZ																																										
VL1014B1	PRESSURE REDUCER WITH DISTRIBUTOR	1	PZ																																										
VL1034C0	MESH WATER FILTER D10	1	PZ																																										
VL1062C0	PRESSURE REDUCER-FILTER LOCKING FORK	1	PZ																																										
VM1054A0	H7.8 PRESSURE REDUCER RING NUT	1	PZ																																										
<table border="1"> <thead> <tr> <th>Code</th> <th>Description</th> <th>Qty</th> <th>UOM</th> </tr> </thead> <tbody> <tr> <td>RC1002A0</td> <td>JG 10M-8F TERMINAL REDUCTION FITTING</td> <td>2</td> <td>PZ</td> </tr> <tr> <td>VL1034C0</td> <td>MESH WATER FILTER D10</td> <td>1</td> <td>PZ</td> </tr> <tr> <td>VL1062C0</td> <td>PRESSURE REDUCER-FILTER LOCKING FORK</td> <td>1</td> <td>PZ</td> </tr> </tbody> </table>	Code	Description	Qty	UOM	RC1002A0	JG 10M-8F TERMINAL REDUCTION FITTING	2	PZ	VL1034C0	MESH WATER FILTER D10	1	PZ	VL1062C0	PRESSURE REDUCER-FILTER LOCKING FORK	1	PZ																													
Code	Description	Qty	UOM																																										
RC1002A0	JG 10M-8F TERMINAL REDUCTION FITTING	2	PZ																																										
VL1034C0	MESH WATER FILTER D10	1	PZ																																										
VL1062C0	PRESSURE REDUCER-FILTER LOCKING FORK	1	PZ																																										
0H7472A	DISTRIBUTOR SUPPORT PLATE		KVL1117A	EUR MM 2016+LMT FILTER+PRESS. RED. KIT	<table border="1"> <thead> <tr> <th>Code</th> <th>Description</th> <th>Qty</th> <th>UOM</th> </tr> </thead> <tbody> <tr> <td>0H7472A1</td> <td>DISTRIBUTOR SUPPORT PLATE</td> <td>1</td> <td>PZ</td> </tr> <tr> <td>RC1004A0</td> <td>Ø10-Ø8-8 Y CONNECTION</td> <td>1</td> <td>PZ</td> </tr> <tr> <td>RC1243A0</td> <td>Ø10F-Ø10M ELBOW CONNECTION + JG END KIT</td> <td>1</td> <td>PZ</td> </tr> <tr> <td>RC1372A0</td> <td>Ø10M-1/4 M CIL. STRAIGHT FITTING</td> <td>2</td> <td>PZ</td> </tr> </tbody> </table>	Code	Description	Qty	UOM	0H7472A1	DISTRIBUTOR SUPPORT PLATE	1	PZ	RC1004A0	Ø10-Ø8-8 Y CONNECTION	1	PZ	RC1243A0	Ø10F-Ø10M ELBOW CONNECTION + JG END KIT	1	PZ	RC1372A0	Ø10M-1/4 M CIL. STRAIGHT FITTING	2	PZ																				
					Code	Description	Qty	UOM																																					
0H7472A1	DISTRIBUTOR SUPPORT PLATE	1	PZ																																										
RC1004A0	Ø10-Ø8-8 Y CONNECTION	1	PZ																																										
RC1243A0	Ø10F-Ø10M ELBOW CONNECTION + JG END KIT	1	PZ																																										
RC1372A0	Ø10M-1/4 M CIL. STRAIGHT FITTING	2	PZ																																										

COMPONENT			SPARE PART																										
Code	Description	Image	Code	Description	Components list																								
0H7472A	DISTRIBUTOR SUPPORT PLATE		KVL1117A	EUR MM 2016+LMT FILTER+PRESS. RED. KIT	<table border="1"> <thead> <tr> <th>Code</th> <th>Description</th> <th>Qty</th> <th>UOM</th> </tr> </thead> <tbody> <tr> <td>VL1220A1</td> <td>4,2X12 TCB SELF-TAPPIN G SCREW</td> <td>4</td> <td>PZ</td> </tr> <tr> <td>VL1014B1</td> <td>PRESSURE REDUCER WITH DISTRIBUTOR</td> <td>1</td> <td>PZ</td> </tr> <tr> <td>VL1034C0</td> <td>MESH WATER FILTER D10</td> <td>1</td> <td>PZ</td> </tr> <tr> <td>VL1062C0</td> <td>PRESSURE REDUCER-FIL TER LOCKING FORK</td> <td>1</td> <td>PZ</td> </tr> <tr> <td>VM1054A0</td> <td>H7.8 PRESSURE REDUCER RING NUT</td> <td>1</td> <td>PZ</td> </tr> </tbody> </table>	Code	Description	Qty	UOM	VL1220A1	4,2X12 TCB SELF-TAPPIN G SCREW	4	PZ	VL1014B1	PRESSURE REDUCER WITH DISTRIBUTOR	1	PZ	VL1034C0	MESH WATER FILTER D10	1	PZ	VL1062C0	PRESSURE REDUCER-FIL TER LOCKING FORK	1	PZ	VM1054A0	H7.8 PRESSURE REDUCER RING NUT	1	PZ
					Code	Description	Qty	UOM																					
VL1220A1	4,2X12 TCB SELF-TAPPIN G SCREW	4	PZ																										
VL1014B1	PRESSURE REDUCER WITH DISTRIBUTOR	1	PZ																										
VL1034C0	MESH WATER FILTER D10	1	PZ																										
VL1062C0	PRESSURE REDUCER-FIL TER LOCKING FORK	1	PZ																										
VM1054A0	H7.8 PRESSURE REDUCER RING NUT	1	PZ																										
K0H7472A	DISTRIBUTOR SUPPORT PLATE KI																												
VL1085A	3/4" VACUUM BREAKER		KRC1365A	3/4"-10 OR 8 JG WATER CONNECTION KIT	<table border="1"> <thead> <tr> <th>Code</th> <th>Description</th> <th>Qty</th> <th>UOM</th> </tr> </thead> <tbody> <tr> <td>GN1200A1</td> <td>3/4 CONNECTION SEAL D=24 RUBBER+NET</td> <td>1</td> <td>PZ</td> </tr> <tr> <td>RC1002A0</td> <td>JG 10M-8F TERMINAL REDUCTION FITTING</td> <td>1</td> <td>PZ</td> </tr> <tr> <td>RC1365A0</td> <td>3/4"-10 JG FEMALE CONNECTION</td> <td>1</td> <td>PZ</td> </tr> </tbody> </table>	Code	Description	Qty	UOM	GN1200A1	3/4 CONNECTION SEAL D=24 RUBBER+NET	1	PZ	RC1002A0	JG 10M-8F TERMINAL REDUCTION FITTING	1	PZ	RC1365A0	3/4"-10 JG FEMALE CONNECTION	1	PZ								
					Code	Description	Qty	UOM																					
					GN1200A1	3/4 CONNECTION SEAL D=24 RUBBER+NET	1	PZ																					
RC1002A0	JG 10M-8F TERMINAL REDUCTION FITTING	1	PZ																										
RC1365A0	3/4"-10 JG FEMALE CONNECTION	1	PZ																										
RC1405A																													
																													
			OUTOFPRODUCTIO																										

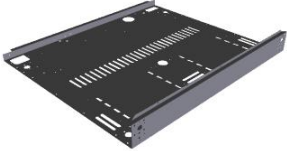

COMPONENT			SPARE PART		
Code	Description	Image	Code	Description	Components list
0E1350A	GN1-1 XEVC EXTERNAL BOTTOM PANEL		0E1350A1	GN1-1 XEVC EXTERNAL BOTTOM PANEL	



PLATON SERVICE  
8 (800) 500-34-47  
www.platonservice.com

ASM2926A/0.D01 - Electrical system

FRONT

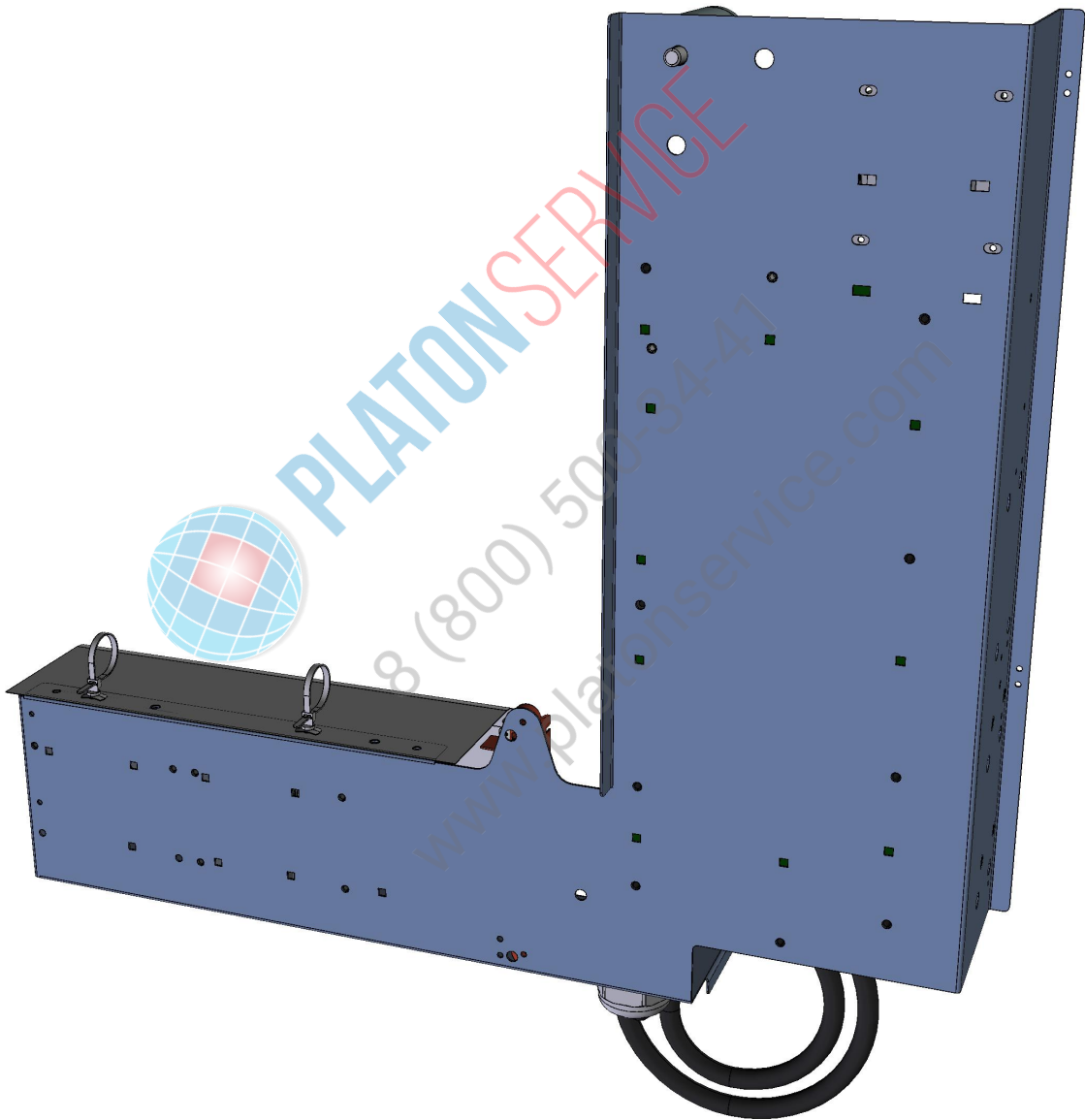

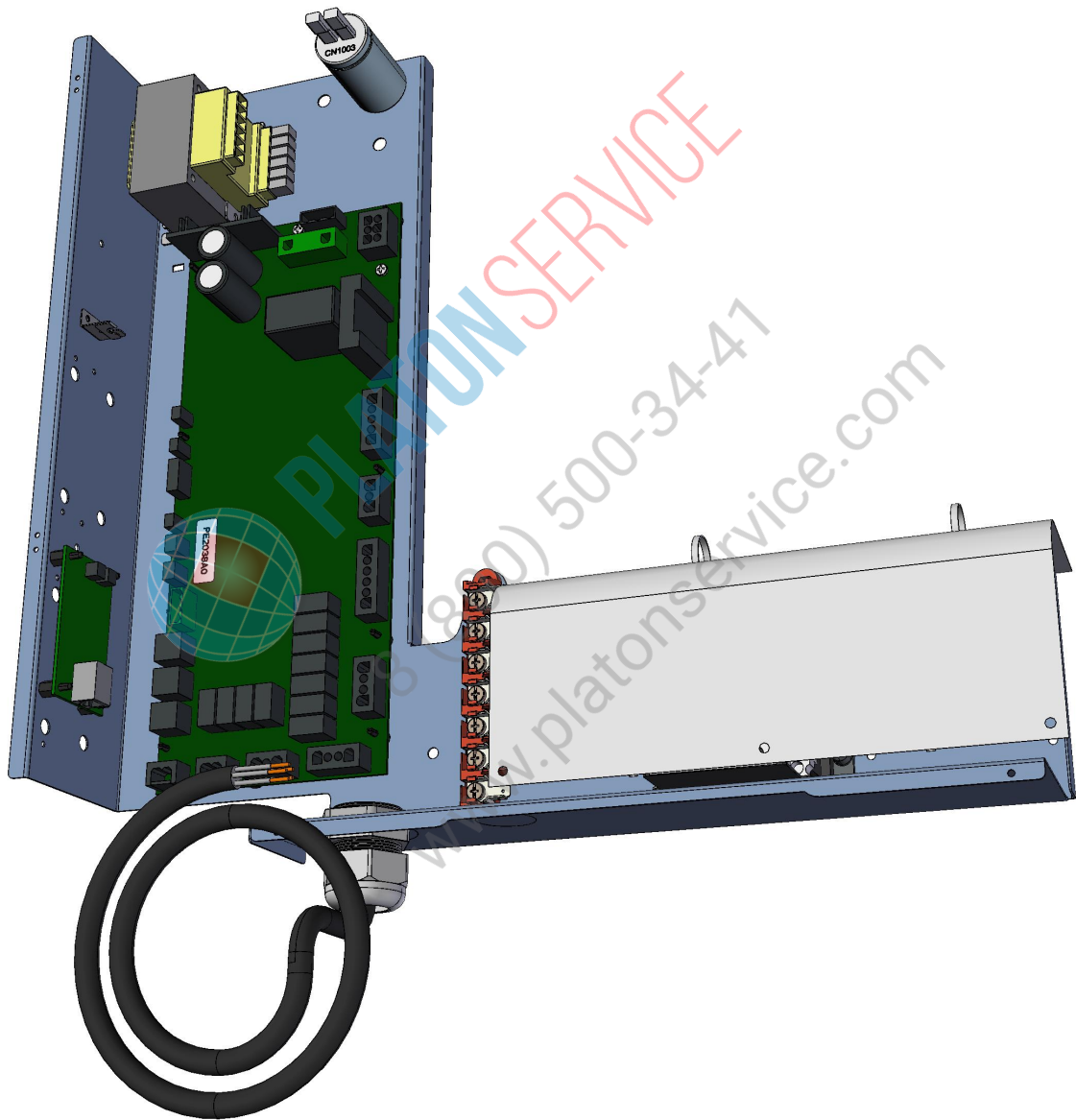

ASM2926A/0.D01 - Electrical system

REAR



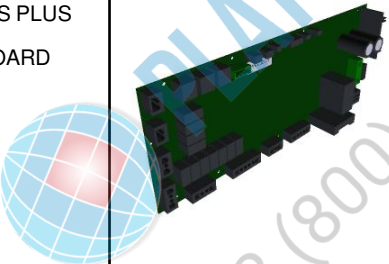
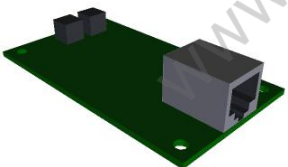

COMPONENT			SPARE PART																		
Code	Description	Image	Code	Description	Components list																
CN1003A	6,3 UF MOTOR CAPACITOR		KCN1003A	6,3 UF MOTOR CAPACITOR KIT	<table border="1"> <thead> <tr> <th>Code</th> <th>Description</th> <th>Qty</th> <th>UOM</th> </tr> </thead> <tbody> <tr> <td>CN1003A0</td> <td>6,3 UF MOTOR CAPACITOR</td> <td>1</td> <td>PZ</td> </tr> <tr> <td>VI1931A0</td> <td>M8 NUT+INDENTE D WASHER D=8 X COND.</td> <td>1</td> <td>PZ</td> </tr> <tr> <td>VI1932A0</td> <td>M8 NUT+INDENTE D WASHER D=8 X COND.</td> <td>1</td> <td>PZ</td> </tr> </tbody> </table>	Code	Description	Qty	UOM	CN1003A0	6,3 UF MOTOR CAPACITOR	1	PZ	VI1931A0	M8 NUT+INDENTE D WASHER D=8 X COND.	1	PZ	VI1932A0	M8 NUT+INDENTE D WASHER D=8 X COND.	1	PZ
Code	Description	Qty	UOM																		
CN1003A0	6,3 UF MOTOR CAPACITOR	1	PZ																		
VI1931A0	M8 NUT+INDENTE D WASHER D=8 X COND.	1	PZ																		
VI1932A0	M8 NUT+INDENTE D WASHER D=8 X COND.	1	PZ																		
MR1004A	41A 450V 7 POLES TERMINAL		KMR1004A	7FTW 1+2+3/4+5+6 TERMINAL BLOCK KIT	<table border="1"> <thead> <tr> <th>Code</th> <th>Description</th> <th>Qty</th> <th>UOM</th> </tr> </thead> <tbody> <tr> <td>MR1004A1</td> <td>41A 450V 7 POLES TERMINAL</td> <td>1</td> <td>PZ</td> </tr> </tbody> </table>	Code	Description	Qty	UOM	MR1004A1	41A 450V 7 POLES TERMINAL	1	PZ								
Code	Description	Qty	UOM																		
MR1004A1	41A 450V 7 POLES TERMINAL	1	PZ																		
VE1026A	230-21-12VAC 80VA TRANSFORMER		KVE1026A	230-21-12VAC 90VA TRANSFORMER KIT	<table border="1"> <thead> <tr> <th>Code</th> <th>Description</th> <th>Qty</th> <th>UOM</th> </tr> </thead> <tbody> <tr> <td>VE1026A0</td> <td>230-21-12VAC 80VA TRANSFORMER</td> <td>1</td> <td>PZ</td> </tr> <tr> <td>VI1950A0</td> <td>ST. STEEL 4,2X13 TCB SELF-DRILLIN G SCREW</td> <td>4</td> <td>PZ</td> </tr> </tbody> </table>	Code	Description	Qty	UOM	VE1026A0	230-21-12VAC 80VA TRANSFORMER	1	PZ	VI1950A0	ST. STEEL 4,2X13 TCB SELF-DRILLIN G SCREW	4	PZ				
Code	Description	Qty	UOM																		
VE1026A0	230-21-12VAC 80VA TRANSFORMER	1	PZ																		
VI1950A0	ST. STEEL 4,2X13 TCB SELF-DRILLIN G SCREW	4	PZ																		
VM2191A	BRACKET FOR BIG CONTACTOR VE109		VM2191A0	BRACKET FOR BIG CONTACTOR VE109																	
VE1095A	GE 25A 230V REMOTE CONTROL SWITCH		KVE1095A	HEATING ELEMENT CONTACTOR KIT	<table border="1"> <thead> <tr> <th>Code</th> <th>Description</th> <th>Qty</th> <th>UOM</th> </tr> </thead> <tbody> <tr> <td>VE1095A0</td> <td>GE 25A 230V REMOTE CONTROL SWITCH</td> <td>1</td> <td>PZ</td> </tr> <tr> <td>VM1075A1</td> <td>PLASTIC CLIP TO FIX CONTACTORS</td> <td>4</td> <td>PZ</td> </tr> </tbody> </table>	Code	Description	Qty	UOM	VE1095A0	GE 25A 230V REMOTE CONTROL SWITCH	1	PZ	VM1075A1	PLASTIC CLIP TO FIX CONTACTORS	4	PZ				
Code	Description	Qty	UOM																		
VE1095A0	GE 25A 230V REMOTE CONTROL SWITCH	1	PZ																		
VM1075A1	PLASTIC CLIP TO FIX CONTACTORS	4	PZ																		

COMPONENT			SPARE PART																														
Code	Description	Image	Code	Description	Components list																												
VE1645A	PG 29 STRAIN RELIEF NUT		OUTOFPRODUCTIO																														
VE1644A	PG 29 STRAIN RELIEF NUT		VE1644A0	PG 29 STRAIN RELIEF NUT																													
PE2038A	MIND.MAPS PLUS POWER BOARD		KPE2038A	MIND.MAPS PLUS POWER BOARD KIT	<table border="1"> <thead> <tr> <th>Code</th> <th>Description</th> <th>Qty</th> <th>UOM</th> </tr> </thead> <tbody> <tr> <td>PE2038A0</td> <td>MIND.MAPS PLUS POWER BOARD</td> <td>1</td> <td>PZ</td> </tr> <tr> <td>V11850A0</td> <td>M4X6 NICKEL PLATED FIXING SCREW</td> <td>12</td> <td>PZ</td> </tr> <tr> <td>VM1745A0</td> <td>CARD SUPPORT</td> <td>12</td> <td>PZ</td> </tr> <tr> <td>VM2147A0</td> <td>ESD SPONGE PINK SMOOTH 410X343X15 M</td> <td>1</td> <td>PZ</td> </tr> </tbody> </table>	Code	Description	Qty	UOM	PE2038A0	MIND.MAPS PLUS POWER BOARD	1	PZ	V11850A0	M4X6 NICKEL PLATED FIXING SCREW	12	PZ	VM1745A0	CARD SUPPORT	12	PZ	VM2147A0	ESD SPONGE PINK SMOOTH 410X343X15 M	1	PZ								
Code	Description	Qty	UOM																														
PE2038A0	MIND.MAPS PLUS POWER BOARD	1	PZ																														
V11850A0	M4X6 NICKEL PLATED FIXING SCREW	12	PZ																														
VM1745A0	CARD SUPPORT	12	PZ																														
VM2147A0	ESD SPONGE PINK SMOOTH 410X343X15 M	1	PZ																														
PE2052A	MM LAN CONNECTION BRIDGE		XEC001	UNOX.LINK ETHERNET CONNECTION ONE/PLUS	<table border="1"> <thead> <tr> <th>Code</th> <th>Description</th> <th>Qty</th> <th>UOM</th> </tr> </thead> <tbody> <tr> <td>0H7386B0</td> <td>SOUS VIDE PROBE BOARD SUPPORT</td> <td>1</td> <td>PZ</td> </tr> <tr> <td>CE1065A0</td> <td>4X0.5 MICROFIT WIRE 4P-500MM-MICROFIT4P</td> <td>1</td> <td>PZ</td> </tr> <tr> <td>PE2052A0</td> <td>MM LAN CONNECTION BRIDGE</td> <td>1</td> <td>PZ</td> </tr> <tr> <td>V11850A0</td> <td>M4X6 NICKEL PLATED FIXING SCREW</td> <td>6</td> <td>PZ</td> </tr> <tr> <td>VM1745A0</td> <td>CARD SUPPORT</td> <td>4</td> <td>PZ</td> </tr> <tr> <td>VM2147A0</td> <td>ESD SPONGE PINK SMOOTH 410X343X15 M</td> <td>1</td> <td>PZ</td> </tr> </tbody> </table>	Code	Description	Qty	UOM	0H7386B0	SOUS VIDE PROBE BOARD SUPPORT	1	PZ	CE1065A0	4X0.5 MICROFIT WIRE 4P-500MM-MICROFIT4P	1	PZ	PE2052A0	MM LAN CONNECTION BRIDGE	1	PZ	V11850A0	M4X6 NICKEL PLATED FIXING SCREW	6	PZ	VM1745A0	CARD SUPPORT	4	PZ	VM2147A0	ESD SPONGE PINK SMOOTH 410X343X15 M	1	PZ
Code	Description	Qty	UOM																														
0H7386B0	SOUS VIDE PROBE BOARD SUPPORT	1	PZ																														
CE1065A0	4X0.5 MICROFIT WIRE 4P-500MM-MICROFIT4P	1	PZ																														
PE2052A0	MM LAN CONNECTION BRIDGE	1	PZ																														
V11850A0	M4X6 NICKEL PLATED FIXING SCREW	6	PZ																														
VM1745A0	CARD SUPPORT	4	PZ																														
VM2147A0	ESD SPONGE PINK SMOOTH 410X343X15 M	1	PZ																														



COMPONENT			SPARE PART										
Code	Description	Image	Code	Description	Components list								
0H7374A	CORE PROBE CABLE PLATE		0H7374A0	CORE PROBE CABLE PLATE									
CE1355A	CABLE 5 X 2,5 MMQ H07RNF L = 1,5 MT		KCE1355A	CONNECTOR KIT	<table border="1"> <thead> <tr> <th>Code</th> <th>Description</th> <th>Qty</th> <th>UOM</th> </tr> </thead> <tbody> <tr> <td>CE1355A1</td> <td>CABLE 5 X 2,5 MMQ H07RNF L = 1,5 MT</td> <td>1</td> <td>PZ</td> </tr> </tbody> </table>	Code	Description	Qty	UOM	CE1355A1	CABLE 5 X 2,5 MMQ H07RNF L = 1,5 MT	1	PZ
Code	Description	Qty	UOM										
CE1355A1	CABLE 5 X 2,5 MMQ H07RNF L = 1,5 MT	1	PZ										
VM2387A	XEVC MM CONTACTORS PROTECTION		VM2387A0	XEVC MM CONTACTORS PROTECTION									
0H7250A	MM ONE GN1/1 ELECT. COMPONENTS HOLDER		0H7250A0	MM ONE GN1/1 ELECT. COMPONENTS HOLDER									

ASM2921A/0.D01 - Door

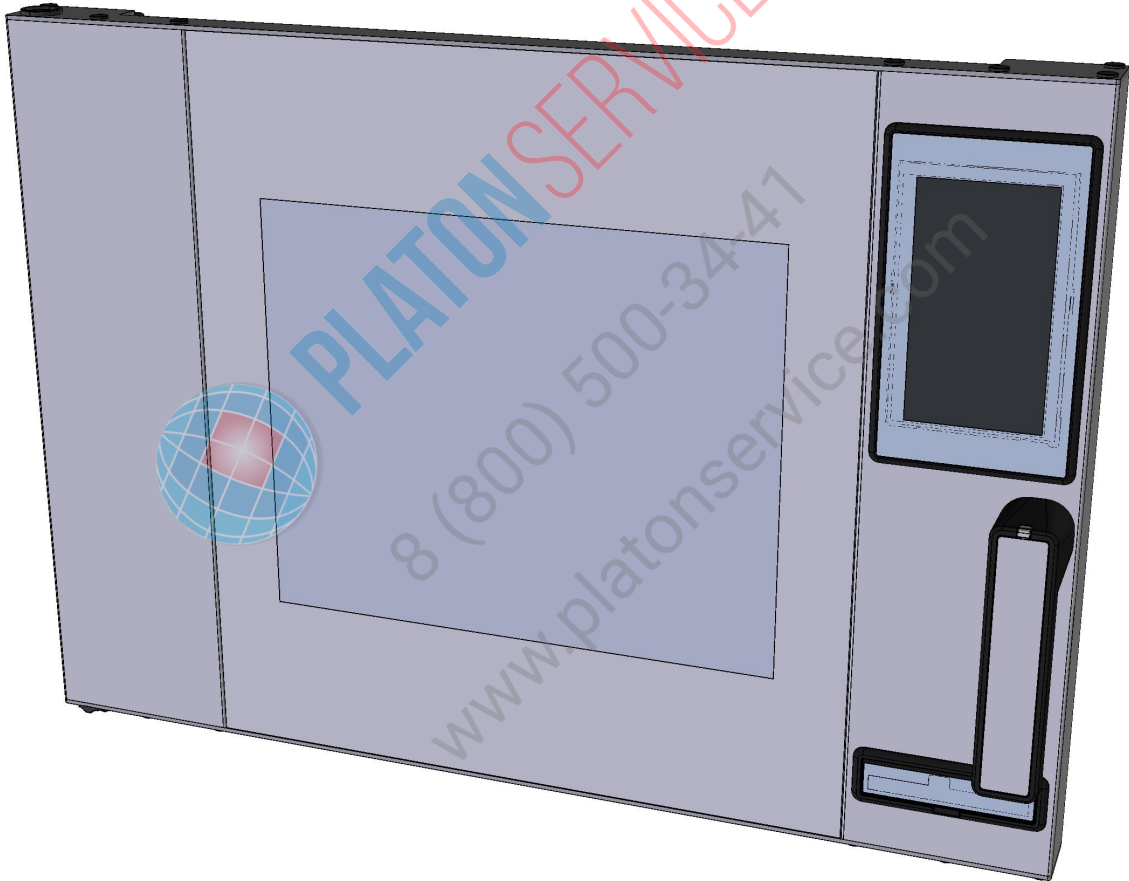

FRONT



ASM2921A/0.D01 - Door

REAR

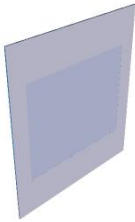

COMPONENT			SPARE PART																																										
Code	Description	Image	Code	Description	Components list																																								
VT1276A	XEVC-0511-E DOOR EXTERNAL GLASS		KVT1276A	0511 EXTERNAL GLASS KIT	<table border="1"> <thead> <tr> <th>Code</th> <th>Description</th> <th>Qty</th> <th>UOM</th> </tr> </thead> <tbody> <tr> <td>0B1166A0</td> <td>EXTERNAL GLASS SUPPORT PROFILE</td> <td>2</td> <td>PZ</td> </tr> <tr> <td>IP1508A1</td> <td>POLYSTYREN E U SHAPED PROFILE 2000X60X60</td> <td>1</td> <td>M</td> </tr> <tr> <td>SL1155A1</td> <td>LOCTITE BICOMPONEN T SILICON</td> <td>150</td> <td>ML</td> </tr> <tr> <td>SL1156A0</td> <td>NOZZLE FOR SILICON GUN</td> <td>1</td> <td>PZ</td> </tr> <tr> <td>VM1059A1</td> <td>HEAT SHRINK FILM H800</td> <td>1.500</td> <td>M</td> </tr> <tr> <td>VT1276A0</td> <td>XEVC-0511-E DOOR EXTERNAL GLASS</td> <td>1</td> <td>PZ</td> </tr> <tr> <td>VT1276A0</td> <td>XEVC-0511-E DOOR EXTERNAL GLASS</td> <td>1</td> <td>PZ</td> </tr> </tbody> </table>	Code	Description	Qty	UOM	0B1166A0	EXTERNAL GLASS SUPPORT PROFILE	2	PZ	IP1508A1	POLYSTYREN E U SHAPED PROFILE 2000X60X60	1	M	SL1155A1	LOCTITE BICOMPONEN T SILICON	150	ML	SL1156A0	NOZZLE FOR SILICON GUN	1	PZ	VM1059A1	HEAT SHRINK FILM H800	1.500	M	VT1276A0	XEVC-0511-E DOOR EXTERNAL GLASS	1	PZ	VT1276A0	XEVC-0511-E DOOR EXTERNAL GLASS	1	PZ								
Code	Description	Qty	UOM																																										
0B1166A0	EXTERNAL GLASS SUPPORT PROFILE	2	PZ																																										
IP1508A1	POLYSTYREN E U SHAPED PROFILE 2000X60X60	1	M																																										
SL1155A1	LOCTITE BICOMPONEN T SILICON	150	ML																																										
SL1156A0	NOZZLE FOR SILICON GUN	1	PZ																																										
VM1059A1	HEAT SHRINK FILM H800	1.500	M																																										
VT1276A0	XEVC-0511-E DOOR EXTERNAL GLASS	1	PZ																																										
VT1276A0	XEVC-0511-E DOOR EXTERNAL GLASS	1	PZ																																										
			KDR1265A	0511 LEFT EXTERNAL DOOR	<table border="1"> <thead> <tr> <th>Code</th> <th>Description</th> <th>Qty</th> <th>UOM</th> </tr> </thead> <tbody> <tr> <td>0B1122A0</td> <td>6 SERIES DOOR LOWER FRAME SHAPE</td> <td>1</td> <td>PZ</td> </tr> <tr> <td>0B1122A1</td> <td></td> <td>1</td> <td>PZ</td> </tr> <tr> <td>0B1166A0</td> <td>EXTERNAL GLASS SUPPORT PROFILE</td> <td>2</td> <td>PZ</td> </tr> <tr> <td>0B1195A0</td> <td>0511 LEFT - DOOR LEFT EXT COLUMN</td> <td>1</td> <td>PZ</td> </tr> <tr> <td>0B1196A1</td> <td>0511 LEFT - DOOR RIGHT INT COLUMN</td> <td>1</td> <td>PZ</td> </tr> <tr> <td>0B1197A1</td> <td>0511 LEFT - DOOR LEFT INT COLUMN</td> <td>1</td> <td>PZ</td> </tr> <tr> <td>0B1206A0</td> <td>0511 LEFT - DOOR RIGHT EXT COLUMN</td> <td>1</td> <td>PZ</td> </tr> <tr> <td>0B1216A0</td> <td>MM DOUBLE GLASS DOOR UPPER BEAM 750</td> <td>1</td> <td>PZ</td> </tr> <tr> <td>0B1217A1</td> <td>MM DOUBLE GLASS DOOR INT UPPER BEAM 750</td> <td>1</td> <td>PZ</td> </tr> </tbody> </table>	Code	Description	Qty	UOM	0B1122A0	6 SERIES DOOR LOWER FRAME SHAPE	1	PZ	0B1122A1		1	PZ	0B1166A0	EXTERNAL GLASS SUPPORT PROFILE	2	PZ	0B1195A0	0511 LEFT - DOOR LEFT EXT COLUMN	1	PZ	0B1196A1	0511 LEFT - DOOR RIGHT INT COLUMN	1	PZ	0B1197A1	0511 LEFT - DOOR LEFT INT COLUMN	1	PZ	0B1206A0	0511 LEFT - DOOR RIGHT EXT COLUMN	1	PZ	0B1216A0	MM DOUBLE GLASS DOOR UPPER BEAM 750	1	PZ	0B1217A1	MM DOUBLE GLASS DOOR INT UPPER BEAM 750	1	PZ
Code	Description	Qty	UOM																																										
0B1122A0	6 SERIES DOOR LOWER FRAME SHAPE	1	PZ																																										
0B1122A1		1	PZ																																										
0B1166A0	EXTERNAL GLASS SUPPORT PROFILE	2	PZ																																										
0B1195A0	0511 LEFT - DOOR LEFT EXT COLUMN	1	PZ																																										
0B1196A1	0511 LEFT - DOOR RIGHT INT COLUMN	1	PZ																																										
0B1197A1	0511 LEFT - DOOR LEFT INT COLUMN	1	PZ																																										
0B1206A0	0511 LEFT - DOOR RIGHT EXT COLUMN	1	PZ																																										
0B1216A0	MM DOUBLE GLASS DOOR UPPER BEAM 750	1	PZ																																										
0B1217A1	MM DOUBLE GLASS DOOR INT UPPER BEAM 750	1	PZ																																										

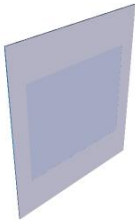

COMPONENT			SPARE PART																																																																		
Code	Description	Image	Code	Description	Components list																																																																
VT1276A	XEVC-0511-E DOOR EXTERNAL GLASS		KDR1265A	0511 LEFT EXTERNAL DOOR	<table border="1"> <thead> <tr> <th>Code</th> <th>Description</th> <th>Qty</th> <th>UOM</th> </tr> </thead> <tbody> <tr> <td>0H7321A0</td> <td>MM STAINLESS STEEL HANDLE COVE</td> <td>1</td> <td>PZ</td> </tr> <tr> <td>CE1052A1</td> <td>CABLE CONNECTION CONTROL - USB MM 750M</td> <td>1</td> <td>PZ</td> </tr> <tr> <td>CE1053B0</td> <td>MM MICROFIT LED BAR POWER SUPPLY CABL</td> <td>1</td> <td>PZ</td> </tr> <tr> <td>CE1285A0</td> <td>EMI ROUND FERRITE MOD.26438015 02</td> <td>1</td> <td>PZ</td> </tr> <tr> <td>CE1290A0</td> <td>EXTRACTABL E FEMALE TERMINAL CPF 5/4</td> <td>1</td> <td>PZ</td> </tr> <tr> <td>CE1455A0</td> <td>TIP END FITTING</td> <td>4</td> <td>PZ</td> </tr> <tr> <td>CE1725A0</td> <td>ROBOTICS SILICON PIPE 4X0,5 MMQ</td> <td>3</td> <td>M</td> </tr> <tr> <td>CE1735A0</td> <td>MINIFIT FEMALE END FITTING</td> <td>4</td> <td>PZ</td> </tr> <tr> <td>CE1755A0</td> <td>4 WAYS MALE MINIFIT CONNECTOR</td> <td>1</td> <td>PZ</td> </tr> <tr> <td>GN1525A0</td> <td>O-RING INT DIAM 9,5 THK 1 NBR 70</td> <td>1</td> <td>PZ</td> </tr> <tr> <td>IP1508A1</td> <td>POLYSTYREN E U SHAPED PROFILE 2000X60X60</td> <td>2</td> <td>M</td> </tr> <tr> <td>LP1019A0</td> <td>6 SERIES L200 LED LIGHT BAR - E415</td> <td>1</td> <td>PZ</td> </tr> <tr> <td>LP1025A0</td> <td>L=415 LED LIGHT BAR COVER</td> <td>1</td> <td>PZ</td> </tr> <tr> <td>RC1200A0</td> <td>ED=4 WIRE D.=0.5 COMPRESSIO N SPRING</td> <td>4</td> <td>PZ</td> </tr> <tr> <td>SL1170A1</td> <td>S57 BLACK SILICON - 310ML CARTRIDGE</td> <td>21</td> <td>ML</td> </tr> </tbody> </table>	Code	Description	Qty	UOM	0H7321A0	MM STAINLESS STEEL HANDLE COVE	1	PZ	CE1052A1	CABLE CONNECTION CONTROL - USB MM 750M	1	PZ	CE1053B0	MM MICROFIT LED BAR POWER SUPPLY CABL	1	PZ	CE1285A0	EMI ROUND FERRITE MOD.26438015 02	1	PZ	CE1290A0	EXTRACTABL E FEMALE TERMINAL CPF 5/4	1	PZ	CE1455A0	TIP END FITTING	4	PZ	CE1725A0	ROBOTICS SILICON PIPE 4X0,5 MMQ	3	M	CE1735A0	MINIFIT FEMALE END FITTING	4	PZ	CE1755A0	4 WAYS MALE MINIFIT CONNECTOR	1	PZ	GN1525A0	O-RING INT DIAM 9,5 THK 1 NBR 70	1	PZ	IP1508A1	POLYSTYREN E U SHAPED PROFILE 2000X60X60	2	M	LP1019A0	6 SERIES L200 LED LIGHT BAR - E415	1	PZ	LP1025A0	L=415 LED LIGHT BAR COVER	1	PZ	RC1200A0	ED=4 WIRE D.=0.5 COMPRESSIO N SPRING	4	PZ	SL1170A1	S57 BLACK SILICON - 310ML CARTRIDGE	21	ML
Code	Description	Qty	UOM																																																																		
0H7321A0	MM STAINLESS STEEL HANDLE COVE	1	PZ																																																																		
CE1052A1	CABLE CONNECTION CONTROL - USB MM 750M	1	PZ																																																																		
CE1053B0	MM MICROFIT LED BAR POWER SUPPLY CABL	1	PZ																																																																		
CE1285A0	EMI ROUND FERRITE MOD.26438015 02	1	PZ																																																																		
CE1290A0	EXTRACTABL E FEMALE TERMINAL CPF 5/4	1	PZ																																																																		
CE1455A0	TIP END FITTING	4	PZ																																																																		
CE1725A0	ROBOTICS SILICON PIPE 4X0,5 MMQ	3	M																																																																		
CE1735A0	MINIFIT FEMALE END FITTING	4	PZ																																																																		
CE1755A0	4 WAYS MALE MINIFIT CONNECTOR	1	PZ																																																																		
GN1525A0	O-RING INT DIAM 9,5 THK 1 NBR 70	1	PZ																																																																		
IP1508A1	POLYSTYREN E U SHAPED PROFILE 2000X60X60	2	M																																																																		
LP1019A0	6 SERIES L200 LED LIGHT BAR - E415	1	PZ																																																																		
LP1025A0	L=415 LED LIGHT BAR COVER	1	PZ																																																																		
RC1200A0	ED=4 WIRE D.=0.5 COMPRESSIO N SPRING	4	PZ																																																																		
SL1170A1	S57 BLACK SILICON - 310ML CARTRIDGE	21	ML																																																																		

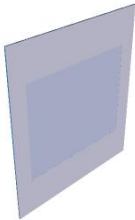

COMPONENT			SPARE PART																																																																																		
Code	Description	Image	Code	Description	Components list																																																																																
VT1276A	XEVC-0511-E DOOR EXTERNAL GLASS		KDR1265A	0511 LEFT EXTERNAL DOOR	<table border="1"> <thead> <tr> <th>Code</th> <th>Description</th> <th>Qty</th> <th>UOM</th> </tr> </thead> <tbody> <tr> <td>VE1030A1</td> <td>MAGNET FOR DOOR MICROSWITC H D=22.9MM</td> <td>2</td> <td>PZ</td> </tr> <tr> <td>VI0239A1</td> <td>SELF-TAPPIN G SCREW 4.2X25 TCB+ INOX</td> <td>4</td> <td>PZ</td> </tr> <tr> <td>VI1034A0</td> <td>STAINLESS STEEL WASHER 8.4X16X1</td> <td>1</td> <td>PZ</td> </tr> <tr> <td>VI1220A1</td> <td>4.2X12 TCB SELF-TAPPIN G SCREW</td> <td>25</td> <td>PZ</td> </tr> <tr> <td>VI1930A0</td> <td>5X25 ST. STEEL SCREW CHIP</td> <td>16</td> <td>PZ</td> </tr> <tr> <td>VI1996A0</td> <td>M5X35 SCREW</td> <td>13</td> <td>PZ</td> </tr> <tr> <td>VI2000A0</td> <td>SCREW M4X22 TCB+ INOX</td> <td>2</td> <td>PZ</td> </tr> <tr> <td>VM1059A1</td> <td>HEAT SHRINK FILM H800</td> <td>1.500</td> <td>M</td> </tr> <tr> <td>VM1182B1</td> <td>E. S. CT BT HANDLE JUNCTION + PIN GUIDE</td> <td>1</td> <td>PZ</td> </tr> <tr> <td>VM1183B0</td> <td>CHEFTOP/BAK ERTOP HANDLE PIN</td> <td>1</td> <td>PZ</td> </tr> <tr> <td>VM1183B1</td> <td>CT BT HANDLE PIN</td> <td>1</td> <td>PZ</td> </tr> <tr> <td>VM1490A0</td> <td>CHEFTOP/BAK ERTOP HANDLE SCREWS COVER</td> <td>2</td> <td>PZ</td> </tr> <tr> <td>VM1630A0</td> <td>INTERNAL GLASS PUSHING CAP</td> <td>1</td> <td>PZ</td> </tr> <tr> <td>VM1631A0</td> <td></td> <td>2</td> <td>PZ</td> </tr> <tr> <td>VM1695A0</td> <td>HANDLE POSITION PIN</td> <td>4</td> <td>PZ</td> </tr> <tr> <td>VM2245A0</td> <td>HANDLE SHAFT WITH LATCH</td> <td>1</td> <td>PZ</td> </tr> <tr> <td>VM2247A0</td> <td>HANDLE SHAFT COVER VM2245-2246</td> <td>1</td> <td>PZ</td> </tr> <tr> <td>VM2248B0</td> <td>CLOSING HANDLE KEY WITH LATCH</td> <td>1</td> <td>PZ</td> </tr> <tr> <td>VM2260A1</td> <td>6 SERIES DOOR UPPER LEFT CAP</td> <td>1</td> <td>PZ</td> </tr> </tbody> </table>	Code	Description	Qty	UOM	VE1030A1	MAGNET FOR DOOR MICROSWITC H D=22.9MM	2	PZ	VI0239A1	SELF-TAPPIN G SCREW 4.2X25 TCB+ INOX	4	PZ	VI1034A0	STAINLESS STEEL WASHER 8.4X16X1	1	PZ	VI1220A1	4.2X12 TCB SELF-TAPPIN G SCREW	25	PZ	VI1930A0	5X25 ST. STEEL SCREW CHIP	16	PZ	VI1996A0	M5X35 SCREW	13	PZ	VI2000A0	SCREW M4X22 TCB+ INOX	2	PZ	VM1059A1	HEAT SHRINK FILM H800	1.500	M	VM1182B1	E. S. CT BT HANDLE JUNCTION + PIN GUIDE	1	PZ	VM1183B0	CHEFTOP/BAK ERTOP HANDLE PIN	1	PZ	VM1183B1	CT BT HANDLE PIN	1	PZ	VM1490A0	CHEFTOP/BAK ERTOP HANDLE SCREWS COVER	2	PZ	VM1630A0	INTERNAL GLASS PUSHING CAP	1	PZ	VM1631A0		2	PZ	VM1695A0	HANDLE POSITION PIN	4	PZ	VM2245A0	HANDLE SHAFT WITH LATCH	1	PZ	VM2247A0	HANDLE SHAFT COVER VM2245-2246	1	PZ	VM2248B0	CLOSING HANDLE KEY WITH LATCH	1	PZ	VM2260A1	6 SERIES DOOR UPPER LEFT CAP	1	PZ
Code	Description	Qty	UOM																																																																																		
VE1030A1	MAGNET FOR DOOR MICROSWITC H D=22.9MM	2	PZ																																																																																		
VI0239A1	SELF-TAPPIN G SCREW 4.2X25 TCB+ INOX	4	PZ																																																																																		
VI1034A0	STAINLESS STEEL WASHER 8.4X16X1	1	PZ																																																																																		
VI1220A1	4.2X12 TCB SELF-TAPPIN G SCREW	25	PZ																																																																																		
VI1930A0	5X25 ST. STEEL SCREW CHIP	16	PZ																																																																																		
VI1996A0	M5X35 SCREW	13	PZ																																																																																		
VI2000A0	SCREW M4X22 TCB+ INOX	2	PZ																																																																																		
VM1059A1	HEAT SHRINK FILM H800	1.500	M																																																																																		
VM1182B1	E. S. CT BT HANDLE JUNCTION + PIN GUIDE	1	PZ																																																																																		
VM1183B0	CHEFTOP/BAK ERTOP HANDLE PIN	1	PZ																																																																																		
VM1183B1	CT BT HANDLE PIN	1	PZ																																																																																		
VM1490A0	CHEFTOP/BAK ERTOP HANDLE SCREWS COVER	2	PZ																																																																																		
VM1630A0	INTERNAL GLASS PUSHING CAP	1	PZ																																																																																		
VM1631A0		2	PZ																																																																																		
VM1695A0	HANDLE POSITION PIN	4	PZ																																																																																		
VM2245A0	HANDLE SHAFT WITH LATCH	1	PZ																																																																																		
VM2247A0	HANDLE SHAFT COVER VM2245-2246	1	PZ																																																																																		
VM2248B0	CLOSING HANDLE KEY WITH LATCH	1	PZ																																																																																		
VM2260A1	6 SERIES DOOR UPPER LEFT CAP	1	PZ																																																																																		



PLATON SERVICE  
8 (800) 500-34-47  
www.platonservice.com



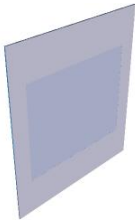

COMPONENT			SPARE PART																																																																										
Code	Description	Image	Code	Description	Components list																																																																								
VT1276A	XEVC-0511-E DOOR EXTERNAL GLASS		KDR1265A	0511 LEFT EXTERNAL DOOR	<table border="1"> <thead> <tr> <th>Code</th> <th>Description</th> <th>Qty</th> <th>UOM</th> </tr> </thead> <tbody> <tr> <td>VM2267A0</td> <td>INTERNAL GLASS LOCKING SYSTEM SLIDER</td> <td>2</td> <td>PZ</td> </tr> <tr> <td>VM2268A0</td> <td>DOOR MAGNET COVER</td> <td>2</td> <td>PZ</td> </tr> <tr> <td>VM2269A0</td> <td>INTERNAL GLASS LOCKING SYSTEM CAP</td> <td>2</td> <td>PZ</td> </tr> <tr> <td>VM2274A0</td> <td>GROOVED BUSHING</td> <td>1</td> <td>PZ</td> </tr> <tr> <td>VM2275A0</td> <td>SMOOTH BUSHING</td> <td>1</td> <td>PZ</td> </tr> <tr> <td>VM2284A0</td> <td>750 SERIES DRIP PROFILE</td> <td>1</td> <td>PZ</td> </tr> <tr> <td>VM2295A0</td> <td>STYLUS PEN FOR MM</td> <td>1</td> <td>PZ</td> </tr> <tr> <td>VM2305A0</td> <td>6 SERIES DOOR CAP FIXING PAWL</td> <td>14</td> <td>PZ</td> </tr> <tr> <td>VM2312A0</td> <td>6 S. DRIP PROFILE DRAIN LEFT PIPE</td> <td>1</td> <td>PZ</td> </tr> <tr> <td>VM2313A0</td> <td>TUBE DX DISCHARGE DRIP MM</td> <td>1</td> <td>PZ</td> </tr> <tr> <td>VM2314A0</td> <td>6 S. DRIP PROFILE CAP</td> <td>1</td> <td>PZ</td> </tr> <tr> <td>VM2315A0</td> <td>MIND.MAPS INTERNAL GLASS CAP SUPPORT</td> <td>1</td> <td>PZ</td> </tr> <tr> <td>VM2371A0</td> <td>DOUBLE GLASS DOOR PUSHING BRACKET</td> <td>2</td> <td>PZ</td> </tr> <tr> <td>VM2371A0</td> <td>DOUBLE GLASS DOOR PUSHING BRACKET</td> <td>2</td> <td>PZ</td> </tr> <tr> <td>VM2383A0</td> <td>LEFT MM DOOR UPPER RIGHT CAP</td> <td>1</td> <td>PZ</td> </tr> <tr> <td>VM2383A0</td> <td>LEFT MM DOOR UPPER RIGHT CAP</td> <td>1</td> <td>PZ</td> </tr> <tr> <td>VM2385A1</td> <td>LEFT MM DOOR UPPER LEFT CAP</td> <td>1</td> <td>PZ</td> </tr> </tbody> </table>	Code	Description	Qty	UOM	VM2267A0	INTERNAL GLASS LOCKING SYSTEM SLIDER	2	PZ	VM2268A0	DOOR MAGNET COVER	2	PZ	VM2269A0	INTERNAL GLASS LOCKING SYSTEM CAP	2	PZ	VM2274A0	GROOVED BUSHING	1	PZ	VM2275A0	SMOOTH BUSHING	1	PZ	VM2284A0	750 SERIES DRIP PROFILE	1	PZ	VM2295A0	STYLUS PEN FOR MM	1	PZ	VM2305A0	6 SERIES DOOR CAP FIXING PAWL	14	PZ	VM2312A0	6 S. DRIP PROFILE DRAIN LEFT PIPE	1	PZ	VM2313A0	TUBE DX DISCHARGE DRIP MM	1	PZ	VM2314A0	6 S. DRIP PROFILE CAP	1	PZ	VM2315A0	MIND.MAPS INTERNAL GLASS CAP SUPPORT	1	PZ	VM2371A0	DOUBLE GLASS DOOR PUSHING BRACKET	2	PZ	VM2371A0	DOUBLE GLASS DOOR PUSHING BRACKET	2	PZ	VM2383A0	LEFT MM DOOR UPPER RIGHT CAP	1	PZ	VM2383A0	LEFT MM DOOR UPPER RIGHT CAP	1	PZ	VM2385A1	LEFT MM DOOR UPPER LEFT CAP	1	PZ
Code	Description	Qty	UOM																																																																										
VM2267A0	INTERNAL GLASS LOCKING SYSTEM SLIDER	2	PZ																																																																										
VM2268A0	DOOR MAGNET COVER	2	PZ																																																																										
VM2269A0	INTERNAL GLASS LOCKING SYSTEM CAP	2	PZ																																																																										
VM2274A0	GROOVED BUSHING	1	PZ																																																																										
VM2275A0	SMOOTH BUSHING	1	PZ																																																																										
VM2284A0	750 SERIES DRIP PROFILE	1	PZ																																																																										
VM2295A0	STYLUS PEN FOR MM	1	PZ																																																																										
VM2305A0	6 SERIES DOOR CAP FIXING PAWL	14	PZ																																																																										
VM2312A0	6 S. DRIP PROFILE DRAIN LEFT PIPE	1	PZ																																																																										
VM2313A0	TUBE DX DISCHARGE DRIP MM	1	PZ																																																																										
VM2314A0	6 S. DRIP PROFILE CAP	1	PZ																																																																										
VM2315A0	MIND.MAPS INTERNAL GLASS CAP SUPPORT	1	PZ																																																																										
VM2371A0	DOUBLE GLASS DOOR PUSHING BRACKET	2	PZ																																																																										
VM2371A0	DOUBLE GLASS DOOR PUSHING BRACKET	2	PZ																																																																										
VM2383A0	LEFT MM DOOR UPPER RIGHT CAP	1	PZ																																																																										
VM2383A0	LEFT MM DOOR UPPER RIGHT CAP	1	PZ																																																																										
VM2385A1	LEFT MM DOOR UPPER LEFT CAP	1	PZ																																																																										

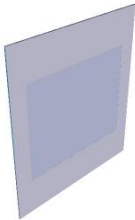

COMPONENT			SPARE PART																																																																																			
Code	Description	Image	Code	Description	Components list																																																																																	
VT1276A	XEVC-0511-E DOOR EXTERNAL GLASS		KDR1265A	0511 LEFT EXTERNAL DOOR	<table border="1"> <thead> <tr> <th>Code</th> <th>Description</th> <th>Qty</th> <th>UOM</th> </tr> </thead> <tbody> <tr> <td>VM2385A1</td> <td>LEFT MM DOOR UPPER LEFT CAP</td> <td>1</td> <td>PZ</td> </tr> <tr> <td>VM2386A1</td> <td>LEFT MM DOOR LOWER LEFT CAP</td> <td>1</td> <td>PZ</td> </tr> <tr> <td>VM2386A1</td> <td>LEFT MM DOOR LOWER LEFT CAP</td> <td>1</td> <td>PZ</td> </tr> <tr> <td>VM2505A0</td> <td>MM PLUS INTERNAL GLASS SUPPORT</td> <td>2</td> <td>PZ</td> </tr> <tr> <td>VM2518A0</td> <td>BOARD COOLING FAN SUPPORT</td> <td>1</td> <td>PZ</td> </tr> <tr> <td>VM2518A0</td> <td>BOARD COOLING FAN SUPPORT</td> <td>1</td> <td>PZ</td> </tr> <tr> <td>VN1179A0</td> <td>CONTROL BOARD COOLING FAN</td> <td>1</td> <td>PZ</td> </tr> <tr> <td>VN1179A0</td> <td>CONTROL BOARD COOLING FAN</td> <td>1</td> <td>PZ</td> </tr> <tr> <td>VN1179A1</td> <td></td> <td>1</td> <td>PZ</td> </tr> <tr> <td>VT1276A0</td> <td>XEVC-0511-E DOOR EXTERNAL GLASS</td> <td></td> <td>1</td> <td>PZ</td> </tr> <tr> <td>VT1276A0</td> <td>XEVC-0511-E DOOR EXTERNAL GLASS</td> <td></td> <td>1</td> <td>PZ</td> </tr> </tbody> </table>	Code	Description	Qty	UOM	VM2385A1	LEFT MM DOOR UPPER LEFT CAP	1	PZ	VM2386A1	LEFT MM DOOR LOWER LEFT CAP	1	PZ	VM2386A1	LEFT MM DOOR LOWER LEFT CAP	1	PZ	VM2505A0	MM PLUS INTERNAL GLASS SUPPORT	2	PZ	VM2518A0	BOARD COOLING FAN SUPPORT	1	PZ	VM2518A0	BOARD COOLING FAN SUPPORT	1	PZ	VN1179A0	CONTROL BOARD COOLING FAN	1	PZ	VN1179A0	CONTROL BOARD COOLING FAN	1	PZ	VN1179A1		1	PZ	VT1276A0	XEVC-0511-E DOOR EXTERNAL GLASS		1	PZ	VT1276A0	XEVC-0511-E DOOR EXTERNAL GLASS		1	PZ	KDR1261A	0511 RIGHT EXTERNAL DOOR	<table border="1"> <thead> <tr> <th>Code</th> <th>Description</th> <th>Qty</th> <th>UOM</th> </tr> </thead> <tbody> <tr> <td>0B1106A0</td> <td>XEVC-0511-E DOOR EXTERNAL LEFT COLUMN</td> <td>1</td> <td>PZ</td> </tr> <tr> <td>0B1107A1</td> <td>XEVC-0511-E LEFT INT DOOR COLUM</td> <td>1</td> <td>PZ</td> </tr> <tr> <td>0B1108A0</td> <td>XEVC-0511-E DOOR EXTERNAL RIGHT COLUM</td> <td>1</td> <td>PZ</td> </tr> <tr> <td>0B1109A1</td> <td>XEVC-0511-E RIGHT INT DOOR COLUM</td> <td>1</td> <td>PZ</td> </tr> <tr> <td>0B1122A0</td> <td>6 SERIES DOOR LOWER FRAME SHAPE</td> <td>1</td> <td>PZ</td> </tr> <tr> <td>0B1122A1</td> <td></td> <td>1</td> <td>PZ</td> </tr> </tbody> </table>	Code	Description	Qty	UOM	0B1106A0	XEVC-0511-E DOOR EXTERNAL LEFT COLUMN	1	PZ	0B1107A1	XEVC-0511-E LEFT INT DOOR COLUM	1	PZ	0B1108A0	XEVC-0511-E DOOR EXTERNAL RIGHT COLUM	1	PZ	0B1109A1	XEVC-0511-E RIGHT INT DOOR COLUM	1	PZ	0B1122A0	6 SERIES DOOR LOWER FRAME SHAPE	1	PZ	0B1122A1		1	PZ
			Code	Description	Qty	UOM																																																																																
VM2385A1	LEFT MM DOOR UPPER LEFT CAP	1	PZ																																																																																			
VM2386A1	LEFT MM DOOR LOWER LEFT CAP	1	PZ																																																																																			
VM2386A1	LEFT MM DOOR LOWER LEFT CAP	1	PZ																																																																																			
VM2505A0	MM PLUS INTERNAL GLASS SUPPORT	2	PZ																																																																																			
VM2518A0	BOARD COOLING FAN SUPPORT	1	PZ																																																																																			
VM2518A0	BOARD COOLING FAN SUPPORT	1	PZ																																																																																			
VN1179A0	CONTROL BOARD COOLING FAN	1	PZ																																																																																			
VN1179A0	CONTROL BOARD COOLING FAN	1	PZ																																																																																			
VN1179A1		1	PZ																																																																																			
VT1276A0	XEVC-0511-E DOOR EXTERNAL GLASS		1	PZ																																																																																		
VT1276A0	XEVC-0511-E DOOR EXTERNAL GLASS		1	PZ																																																																																		
Code	Description	Qty	UOM																																																																																			
0B1106A0	XEVC-0511-E DOOR EXTERNAL LEFT COLUMN	1	PZ																																																																																			
0B1107A1	XEVC-0511-E LEFT INT DOOR COLUM	1	PZ																																																																																			
0B1108A0	XEVC-0511-E DOOR EXTERNAL RIGHT COLUM	1	PZ																																																																																			
0B1109A1	XEVC-0511-E RIGHT INT DOOR COLUM	1	PZ																																																																																			
0B1122A0	6 SERIES DOOR LOWER FRAME SHAPE	1	PZ																																																																																			
0B1122A1		1	PZ																																																																																			

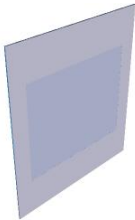
COMPONENT			SPARE PART																																																																		
Code	Description	Image	Code	Description	Components list																																																																
VT1276A	XEVC-0511-E DOOR EXTERNAL GLASS		KDR1261A	0511 RIGHT EXTERNAL DOOR	<table border="1"> <thead> <tr> <th>Code</th> <th>Description</th> <th>Qty</th> <th>UOM</th> </tr> </thead> <tbody> <tr> <td>0B1166A0</td> <td>EXTERNAL GLASS SUPPORT PROFILE</td> <td>2</td> <td>PZ</td> </tr> <tr> <td>0B1216A0</td> <td>MM DOUBLE GLASS DOOR UPPER BEAM 750</td> <td>1</td> <td>PZ</td> </tr> <tr> <td>0B1217A1</td> <td>MM DOUBLE GLASS DOOR INT UPPER BEAM 750</td> <td>1</td> <td>PZ</td> </tr> <tr> <td>0H7321A0</td> <td>MM STAINLESS STEEL HANDLE COVE</td> <td>1</td> <td>PZ</td> </tr> <tr> <td>CE1052A1</td> <td>CABLE CONNECTION CONTROL - USB MM 750M</td> <td>1</td> <td>PZ</td> </tr> <tr> <td>CE1053B0</td> <td>MM MICROFIT LED BAR POWER SUPPLY CABL</td> <td>1</td> <td>PZ</td> </tr> <tr> <td>CE1285A0</td> <td>EMI ROUND FERRITE MOD.26438015 02</td> <td>1</td> <td>PZ</td> </tr> <tr> <td>CE1290A0</td> <td>EXTRACTABL E FEMALE TERMINAL CPF 5/4</td> <td>1</td> <td>PZ</td> </tr> <tr> <td>CE1455A0</td> <td>TIP END FITTING</td> <td>4</td> <td>PZ</td> </tr> <tr> <td>CE1725A0</td> <td>ROBOTICS SILICON PIPE 4X0,5 MMQ</td> <td>3</td> <td>M</td> </tr> <tr> <td>CE1735A0</td> <td>MINIFIT FEMALE END FITTING</td> <td>4</td> <td>PZ</td> </tr> <tr> <td>CE1755A0</td> <td>4 WAYS MALE MINIFIT CONNECTOR</td> <td>1</td> <td>PZ</td> </tr> <tr> <td>GN1525A0</td> <td>O-RING INT DIAM 9,5 THK 1 NBR 70</td> <td>1</td> <td>PZ</td> </tr> <tr> <td>IP1508A1</td> <td>POLYSTYREN E U SHAPED PROFILE 2000X60X60</td> <td>2</td> <td>M</td> </tr> <tr> <td>LP1019A0</td> <td>6 SERIES L200 LED LIGHT BAR - E415</td> <td>1</td> <td>PZ</td> </tr> </tbody> </table>	Code	Description	Qty	UOM	0B1166A0	EXTERNAL GLASS SUPPORT PROFILE	2	PZ	0B1216A0	MM DOUBLE GLASS DOOR UPPER BEAM 750	1	PZ	0B1217A1	MM DOUBLE GLASS DOOR INT UPPER BEAM 750	1	PZ	0H7321A0	MM STAINLESS STEEL HANDLE COVE	1	PZ	CE1052A1	CABLE CONNECTION CONTROL - USB MM 750M	1	PZ	CE1053B0	MM MICROFIT LED BAR POWER SUPPLY CABL	1	PZ	CE1285A0	EMI ROUND FERRITE MOD.26438015 02	1	PZ	CE1290A0	EXTRACTABL E FEMALE TERMINAL CPF 5/4	1	PZ	CE1455A0	TIP END FITTING	4	PZ	CE1725A0	ROBOTICS SILICON PIPE 4X0,5 MMQ	3	M	CE1735A0	MINIFIT FEMALE END FITTING	4	PZ	CE1755A0	4 WAYS MALE MINIFIT CONNECTOR	1	PZ	GN1525A0	O-RING INT DIAM 9,5 THK 1 NBR 70	1	PZ	IP1508A1	POLYSTYREN E U SHAPED PROFILE 2000X60X60	2	M	LP1019A0	6 SERIES L200 LED LIGHT BAR - E415	1	PZ
Code	Description	Qty	UOM																																																																		
0B1166A0	EXTERNAL GLASS SUPPORT PROFILE	2	PZ																																																																		
0B1216A0	MM DOUBLE GLASS DOOR UPPER BEAM 750	1	PZ																																																																		
0B1217A1	MM DOUBLE GLASS DOOR INT UPPER BEAM 750	1	PZ																																																																		
0H7321A0	MM STAINLESS STEEL HANDLE COVE	1	PZ																																																																		
CE1052A1	CABLE CONNECTION CONTROL - USB MM 750M	1	PZ																																																																		
CE1053B0	MM MICROFIT LED BAR POWER SUPPLY CABL	1	PZ																																																																		
CE1285A0	EMI ROUND FERRITE MOD.26438015 02	1	PZ																																																																		
CE1290A0	EXTRACTABL E FEMALE TERMINAL CPF 5/4	1	PZ																																																																		
CE1455A0	TIP END FITTING	4	PZ																																																																		
CE1725A0	ROBOTICS SILICON PIPE 4X0,5 MMQ	3	M																																																																		
CE1735A0	MINIFIT FEMALE END FITTING	4	PZ																																																																		
CE1755A0	4 WAYS MALE MINIFIT CONNECTOR	1	PZ																																																																		
GN1525A0	O-RING INT DIAM 9,5 THK 1 NBR 70	1	PZ																																																																		
IP1508A1	POLYSTYREN E U SHAPED PROFILE 2000X60X60	2	M																																																																		
LP1019A0	6 SERIES L200 LED LIGHT BAR - E415	1	PZ																																																																		

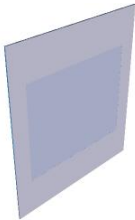

COMPONENT			SPARE PART																																																																														
Code	Description	Image	Code	Description	Components list																																																																												
VT1276A	XEVC-0511-E DOOR EXTERNAL GLASS		KDR1261A	0511 RIGHT EXTERNAL DOOR	<table border="1"> <thead> <tr> <th>Code</th> <th>Description</th> <th>Qty</th> <th>UOM</th> </tr> </thead> <tbody> <tr> <td>LP1025A0</td> <td>L=415 LED LIGHT BAR COVER</td> <td>1</td> <td>PZ</td> </tr> <tr> <td>RC1200A0</td> <td>ED=4 WIRE D.=0.5 COMPRESSIO N SPRING</td> <td>4</td> <td>PZ</td> </tr> <tr> <td>SL1170A1</td> <td>S57 BLACK SILICON - 310ML CARTRIDGE</td> <td>30</td> <td>ML</td> </tr> <tr> <td>VE1030A1</td> <td>MAGNET FOR DOOR MICROSWITC H D=22.9MM</td> <td>2</td> <td>PZ</td> </tr> <tr> <td>VI0239A1</td> <td>SELF-TAPPIN G SCREW 4.2X25 TCB+ INOX</td> <td>4</td> <td>PZ</td> </tr> <tr> <td>VI1034A0</td> <td>STAINLESS STEEL WASHER 8.4X16X1</td> <td>1</td> <td>PZ</td> </tr> <tr> <td>VI1220A1</td> <td>4.2X12 TCB SELF-TAPPIN G SCREW</td> <td>27</td> <td>PZ</td> </tr> <tr> <td>VI1930A0</td> <td>5X25 ST. STEEL SCREW CHIP</td> <td>16</td> <td>PZ</td> </tr> <tr> <td>VI1996A0</td> <td>M5X35 SCREW</td> <td>13</td> <td>PZ</td> </tr> <tr> <td>VI2000A0</td> <td>SCREW M4X22 TCB+ INOX</td> <td>2</td> <td>PZ</td> </tr> <tr> <td>VM1059A1</td> <td>HEAT SHRINK FILM H800</td> <td>1</td> <td>M</td> </tr> <tr> <td>VM1182B1</td> <td>E.S. CT BT HANDLE JUNCTION + PIN GUIDE</td> <td>1</td> <td>PZ</td> </tr> <tr> <td>VM1183B0</td> <td>CHEFTOP/BAK ERTOP HANDLE PIN</td> <td>1</td> <td>PZ</td> </tr> <tr> <td>VM1183B1</td> <td>CT BT HANDLE PIN</td> <td>1</td> <td>PZ</td> </tr> <tr> <td>VM1490A0</td> <td>CHEFTOP/BAK ERTOP HANDLE SCREWS COVER</td> <td>2</td> <td>PZ</td> </tr> <tr> <td>VM1630A0</td> <td>INTERNAL GLASS PUSHING CAP</td> <td>3</td> <td>PZ</td> </tr> <tr> <td>VM1631A0</td> <td></td> <td>2</td> <td>PZ</td> </tr> <tr> <td>VM1695A0</td> <td>HANDLE POSITION PIN</td> <td>4</td> <td>PZ</td> </tr> </tbody> </table>	Code	Description	Qty	UOM	LP1025A0	L=415 LED LIGHT BAR COVER	1	PZ	RC1200A0	ED=4 WIRE D.=0.5 COMPRESSIO N SPRING	4	PZ	SL1170A1	S57 BLACK SILICON - 310ML CARTRIDGE	30	ML	VE1030A1	MAGNET FOR DOOR MICROSWITC H D=22.9MM	2	PZ	VI0239A1	SELF-TAPPIN G SCREW 4.2X25 TCB+ INOX	4	PZ	VI1034A0	STAINLESS STEEL WASHER 8.4X16X1	1	PZ	VI1220A1	4.2X12 TCB SELF-TAPPIN G SCREW	27	PZ	VI1930A0	5X25 ST. STEEL SCREW CHIP	16	PZ	VI1996A0	M5X35 SCREW	13	PZ	VI2000A0	SCREW M4X22 TCB+ INOX	2	PZ	VM1059A1	HEAT SHRINK FILM H800	1	M	VM1182B1	E.S. CT BT HANDLE JUNCTION + PIN GUIDE	1	PZ	VM1183B0	CHEFTOP/BAK ERTOP HANDLE PIN	1	PZ	VM1183B1	CT BT HANDLE PIN	1	PZ	VM1490A0	CHEFTOP/BAK ERTOP HANDLE SCREWS COVER	2	PZ	VM1630A0	INTERNAL GLASS PUSHING CAP	3	PZ	VM1631A0		2	PZ	VM1695A0	HANDLE POSITION PIN	4	PZ
Code	Description	Qty	UOM																																																																														
LP1025A0	L=415 LED LIGHT BAR COVER	1	PZ																																																																														
RC1200A0	ED=4 WIRE D.=0.5 COMPRESSIO N SPRING	4	PZ																																																																														
SL1170A1	S57 BLACK SILICON - 310ML CARTRIDGE	30	ML																																																																														
VE1030A1	MAGNET FOR DOOR MICROSWITC H D=22.9MM	2	PZ																																																																														
VI0239A1	SELF-TAPPIN G SCREW 4.2X25 TCB+ INOX	4	PZ																																																																														
VI1034A0	STAINLESS STEEL WASHER 8.4X16X1	1	PZ																																																																														
VI1220A1	4.2X12 TCB SELF-TAPPIN G SCREW	27	PZ																																																																														
VI1930A0	5X25 ST. STEEL SCREW CHIP	16	PZ																																																																														
VI1996A0	M5X35 SCREW	13	PZ																																																																														
VI2000A0	SCREW M4X22 TCB+ INOX	2	PZ																																																																														
VM1059A1	HEAT SHRINK FILM H800	1	M																																																																														
VM1182B1	E.S. CT BT HANDLE JUNCTION + PIN GUIDE	1	PZ																																																																														
VM1183B0	CHEFTOP/BAK ERTOP HANDLE PIN	1	PZ																																																																														
VM1183B1	CT BT HANDLE PIN	1	PZ																																																																														
VM1490A0	CHEFTOP/BAK ERTOP HANDLE SCREWS COVER	2	PZ																																																																														
VM1630A0	INTERNAL GLASS PUSHING CAP	3	PZ																																																																														
VM1631A0		2	PZ																																																																														
VM1695A0	HANDLE POSITION PIN	4	PZ																																																																														

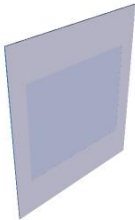

COMPONENT			SPARE PART																																																																														
Code	Description	Image	Code	Description	Components list																																																																												
VT1276A	XEVC-0511-E DOOR EXTERNAL GLASS		KDR1261A	0511 RIGHT EXTERNAL DOOR	<table border="1"> <thead> <tr> <th>Code</th> <th>Description</th> <th>Qty</th> <th>UOM</th> </tr> </thead> <tbody> <tr> <td>VM2245A0</td> <td>HANDLE SHAFT WITH LATCH</td> <td>1</td> <td>PZ</td> </tr> <tr> <td>VM2247A0</td> <td>HANDLE SHAFT COVER VM2245-2246</td> <td>1</td> <td>PZ</td> </tr> <tr> <td>VM2248B0</td> <td>CLOSING HANDLE KEY WITH LATCH</td> <td>1</td> <td>PZ</td> </tr> <tr> <td>VM2259A1</td> <td>6 SERIES DOOR LOWER LEFT CAP</td> <td>1</td> <td>PZ</td> </tr> <tr> <td>VM2260A1</td> <td>6 SERIES DOOR UPPER LEFT CAP</td> <td>1</td> <td>PZ</td> </tr> <tr> <td>VM2261A1</td> <td>6 SERIES DOOR LOWER RIGHT CAP</td> <td>1</td> <td>PZ</td> </tr> <tr> <td>VM2262A1</td> <td>6 SERIES DOOR UPPER RIGHT CAP</td> <td>1</td> <td>PZ</td> </tr> <tr> <td>VM2267A0</td> <td>INTERNAL GLASS LOCKING SYSTEM SLIDER</td> <td>2</td> <td>PZ</td> </tr> <tr> <td>VM2268A0</td> <td>DOOR MAGNET COVER</td> <td>2</td> <td>PZ</td> </tr> <tr> <td>VM2269A0</td> <td>INTERNAL GLASS LOCKING SYSTEM CAP</td> <td>2</td> <td>PZ</td> </tr> <tr> <td>VM2274A0</td> <td>GROOVED BUSHING</td> <td>1</td> <td>PZ</td> </tr> <tr> <td>VM2275A0</td> <td>SMOOTH BUSHING</td> <td>1</td> <td>PZ</td> </tr> <tr> <td>VM2284A0</td> <td>750 SERIES DRIP PROFILE</td> <td>1</td> <td>PZ</td> </tr> <tr> <td>VM2295A0</td> <td>STYLUS PEN FOR MM</td> <td>1</td> <td>PZ</td> </tr> <tr> <td>VM2305A0</td> <td>6 SERIES DOOR CAP FIXING PAWL</td> <td>14</td> <td>PZ</td> </tr> <tr> <td>VM2312A0</td> <td>6 S. DRIP PROFILE DRAIN LEFT PIPE</td> <td>1</td> <td>PZ</td> </tr> <tr> <td>VM2314A0</td> <td>6 S. DRIP PROFILE CAP</td> <td>1</td> <td>PZ</td> </tr> <tr> <td>VM2315A0</td> <td>MIND.MAPS INTERNAL GLASS CAP SUPPORT</td> <td>3</td> <td>PZ</td> </tr> </tbody> </table>	Code	Description	Qty	UOM	VM2245A0	HANDLE SHAFT WITH LATCH	1	PZ	VM2247A0	HANDLE SHAFT COVER VM2245-2246	1	PZ	VM2248B0	CLOSING HANDLE KEY WITH LATCH	1	PZ	VM2259A1	6 SERIES DOOR LOWER LEFT CAP	1	PZ	VM2260A1	6 SERIES DOOR UPPER LEFT CAP	1	PZ	VM2261A1	6 SERIES DOOR LOWER RIGHT CAP	1	PZ	VM2262A1	6 SERIES DOOR UPPER RIGHT CAP	1	PZ	VM2267A0	INTERNAL GLASS LOCKING SYSTEM SLIDER	2	PZ	VM2268A0	DOOR MAGNET COVER	2	PZ	VM2269A0	INTERNAL GLASS LOCKING SYSTEM CAP	2	PZ	VM2274A0	GROOVED BUSHING	1	PZ	VM2275A0	SMOOTH BUSHING	1	PZ	VM2284A0	750 SERIES DRIP PROFILE	1	PZ	VM2295A0	STYLUS PEN FOR MM	1	PZ	VM2305A0	6 SERIES DOOR CAP FIXING PAWL	14	PZ	VM2312A0	6 S. DRIP PROFILE DRAIN LEFT PIPE	1	PZ	VM2314A0	6 S. DRIP PROFILE CAP	1	PZ	VM2315A0	MIND.MAPS INTERNAL GLASS CAP SUPPORT	3	PZ
Code	Description	Qty	UOM																																																																														
VM2245A0	HANDLE SHAFT WITH LATCH	1	PZ																																																																														
VM2247A0	HANDLE SHAFT COVER VM2245-2246	1	PZ																																																																														
VM2248B0	CLOSING HANDLE KEY WITH LATCH	1	PZ																																																																														
VM2259A1	6 SERIES DOOR LOWER LEFT CAP	1	PZ																																																																														
VM2260A1	6 SERIES DOOR UPPER LEFT CAP	1	PZ																																																																														
VM2261A1	6 SERIES DOOR LOWER RIGHT CAP	1	PZ																																																																														
VM2262A1	6 SERIES DOOR UPPER RIGHT CAP	1	PZ																																																																														
VM2267A0	INTERNAL GLASS LOCKING SYSTEM SLIDER	2	PZ																																																																														
VM2268A0	DOOR MAGNET COVER	2	PZ																																																																														
VM2269A0	INTERNAL GLASS LOCKING SYSTEM CAP	2	PZ																																																																														
VM2274A0	GROOVED BUSHING	1	PZ																																																																														
VM2275A0	SMOOTH BUSHING	1	PZ																																																																														
VM2284A0	750 SERIES DRIP PROFILE	1	PZ																																																																														
VM2295A0	STYLUS PEN FOR MM	1	PZ																																																																														
VM2305A0	6 SERIES DOOR CAP FIXING PAWL	14	PZ																																																																														
VM2312A0	6 S. DRIP PROFILE DRAIN LEFT PIPE	1	PZ																																																																														
VM2314A0	6 S. DRIP PROFILE CAP	1	PZ																																																																														
VM2315A0	MIND.MAPS INTERNAL GLASS CAP SUPPORT	3	PZ																																																																														

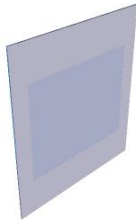
COMPONENT			SPARE PART																																														
Code	Description	Image	Code	Description	Components list																																												
VT1276A	XEVC-0511-E DOOR EXTERNAL GLASS		KDR1261A	0511 RIGHT EXTERNAL DOOR	<table border="1"> <thead> <tr> <th>Code</th> <th>Description</th> <th>Qty</th> <th>UOM</th> </tr> </thead> <tbody> <tr> <td>VM2371A0</td> <td>DOUBLE GLASS DOOR PUSHING BRACKET</td> <td>2</td> <td>PZ</td> </tr> <tr> <td>VM2371A0</td> <td>DOUBLE GLASS DOOR PUSHING BRACKET</td> <td>2</td> <td>PZ</td> </tr> <tr> <td>VM2505A0</td> <td>MM PLUS INTERNAL GLASS SUPPORT</td> <td>2</td> <td>PZ</td> </tr> <tr> <td>VM2518A0</td> <td>BOARD COOLING FAN SUPPORT</td> <td>1</td> <td>PZ</td> </tr> <tr> <td>VM2518A0</td> <td>BOARD COOLING FAN SUPPORT</td> <td>1</td> <td>PZ</td> </tr> <tr> <td>VN1179A0</td> <td>CONTROL BOARD COOLING FAN</td> <td>1</td> <td>PZ</td> </tr> <tr> <td>VN1179A0</td> <td>CONTROL BOARD COOLING FAN</td> <td>1</td> <td>PZ</td> </tr> <tr> <td>VN1179A1</td> <td></td> <td>1</td> <td>PZ</td> </tr> <tr> <td>VT1276A0</td> <td>XEVC-0511-E DOOR EXTERNAL GLASS</td> <td>1</td> <td>PZ</td> </tr> <tr> <td>VT1276A0</td> <td>XEVC-0511-E DOOR EXTERNAL GLASS</td> <td>1</td> <td>PZ</td> </tr> </tbody> </table>	Code	Description	Qty	UOM	VM2371A0	DOUBLE GLASS DOOR PUSHING BRACKET	2	PZ	VM2371A0	DOUBLE GLASS DOOR PUSHING BRACKET	2	PZ	VM2505A0	MM PLUS INTERNAL GLASS SUPPORT	2	PZ	VM2518A0	BOARD COOLING FAN SUPPORT	1	PZ	VM2518A0	BOARD COOLING FAN SUPPORT	1	PZ	VN1179A0	CONTROL BOARD COOLING FAN	1	PZ	VN1179A0	CONTROL BOARD COOLING FAN	1	PZ	VN1179A1		1	PZ	VT1276A0	XEVC-0511-E DOOR EXTERNAL GLASS	1	PZ	VT1276A0	XEVC-0511-E DOOR EXTERNAL GLASS	1	PZ
					Code	Description	Qty	UOM																																									
					VM2371A0	DOUBLE GLASS DOOR PUSHING BRACKET	2	PZ																																									
					VM2371A0	DOUBLE GLASS DOOR PUSHING BRACKET	2	PZ																																									
					VM2505A0	MM PLUS INTERNAL GLASS SUPPORT	2	PZ																																									
					VM2518A0	BOARD COOLING FAN SUPPORT	1	PZ																																									
					VM2518A0	BOARD COOLING FAN SUPPORT	1	PZ																																									
					VN1179A0	CONTROL BOARD COOLING FAN	1	PZ																																									
					VN1179A0	CONTROL BOARD COOLING FAN	1	PZ																																									
					VN1179A1		1	PZ																																									
VT1276A0	XEVC-0511-E DOOR EXTERNAL GLASS	1	PZ																																														
VT1276A0	XEVC-0511-E DOOR EXTERNAL GLASS	1	PZ																																														
MG1083A	MIND.MAPS DOOR COMPLETE HANDLE		KMG1083A	MIND.MAPS SERIES HANDLE KIT	<table border="1"> <thead> <tr> <th>Code</th> <th>Description</th> <th>Qty</th> <th>UOM</th> </tr> </thead> <tbody> <tr> <td>0H7321A0</td> <td>MM STAINLESS STEEL HANDLE COVE</td> <td>1</td> <td>PZ</td> </tr> <tr> <td>RC1200A0</td> <td>ED=4 WIRE D.=0.5 COMPRESSIO N SPRING</td> <td>4</td> <td>PZ</td> </tr> <tr> <td>VI0239A1</td> <td>SELF-TAPPIN G SCREW 4.2X25 TCB+ INOX</td> <td>8</td> <td>PZ</td> </tr> <tr> <td>VI1220A1</td> <td>4,2X12 TCB SELF-TAPPIN G SCREW</td> <td>2</td> <td>PZ</td> </tr> <tr> <td>VM1182B1</td> <td>E.S. CT BT HANDLE JUNCTION + PIN GUIDE</td> <td>1</td> <td>PZ</td> </tr> </tbody> </table>	Code	Description	Qty	UOM	0H7321A0	MM STAINLESS STEEL HANDLE COVE	1	PZ	RC1200A0	ED=4 WIRE D.=0.5 COMPRESSIO N SPRING	4	PZ	VI0239A1	SELF-TAPPIN G SCREW 4.2X25 TCB+ INOX	8	PZ	VI1220A1	4,2X12 TCB SELF-TAPPIN G SCREW	2	PZ	VM1182B1	E.S. CT BT HANDLE JUNCTION + PIN GUIDE	1	PZ																				
					Code	Description	Qty	UOM																																									
					0H7321A0	MM STAINLESS STEEL HANDLE COVE	1	PZ																																									
					RC1200A0	ED=4 WIRE D.=0.5 COMPRESSIO N SPRING	4	PZ																																									
					VI0239A1	SELF-TAPPIN G SCREW 4.2X25 TCB+ INOX	8	PZ																																									
VI1220A1	4,2X12 TCB SELF-TAPPIN G SCREW	2	PZ																																														
VM1182B1	E.S. CT BT HANDLE JUNCTION + PIN GUIDE	1	PZ																																														

COMPONENT			SPARE PART																																														
Code	Description	Image	Code	Description	Components list																																												
MG1083A	MIND.MAPS DOOR COMPLETE HANDLE		KMG1083A	MIND.MAPS SERIES HANDLE KIT	<table border="1"> <thead> <tr> <th>Code</th> <th>Description</th> <th>Qty</th> <th>UOM</th> </tr> </thead> <tbody> <tr> <td>VM1183B0</td> <td>CHEFTOP/BAK ERTOP HANDLE PIN</td> <td>1</td> <td>PZ</td> </tr> <tr> <td>VM1183B1</td> <td>CT BT HANDLE PIN</td> <td>1</td> <td>PZ</td> </tr> <tr> <td>VM1490A0</td> <td>CHEFTOP/BAK ERTOP HANDLE SCREWS COVER</td> <td>2</td> <td>PZ</td> </tr> <tr> <td>VM1695A0</td> <td>HANDLE POSITION PIN</td> <td>4</td> <td>PZ</td> </tr> <tr> <td>VM2245A0</td> <td>HANDLE SHAFT WITH LATCH</td> <td>1</td> <td>PZ</td> </tr> <tr> <td>VM2247A0</td> <td>HANDLE SHAFT COVER VM2245-2246</td> <td>1</td> <td>PZ</td> </tr> <tr> <td>VM2248B0</td> <td>CLOSING HANDLE KEY WITH LATCH</td> <td>1</td> <td>PZ</td> </tr> <tr> <td>VM2295A0</td> <td>STYLUS PEN FOR MM</td> <td>1</td> <td>PZ</td> </tr> </tbody> </table>	Code	Description	Qty	UOM	VM1183B0	CHEFTOP/BAK ERTOP HANDLE PIN	1	PZ	VM1183B1	CT BT HANDLE PIN	1	PZ	VM1490A0	CHEFTOP/BAK ERTOP HANDLE SCREWS COVER	2	PZ	VM1695A0	HANDLE POSITION PIN	4	PZ	VM2245A0	HANDLE SHAFT WITH LATCH	1	PZ	VM2247A0	HANDLE SHAFT COVER VM2245-2246	1	PZ	VM2248B0	CLOSING HANDLE KEY WITH LATCH	1	PZ	VM2295A0	STYLUS PEN FOR MM	1	PZ								
Code	Description	Qty	UOM																																														
VM1183B0	CHEFTOP/BAK ERTOP HANDLE PIN	1	PZ																																														
VM1183B1	CT BT HANDLE PIN	1	PZ																																														
VM1490A0	CHEFTOP/BAK ERTOP HANDLE SCREWS COVER	2	PZ																																														
VM1695A0	HANDLE POSITION PIN	4	PZ																																														
VM2245A0	HANDLE SHAFT WITH LATCH	1	PZ																																														
VM2247A0	HANDLE SHAFT COVER VM2245-2246	1	PZ																																														
VM2248B0	CLOSING HANDLE KEY WITH LATCH	1	PZ																																														
VM2295A0	STYLUS PEN FOR MM	1	PZ																																														
VM2274A	GROOVED BUSHING		KVM2274A	GROOVED PIN BUSHING KIT	<table border="1"> <thead> <tr> <th>Code</th> <th>Description</th> <th>Qty</th> <th>UOM</th> </tr> </thead> <tbody> <tr> <td>VM2274A0</td> <td>GROOVED BUSHING</td> <td>1</td> <td>PZ</td> </tr> </tbody> </table>	Code	Description	Qty	UOM	VM2274A0	GROOVED BUSHING	1	PZ																																				
Code	Description	Qty	UOM																																														
VM2274A0	GROOVED BUSHING	1	PZ																																														
			K0B1126AR	BAKERTOP MM RIGHT DOOR LOWER BEAM KIT	<table border="1"> <thead> <tr> <th>Code</th> <th>Description</th> <th>Qty</th> <th>UOM</th> </tr> </thead> <tbody> <tr> <td>0B1126A0</td> <td>DOOR LOWER FRAME SHAPE 860 MM</td> <td>1</td> <td>PZ</td> </tr> <tr> <td>0B1126A1</td> <td></td> <td>1</td> <td>PZ</td> </tr> <tr> <td>RC1200A0</td> <td>ED=4 WIRE D.=0.5 COMPRESSIO N SPRING</td> <td>2</td> <td>PZ</td> </tr> <tr> <td>V11220A1</td> <td>4,2X12 TCB SELF-TAPPIN G SCREW</td> <td>1</td> <td>PZ</td> </tr> <tr> <td>V11996A0</td> <td>M5X35 SCREW</td> <td>7</td> <td>PZ</td> </tr> <tr> <td>VM1794A0</td> <td>250X4.8 PA66 BLACK CLAMP</td> <td>2</td> <td>PZ</td> </tr> <tr> <td>VM2103A0</td> <td>CLAMP LOCK</td> <td>2</td> <td>PZ</td> </tr> <tr> <td>VM2259A1</td> <td>6 SERIES DOOR LOWER LEFT CAP</td> <td>1</td> <td>PZ</td> </tr> <tr> <td>VM2261A1</td> <td>6 SERIES DOOR LOWER RIGHT CAP</td> <td>1</td> <td>PZ</td> </tr> <tr> <td>VM2267A0</td> <td>INTERNAL GLASS LOCKING SYSTEM SLIDER</td> <td>1</td> <td>PZ</td> </tr> </tbody> </table>	Code	Description	Qty	UOM	0B1126A0	DOOR LOWER FRAME SHAPE 860 MM	1	PZ	0B1126A1		1	PZ	RC1200A0	ED=4 WIRE D.=0.5 COMPRESSIO N SPRING	2	PZ	V11220A1	4,2X12 TCB SELF-TAPPIN G SCREW	1	PZ	V11996A0	M5X35 SCREW	7	PZ	VM1794A0	250X4.8 PA66 BLACK CLAMP	2	PZ	VM2103A0	CLAMP LOCK	2	PZ	VM2259A1	6 SERIES DOOR LOWER LEFT CAP	1	PZ	VM2261A1	6 SERIES DOOR LOWER RIGHT CAP	1	PZ	VM2267A0	INTERNAL GLASS LOCKING SYSTEM SLIDER	1	PZ
Code	Description	Qty	UOM																																														
0B1126A0	DOOR LOWER FRAME SHAPE 860 MM	1	PZ																																														
0B1126A1		1	PZ																																														
RC1200A0	ED=4 WIRE D.=0.5 COMPRESSIO N SPRING	2	PZ																																														
V11220A1	4,2X12 TCB SELF-TAPPIN G SCREW	1	PZ																																														
V11996A0	M5X35 SCREW	7	PZ																																														
VM1794A0	250X4.8 PA66 BLACK CLAMP	2	PZ																																														
VM2103A0	CLAMP LOCK	2	PZ																																														
VM2259A1	6 SERIES DOOR LOWER LEFT CAP	1	PZ																																														
VM2261A1	6 SERIES DOOR LOWER RIGHT CAP	1	PZ																																														
VM2267A0	INTERNAL GLASS LOCKING SYSTEM SLIDER	1	PZ																																														

COMPONENT			SPARE PART																																																																		
Code	Description	Image	Code	Description	Components list																																																																
VM2274A	GROOVED BUSHING		K0B1126AR	BAKERTOP MM RIGHT DOOR LOWER BEAM KIT	<table border="1"> <thead> <tr> <th>Code</th> <th>Description</th> <th>Qty</th> <th>UOM</th> </tr> </thead> <tbody> <tr> <td>VM2269A0</td> <td>INTERNAL GLASS LOCKING SYSTEM CAP</td> <td>1</td> <td>PZ</td> </tr> <tr> <td>VM2274A0</td> <td>GROOVED BUSHING</td> <td>1</td> <td>PZ</td> </tr> <tr> <td>VM2305A0</td> <td>6 SERIES DOOR CAP FIXING PAWL</td> <td>7</td> <td>PZ</td> </tr> </tbody> </table>	Code	Description	Qty	UOM	VM2269A0	INTERNAL GLASS LOCKING SYSTEM CAP	1	PZ	VM2274A0	GROOVED BUSHING	1	PZ	VM2305A0	6 SERIES DOOR CAP FIXING PAWL	7	PZ																																																
Code	Description	Qty	UOM																																																																		
VM2269A0	INTERNAL GLASS LOCKING SYSTEM CAP	1	PZ																																																																		
VM2274A0	GROOVED BUSHING	1	PZ																																																																		
VM2305A0	6 SERIES DOOR CAP FIXING PAWL	7	PZ																																																																		
			K0B1126AL	EU AND 2/1 MM LEFT DOOR LOWER BEAM KIT	<table border="1"> <thead> <tr> <th>Code</th> <th>Description</th> <th>Qty</th> <th>UOM</th> </tr> </thead> <tbody> <tr> <td>0B1126A0</td> <td>DOOR LOWER FRAME SHAPE 860 MM</td> <td>1</td> <td>PZ</td> </tr> <tr> <td>0B1126A1</td> <td></td> <td>1</td> <td>PZ</td> </tr> <tr> <td>RC1200A0</td> <td>ED=4 WIRE D.=0.5 COMPRESSIO N SPRING</td> <td>2</td> <td>PZ</td> </tr> <tr> <td>VI1220A1</td> <td>4,2X12 TCB SELF-TAPPIN G SCREW</td> <td>1</td> <td>PZ</td> </tr> <tr> <td>VI1996A0</td> <td>M5X35 SCREW</td> <td>7</td> <td>PZ</td> </tr> <tr> <td>VM1794A0</td> <td>250X4.8 PA66 BLACK CLAMP</td> <td>2</td> <td>PZ</td> </tr> <tr> <td>VM2103A0</td> <td>CLAMP LOCK</td> <td>2</td> <td>PZ</td> </tr> <tr> <td>VM2267A0</td> <td>INTERNAL GLASS LOCKING SYSTEM SLIDER</td> <td>1</td> <td>PZ</td> </tr> <tr> <td>VM2269A0</td> <td>INTERNAL GLASS LOCKING SYSTEM CAP</td> <td>1</td> <td>PZ</td> </tr> <tr> <td>VM2274A0</td> <td>GROOVED BUSHING</td> <td>1</td> <td>PZ</td> </tr> <tr> <td>VM2305A0</td> <td>6 SERIES DOOR CAP FIXING PAWL</td> <td>7</td> <td>PZ</td> </tr> <tr> <td>VM2384A0</td> <td>LEFT MM DOOR LOWER RIGHT CAP</td> <td>1</td> <td>PZ</td> </tr> <tr> <td>VM2384A0</td> <td>LEFT MM DOOR LOWER RIGHT CAP</td> <td>1</td> <td>PZ</td> </tr> <tr> <td>VM2386A1</td> <td>LEFT MM DOOR LOWER LEFT CAP</td> <td>1</td> <td>PZ</td> </tr> <tr> <td>VM2386A1</td> <td>LEFT MM DOOR LOWER LEFT CAP</td> <td>1</td> <td>PZ</td> </tr> </tbody> </table>	Code	Description	Qty	UOM	0B1126A0	DOOR LOWER FRAME SHAPE 860 MM	1	PZ	0B1126A1		1	PZ	RC1200A0	ED=4 WIRE D.=0.5 COMPRESSIO N SPRING	2	PZ	VI1220A1	4,2X12 TCB SELF-TAPPIN G SCREW	1	PZ	VI1996A0	M5X35 SCREW	7	PZ	VM1794A0	250X4.8 PA66 BLACK CLAMP	2	PZ	VM2103A0	CLAMP LOCK	2	PZ	VM2267A0	INTERNAL GLASS LOCKING SYSTEM SLIDER	1	PZ	VM2269A0	INTERNAL GLASS LOCKING SYSTEM CAP	1	PZ	VM2274A0	GROOVED BUSHING	1	PZ	VM2305A0	6 SERIES DOOR CAP FIXING PAWL	7	PZ	VM2384A0	LEFT MM DOOR LOWER RIGHT CAP	1	PZ	VM2384A0	LEFT MM DOOR LOWER RIGHT CAP	1	PZ	VM2386A1	LEFT MM DOOR LOWER LEFT CAP	1	PZ	VM2386A1	LEFT MM DOOR LOWER LEFT CAP	1	PZ
Code	Description	Qty	UOM																																																																		
0B1126A0	DOOR LOWER FRAME SHAPE 860 MM	1	PZ																																																																		
0B1126A1		1	PZ																																																																		
RC1200A0	ED=4 WIRE D.=0.5 COMPRESSIO N SPRING	2	PZ																																																																		
VI1220A1	4,2X12 TCB SELF-TAPPIN G SCREW	1	PZ																																																																		
VI1996A0	M5X35 SCREW	7	PZ																																																																		
VM1794A0	250X4.8 PA66 BLACK CLAMP	2	PZ																																																																		
VM2103A0	CLAMP LOCK	2	PZ																																																																		
VM2267A0	INTERNAL GLASS LOCKING SYSTEM SLIDER	1	PZ																																																																		
VM2269A0	INTERNAL GLASS LOCKING SYSTEM CAP	1	PZ																																																																		
VM2274A0	GROOVED BUSHING	1	PZ																																																																		
VM2305A0	6 SERIES DOOR CAP FIXING PAWL	7	PZ																																																																		
VM2384A0	LEFT MM DOOR LOWER RIGHT CAP	1	PZ																																																																		
VM2384A0	LEFT MM DOOR LOWER RIGHT CAP	1	PZ																																																																		
VM2386A1	LEFT MM DOOR LOWER LEFT CAP	1	PZ																																																																		
VM2386A1	LEFT MM DOOR LOWER LEFT CAP	1	PZ																																																																		



COMPONENT			SPARE PART																																																																																													
Code	Description	Image	Code	Description	Components list																																																																																											
VM2274A	GROOVED BUSHING		K0B1122AR	CHEFTOP MM RIGHT DOOR LOWER BEAM KIT	<table border="1"> <thead> <tr> <th>Code</th> <th>Description</th> <th>Qty</th> <th>UOM</th> </tr> </thead> <tbody> <tr> <td>0B1122A0</td> <td>6 SERIES DOOR LOWER FRAME SHAPE</td> <td>1</td> <td>PZ</td> </tr> <tr> <td>0B1122A1</td> <td></td> <td>1</td> <td>PZ</td> </tr> <tr> <td>RC1200A0</td> <td>ED=4 WIRE D.=0.5 COMPRESSIO N SPRING</td> <td>2</td> <td>PZ</td> </tr> <tr> <td>VI1220A1</td> <td>4,2X12 TCB SELF-TAPPIN G SCREW</td> <td>1</td> <td>PZ</td> </tr> <tr> <td>VI1996A0</td> <td>M5X35 SCREW</td> <td>7</td> <td>PZ</td> </tr> <tr> <td>VM1794A0</td> <td>250X4.8 PA66 BLACK CLAMP</td> <td>2</td> <td>PZ</td> </tr> <tr> <td>VM2103A0</td> <td>CLAMP LOCK</td> <td>2</td> <td>PZ</td> </tr> <tr> <td>VM2259A1</td> <td>6 SERIES DOOR LOWER LEFT CAP</td> <td>1</td> <td>PZ</td> </tr> <tr> <td>VM2261A1</td> <td>6 SERIES DOOR LOWER RIGHT CAP</td> <td>1</td> <td>PZ</td> </tr> <tr> <td>VM2267A0</td> <td>INTERNAL GLASS LOCKING SYSTEM SLIDER</td> <td>1</td> <td>PZ</td> </tr> <tr> <td>VM2269A0</td> <td>INTERNAL GLASS LOCKING SYSTEM CAP</td> <td>1</td> <td>PZ</td> </tr> <tr> <td>VM2274A0</td> <td>GROOVED BUSHING</td> <td>1</td> <td>PZ</td> </tr> <tr> <td>VM2305A0</td> <td>6 SERIES DOOR CAP FIXING PAWL</td> <td>7</td> <td>PZ</td> </tr> </tbody> </table>	Code	Description	Qty	UOM	0B1122A0	6 SERIES DOOR LOWER FRAME SHAPE	1	PZ	0B1122A1		1	PZ	RC1200A0	ED=4 WIRE D.=0.5 COMPRESSIO N SPRING	2	PZ	VI1220A1	4,2X12 TCB SELF-TAPPIN G SCREW	1	PZ	VI1996A0	M5X35 SCREW	7	PZ	VM1794A0	250X4.8 PA66 BLACK CLAMP	2	PZ	VM2103A0	CLAMP LOCK	2	PZ	VM2259A1	6 SERIES DOOR LOWER LEFT CAP	1	PZ	VM2261A1	6 SERIES DOOR LOWER RIGHT CAP	1	PZ	VM2267A0	INTERNAL GLASS LOCKING SYSTEM SLIDER	1	PZ	VM2269A0	INTERNAL GLASS LOCKING SYSTEM CAP	1	PZ	VM2274A0	GROOVED BUSHING	1	PZ	VM2305A0	6 SERIES DOOR CAP FIXING PAWL	7	PZ	K0B1122AL	CHEFTOP MM LEFT DOOR LOWER BEAM KIT	<table border="1"> <thead> <tr> <th>Code</th> <th>Description</th> <th>Qty</th> <th>UOM</th> </tr> </thead> <tbody> <tr> <td>0B1122A0</td> <td>6 SERIES DOOR LOWER FRAME SHAPE</td> <td>1</td> <td>PZ</td> </tr> <tr> <td>0B1122A1</td> <td></td> <td>1</td> <td>PZ</td> </tr> <tr> <td>RC1200A0</td> <td>ED=4 WIRE D.=0.5 COMPRESSIO N SPRING</td> <td>2</td> <td>PZ</td> </tr> <tr> <td>VI1220A1</td> <td>4,2X12 TCB SELF-TAPPIN G SCREW</td> <td>1</td> <td>PZ</td> </tr> <tr> <td>VI1996A0</td> <td>M5X35 SCREW</td> <td>7</td> <td>PZ</td> </tr> <tr> <td>VM1794A0</td> <td>250X4.8 PA66 BLACK CLAMP</td> <td>2</td> <td>PZ</td> </tr> <tr> <td>VM2103A0</td> <td>CLAMP LOCK</td> <td>2</td> <td>PZ</td> </tr> </tbody> </table>	Code	Description	Qty	UOM	0B1122A0	6 SERIES DOOR LOWER FRAME SHAPE	1	PZ	0B1122A1		1	PZ	RC1200A0	ED=4 WIRE D.=0.5 COMPRESSIO N SPRING	2	PZ	VI1220A1	4,2X12 TCB SELF-TAPPIN G SCREW	1	PZ	VI1996A0	M5X35 SCREW	7	PZ	VM1794A0	250X4.8 PA66 BLACK CLAMP	2	PZ	VM2103A0	CLAMP LOCK	2	PZ
			Code	Description	Qty	UOM																																																																																										
0B1122A0	6 SERIES DOOR LOWER FRAME SHAPE	1	PZ																																																																																													
0B1122A1		1	PZ																																																																																													
RC1200A0	ED=4 WIRE D.=0.5 COMPRESSIO N SPRING	2	PZ																																																																																													
VI1220A1	4,2X12 TCB SELF-TAPPIN G SCREW	1	PZ																																																																																													
VI1996A0	M5X35 SCREW	7	PZ																																																																																													
VM1794A0	250X4.8 PA66 BLACK CLAMP	2	PZ																																																																																													
VM2103A0	CLAMP LOCK	2	PZ																																																																																													
VM2259A1	6 SERIES DOOR LOWER LEFT CAP	1	PZ																																																																																													
VM2261A1	6 SERIES DOOR LOWER RIGHT CAP	1	PZ																																																																																													
VM2267A0	INTERNAL GLASS LOCKING SYSTEM SLIDER	1	PZ																																																																																													
VM2269A0	INTERNAL GLASS LOCKING SYSTEM CAP	1	PZ																																																																																													
VM2274A0	GROOVED BUSHING	1	PZ																																																																																													
VM2305A0	6 SERIES DOOR CAP FIXING PAWL	7	PZ																																																																																													
Code	Description	Qty	UOM																																																																																													
0B1122A0	6 SERIES DOOR LOWER FRAME SHAPE	1	PZ																																																																																													
0B1122A1		1	PZ																																																																																													
RC1200A0	ED=4 WIRE D.=0.5 COMPRESSIO N SPRING	2	PZ																																																																																													
VI1220A1	4,2X12 TCB SELF-TAPPIN G SCREW	1	PZ																																																																																													
VI1996A0	M5X35 SCREW	7	PZ																																																																																													
VM1794A0	250X4.8 PA66 BLACK CLAMP	2	PZ																																																																																													
VM2103A0	CLAMP LOCK	2	PZ																																																																																													

COMPONENT			SPARE PART																																						
Code	Description	Image	Code	Description	Components list																																				
VM2274A	GROOVED BUSHING		K0B1122AL	CHEFTOP MM LEFT DOOR LOWER BEAM KIT	<table border="1"> <thead> <tr> <th>Code</th> <th>Description</th> <th>Qty</th> <th>UOM</th> </tr> </thead> <tbody> <tr> <td>VM2267A0</td> <td>INTERNAL GLASS LOCKING SYSTEM SLIDER</td> <td>1</td> <td>PZ</td> </tr> <tr> <td>VM2269A0</td> <td>INTERNAL GLASS LOCKING SYSTEM CAP</td> <td>1</td> <td>PZ</td> </tr> <tr> <td>VM2274A0</td> <td>GROOVED BUSHING</td> <td>1</td> <td>PZ</td> </tr> <tr> <td>VM2305A0</td> <td>6 SERIES DOOR CAP FIXING PAWL</td> <td>7</td> <td>PZ</td> </tr> <tr> <td>VM2384A0</td> <td>LEFT MM DOOR LOWER RIGHT CAP</td> <td>1</td> <td>PZ</td> </tr> <tr> <td>VM2384A0</td> <td>LEFT MM DOOR LOWER RIGHT CAP</td> <td>1</td> <td>PZ</td> </tr> <tr> <td>VM2386A1</td> <td>LEFT MM DOOR LOWER LEFT CAP</td> <td>1</td> <td>PZ</td> </tr> <tr> <td>VM2386A1</td> <td>LEFT MM DOOR LOWER LEFT CAP</td> <td>1</td> <td>PZ</td> </tr> </tbody> </table>	Code	Description	Qty	UOM	VM2267A0	INTERNAL GLASS LOCKING SYSTEM SLIDER	1	PZ	VM2269A0	INTERNAL GLASS LOCKING SYSTEM CAP	1	PZ	VM2274A0	GROOVED BUSHING	1	PZ	VM2305A0	6 SERIES DOOR CAP FIXING PAWL	7	PZ	VM2384A0	LEFT MM DOOR LOWER RIGHT CAP	1	PZ	VM2384A0	LEFT MM DOOR LOWER RIGHT CAP	1	PZ	VM2386A1	LEFT MM DOOR LOWER LEFT CAP	1	PZ	VM2386A1	LEFT MM DOOR LOWER LEFT CAP	1	PZ
Code	Description	Qty	UOM																																						
VM2267A0	INTERNAL GLASS LOCKING SYSTEM SLIDER	1	PZ																																						
VM2269A0	INTERNAL GLASS LOCKING SYSTEM CAP	1	PZ																																						
VM2274A0	GROOVED BUSHING	1	PZ																																						
VM2305A0	6 SERIES DOOR CAP FIXING PAWL	7	PZ																																						
VM2384A0	LEFT MM DOOR LOWER RIGHT CAP	1	PZ																																						
VM2384A0	LEFT MM DOOR LOWER RIGHT CAP	1	PZ																																						
VM2386A1	LEFT MM DOOR LOWER LEFT CAP	1	PZ																																						
VM2386A1	LEFT MM DOOR LOWER LEFT CAP	1	PZ																																						
VM2305A	6 SERIES DOOR CAP FIXING PAWL		KVM2305A	MM FIXING DOOR THUB SCREWS 10 PCS KIT	<table border="1"> <thead> <tr> <th>Code</th> <th>Description</th> <th>Qty</th> <th>UOM</th> </tr> </thead> <tbody> <tr> <td>VM2305A0</td> <td>6 SERIES DOOR CAP FIXING PAWL</td> <td>10</td> <td>PZ</td> </tr> </tbody> </table>	Code	Description	Qty	UOM	VM2305A0	6 SERIES DOOR CAP FIXING PAWL	10	PZ																												
Code	Description	Qty	UOM																																						
VM2305A0	6 SERIES DOOR CAP FIXING PAWL	10	PZ																																						
VM2259A	6 SERIES DOOR LOWER LEFT CAP		KVM2259A	MIND MAPS DOOR LEFT LOWER CAP KI	<table border="1"> <thead> <tr> <th>Code</th> <th>Description</th> <th>Qty</th> <th>UOM</th> </tr> </thead> <tbody> <tr> <td>VI1996A0</td> <td>M5X35 SCREW</td> <td>3</td> <td>PZ</td> </tr> <tr> <td>VM2259A1</td> <td>6 SERIES DOOR LOWER LEFT CAP</td> <td>1</td> <td>PZ</td> </tr> <tr> <td>VM2305A0</td> <td>6 SERIES DOOR CAP FIXING PAWL</td> <td>3</td> <td>PZ</td> </tr> </tbody> </table>	Code	Description	Qty	UOM	VI1996A0	M5X35 SCREW	3	PZ	VM2259A1	6 SERIES DOOR LOWER LEFT CAP	1	PZ	VM2305A0	6 SERIES DOOR CAP FIXING PAWL	3	PZ																				
Code	Description	Qty	UOM																																						
VI1996A0	M5X35 SCREW	3	PZ																																						
VM2259A1	6 SERIES DOOR LOWER LEFT CAP	1	PZ																																						
VM2305A0	6 SERIES DOOR CAP FIXING PAWL	3	PZ																																						
			K0B1126AR	BAKERTOP MM RIGHT DOOR LOWER BEAM KIT	<table border="1"> <thead> <tr> <th>Code</th> <th>Description</th> <th>Qty</th> <th>UOM</th> </tr> </thead> <tbody> <tr> <td>0B1126A0</td> <td>DOOR LOWER FRAME SHAPE 860 MM</td> <td>1</td> <td>PZ</td> </tr> <tr> <td>0B1126A1</td> <td></td> <td>1</td> <td>PZ</td> </tr> </tbody> </table>	Code	Description	Qty	UOM	0B1126A0	DOOR LOWER FRAME SHAPE 860 MM	1	PZ	0B1126A1		1	PZ																								
Code	Description	Qty	UOM																																						
0B1126A0	DOOR LOWER FRAME SHAPE 860 MM	1	PZ																																						
0B1126A1		1	PZ																																						

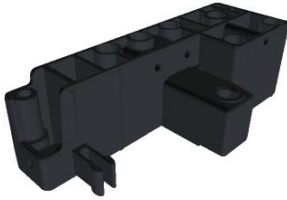

COMPONENT			SPARE PART																																																		
Code	Description	Image	Code	Description	Components list																																																
VM2259A	6 SERIES DOOR LOWER LEFT CAP		K0B1126AR	BAKERTOP MM RIGHT DOOR LOWER BEAM KIT	<table border="1"> <thead> <tr> <th>Code</th> <th>Description</th> <th>Qty</th> <th>UOM</th> </tr> </thead> <tbody> <tr> <td>RC1200A0</td> <td>ED=4 WIRE D.=0.5 COMPRESSIO N SPRING</td> <td>2</td> <td>PZ</td> </tr> <tr> <td>V11220A1</td> <td>4,2X12 TCB SELF-TAPPIN G SCREW</td> <td>1</td> <td>PZ</td> </tr> <tr> <td>V11996A0</td> <td>M5X35 SCREW</td> <td>7</td> <td>PZ</td> </tr> <tr> <td>VM1794A0</td> <td>250X4.8 PA66 BLACK CLAMP</td> <td>2</td> <td>PZ</td> </tr> <tr> <td>VM2103A0</td> <td>CLAMP LOCK</td> <td>2</td> <td>PZ</td> </tr> <tr> <td>VM2259A1</td> <td>6 SERIES DOOR LOWER LEFT CAP</td> <td>1</td> <td>PZ</td> </tr> <tr> <td>VM2261A1</td> <td>6 SERIES DOOR LOWER RIGHT CAP</td> <td>1</td> <td>PZ</td> </tr> <tr> <td>VM2267A0</td> <td>INTERNAL GLASS LOCKING SYSTEM SLIDER</td> <td>1</td> <td>PZ</td> </tr> <tr> <td>VM2269A0</td> <td>INTERNAL GLASS LOCKING SYSTEM CAP</td> <td>1</td> <td>PZ</td> </tr> <tr> <td>VM2274A0</td> <td>GROOVED BUSHING</td> <td>1</td> <td>PZ</td> </tr> <tr> <td>VM2305A0</td> <td>6 SERIES DOOR CAP FIXING PAWL</td> <td>7</td> <td>PZ</td> </tr> </tbody> </table>	Code	Description	Qty	UOM	RC1200A0	ED=4 WIRE D.=0.5 COMPRESSIO N SPRING	2	PZ	V11220A1	4,2X12 TCB SELF-TAPPIN G SCREW	1	PZ	V11996A0	M5X35 SCREW	7	PZ	VM1794A0	250X4.8 PA66 BLACK CLAMP	2	PZ	VM2103A0	CLAMP LOCK	2	PZ	VM2259A1	6 SERIES DOOR LOWER LEFT CAP	1	PZ	VM2261A1	6 SERIES DOOR LOWER RIGHT CAP	1	PZ	VM2267A0	INTERNAL GLASS LOCKING SYSTEM SLIDER	1	PZ	VM2269A0	INTERNAL GLASS LOCKING SYSTEM CAP	1	PZ	VM2274A0	GROOVED BUSHING	1	PZ	VM2305A0	6 SERIES DOOR CAP FIXING PAWL	7	PZ
			Code	Description	Qty	UOM																																															
RC1200A0	ED=4 WIRE D.=0.5 COMPRESSIO N SPRING	2	PZ																																																		
V11220A1	4,2X12 TCB SELF-TAPPIN G SCREW	1	PZ																																																		
V11996A0	M5X35 SCREW	7	PZ																																																		
VM1794A0	250X4.8 PA66 BLACK CLAMP	2	PZ																																																		
VM2103A0	CLAMP LOCK	2	PZ																																																		
VM2259A1	6 SERIES DOOR LOWER LEFT CAP	1	PZ																																																		
VM2261A1	6 SERIES DOOR LOWER RIGHT CAP	1	PZ																																																		
VM2267A0	INTERNAL GLASS LOCKING SYSTEM SLIDER	1	PZ																																																		
VM2269A0	INTERNAL GLASS LOCKING SYSTEM CAP	1	PZ																																																		
VM2274A0	GROOVED BUSHING	1	PZ																																																		
VM2305A0	6 SERIES DOOR CAP FIXING PAWL	7	PZ																																																		
			K0B1126AL	EU AND 2/1 MM LEFT DOOR LOWER BEAM KIT	<table border="1"> <thead> <tr> <th>Code</th> <th>Description</th> <th>Qty</th> <th>UOM</th> </tr> </thead> <tbody> <tr> <td>0B1126A0</td> <td>DOOR LOWER FRAME SHAPE 860 MM</td> <td>1</td> <td>PZ</td> </tr> <tr> <td>0B1126A1</td> <td></td> <td>1</td> <td>PZ</td> </tr> <tr> <td>RC1200A0</td> <td>ED=4 WIRE D.=0.5 COMPRESSIO N SPRING</td> <td>2</td> <td>PZ</td> </tr> <tr> <td>V11220A1</td> <td>4,2X12 TCB SELF-TAPPIN G SCREW</td> <td>1</td> <td>PZ</td> </tr> <tr> <td>V11996A0</td> <td>M5X35 SCREW</td> <td>7</td> <td>PZ</td> </tr> <tr> <td>VM1794A0</td> <td>250X4.8 PA66 BLACK CLAMP</td> <td>2</td> <td>PZ</td> </tr> <tr> <td>VM2103A0</td> <td>CLAMP LOCK</td> <td>2</td> <td>PZ</td> </tr> <tr> <td>VM2267A0</td> <td>INTERNAL GLASS LOCKING SYSTEM SLIDER</td> <td>1</td> <td>PZ</td> </tr> </tbody> </table>	Code	Description	Qty	UOM	0B1126A0	DOOR LOWER FRAME SHAPE 860 MM	1	PZ	0B1126A1		1	PZ	RC1200A0	ED=4 WIRE D.=0.5 COMPRESSIO N SPRING	2	PZ	V11220A1	4,2X12 TCB SELF-TAPPIN G SCREW	1	PZ	V11996A0	M5X35 SCREW	7	PZ	VM1794A0	250X4.8 PA66 BLACK CLAMP	2	PZ	VM2103A0	CLAMP LOCK	2	PZ	VM2267A0	INTERNAL GLASS LOCKING SYSTEM SLIDER	1	PZ												
Code	Description	Qty	UOM																																																		
0B1126A0	DOOR LOWER FRAME SHAPE 860 MM	1	PZ																																																		
0B1126A1		1	PZ																																																		
RC1200A0	ED=4 WIRE D.=0.5 COMPRESSIO N SPRING	2	PZ																																																		
V11220A1	4,2X12 TCB SELF-TAPPIN G SCREW	1	PZ																																																		
V11996A0	M5X35 SCREW	7	PZ																																																		
VM1794A0	250X4.8 PA66 BLACK CLAMP	2	PZ																																																		
VM2103A0	CLAMP LOCK	2	PZ																																																		
VM2267A0	INTERNAL GLASS LOCKING SYSTEM SLIDER	1	PZ																																																		

COMPONENT			SPARE PART																																																							
Code	Description	Image	Code	Description	Components list																																																					
VM2259A	6 SERIES DOOR LOWER LEFT CAP		K0B1126AL	EU AND 2/1 MM LEFT DOOR LOWER BEAM KIT	<table border="1"> <thead> <tr> <th>Code</th> <th>Description</th> <th>Qty</th> <th>UOM</th> </tr> </thead> <tbody> <tr> <td>VM2269A0</td> <td>INTERNAL GLASS LOCKING SYSTEM CAP</td> <td>1</td> <td>PZ</td> </tr> <tr> <td>VM2274A0</td> <td>GROOVED BUSHING</td> <td>1</td> <td>PZ</td> </tr> <tr> <td>VM2305A0</td> <td>6 SERIES DOOR CAP FIXING PAWL</td> <td>7</td> <td>PZ</td> </tr> <tr> <td>VM2384A0</td> <td>LEFT MM DOOR LOWER RIGHT CAP</td> <td>1</td> <td>PZ</td> </tr> <tr> <td>VM2384A0</td> <td>LEFT MM DOOR LOWER RIGHT CAP</td> <td>1</td> <td>PZ</td> </tr> <tr> <td>VM2386A1</td> <td>LEFT MM DOOR LOWER LEFT CAP</td> <td>1</td> <td>PZ</td> </tr> <tr> <td>VM2386A1</td> <td>LEFT MM DOOR LOWER LEFT CAP</td> <td>1</td> <td>PZ</td> </tr> </tbody> </table>	Code	Description	Qty	UOM	VM2269A0	INTERNAL GLASS LOCKING SYSTEM CAP	1	PZ	VM2274A0	GROOVED BUSHING	1	PZ	VM2305A0	6 SERIES DOOR CAP FIXING PAWL	7	PZ	VM2384A0	LEFT MM DOOR LOWER RIGHT CAP	1	PZ	VM2384A0	LEFT MM DOOR LOWER RIGHT CAP	1	PZ	VM2386A1	LEFT MM DOOR LOWER LEFT CAP	1	PZ	VM2386A1	LEFT MM DOOR LOWER LEFT CAP	1	PZ																					
			Code	Description	Qty	UOM																																																				
VM2269A0	INTERNAL GLASS LOCKING SYSTEM CAP	1	PZ																																																							
VM2274A0	GROOVED BUSHING	1	PZ																																																							
VM2305A0	6 SERIES DOOR CAP FIXING PAWL	7	PZ																																																							
VM2384A0	LEFT MM DOOR LOWER RIGHT CAP	1	PZ																																																							
VM2384A0	LEFT MM DOOR LOWER RIGHT CAP	1	PZ																																																							
VM2386A1	LEFT MM DOOR LOWER LEFT CAP	1	PZ																																																							
VM2386A1	LEFT MM DOOR LOWER LEFT CAP	1	PZ																																																							
K0B1122AR	CHEFTOP MM RIGHT DOOR LOWER BEAM KIT	<table border="1"> <thead> <tr> <th>Code</th> <th>Description</th> <th>Qty</th> <th>UOM</th> </tr> </thead> <tbody> <tr> <td>0B1122A0</td> <td>6 SERIES DOOR LOWER FRAME SHAPE</td> <td>1</td> <td>PZ</td> </tr> <tr> <td>0B1122A1</td> <td></td> <td>1</td> <td>PZ</td> </tr> <tr> <td>RC1200A0</td> <td>ED=4 WIRE D.=0.5 COMPRESSIO N SPRING</td> <td>2</td> <td>PZ</td> </tr> <tr> <td>VI1220A1</td> <td>4,2X12 TCB SELF-TAPPIN G SCREW</td> <td>1</td> <td>PZ</td> </tr> <tr> <td>VI1996A0</td> <td>M5X35 SCREW</td> <td>7</td> <td>PZ</td> </tr> <tr> <td>VM1794A0</td> <td>250X4.8 PA66 BLACK CLAMP</td> <td>2</td> <td>PZ</td> </tr> <tr> <td>VM2103A0</td> <td>CLAMP LOCK</td> <td>2</td> <td>PZ</td> </tr> <tr> <td>VM2259A1</td> <td>6 SERIES DOOR LOWER LEFT CAP</td> <td>1</td> <td>PZ</td> </tr> <tr> <td>VM2261A1</td> <td>6 SERIES DOOR LOWER RIGHT CAP</td> <td>1</td> <td>PZ</td> </tr> <tr> <td>VM2267A0</td> <td>INTERNAL GLASS LOCKING SYSTEM SLIDER</td> <td>1</td> <td>PZ</td> </tr> <tr> <td>VM2269A0</td> <td>INTERNAL GLASS LOCKING SYSTEM CAP</td> <td>1</td> <td>PZ</td> </tr> <tr> <td>VM2274A0</td> <td>GROOVED BUSHING</td> <td>1</td> <td>PZ</td> </tr> <tr> <td>VM2305A0</td> <td>6 SERIES DOOR CAP FIXING PAWL</td> <td>7</td> <td>PZ</td> </tr> </tbody> </table>	Code	Description	Qty	UOM	0B1122A0	6 SERIES DOOR LOWER FRAME SHAPE	1	PZ	0B1122A1		1	PZ	RC1200A0	ED=4 WIRE D.=0.5 COMPRESSIO N SPRING	2	PZ	VI1220A1	4,2X12 TCB SELF-TAPPIN G SCREW	1	PZ	VI1996A0	M5X35 SCREW	7	PZ	VM1794A0	250X4.8 PA66 BLACK CLAMP	2	PZ	VM2103A0	CLAMP LOCK	2	PZ	VM2259A1	6 SERIES DOOR LOWER LEFT CAP	1	PZ	VM2261A1	6 SERIES DOOR LOWER RIGHT CAP	1	PZ	VM2267A0	INTERNAL GLASS LOCKING SYSTEM SLIDER	1	PZ	VM2269A0	INTERNAL GLASS LOCKING SYSTEM CAP	1	PZ	VM2274A0	GROOVED BUSHING	1	PZ	VM2305A0	6 SERIES DOOR CAP FIXING PAWL	7	PZ
Code	Description	Qty	UOM																																																							
0B1122A0	6 SERIES DOOR LOWER FRAME SHAPE	1	PZ																																																							
0B1122A1		1	PZ																																																							
RC1200A0	ED=4 WIRE D.=0.5 COMPRESSIO N SPRING	2	PZ																																																							
VI1220A1	4,2X12 TCB SELF-TAPPIN G SCREW	1	PZ																																																							
VI1996A0	M5X35 SCREW	7	PZ																																																							
VM1794A0	250X4.8 PA66 BLACK CLAMP	2	PZ																																																							
VM2103A0	CLAMP LOCK	2	PZ																																																							
VM2259A1	6 SERIES DOOR LOWER LEFT CAP	1	PZ																																																							
VM2261A1	6 SERIES DOOR LOWER RIGHT CAP	1	PZ																																																							
VM2267A0	INTERNAL GLASS LOCKING SYSTEM SLIDER	1	PZ																																																							
VM2269A0	INTERNAL GLASS LOCKING SYSTEM CAP	1	PZ																																																							
VM2274A0	GROOVED BUSHING	1	PZ																																																							
VM2305A0	6 SERIES DOOR CAP FIXING PAWL	7	PZ																																																							

COMPONENT			SPARE PART																																																																		
Code	Description	Image	Code	Description	Components list																																																																
VM2259A	6 SERIES DOOR LOWER LEFT CAP		K0B1122AL	CHEFTOP MM LEFT DOOR LOWER BEAM KIT	<table border="1"> <thead> <tr> <th>Code</th> <th>Description</th> <th>Qty</th> <th>UOM</th> </tr> </thead> <tbody> <tr> <td>0B1122A0</td> <td>6 SERIES DOOR LOWER FRAME SHAPE</td> <td>1</td> <td>PZ</td> </tr> <tr> <td>0B1122A1</td> <td></td> <td>1</td> <td>PZ</td> </tr> <tr> <td>RC1200A0</td> <td>ED=4 WIRE D.=0.5 COMPRESSIO N SPRING</td> <td>2</td> <td>PZ</td> </tr> <tr> <td>VI1220A1</td> <td>4,2X12 TCB SELF-TAPPIN G SCREW</td> <td>1</td> <td>PZ</td> </tr> <tr> <td>VI1996A0</td> <td>M5X35 SCREW</td> <td>7</td> <td>PZ</td> </tr> <tr> <td>VM1794A0</td> <td>250X4.8 PA66 BLACK CLAMP</td> <td>2</td> <td>PZ</td> </tr> <tr> <td>VM2103A0</td> <td>CLAMP LOCK</td> <td>2</td> <td>PZ</td> </tr> <tr> <td>VM2267A0</td> <td>INTERNAL GLASS LOCKING SYSTEM SLIDER</td> <td>1</td> <td>PZ</td> </tr> <tr> <td>VM2269A0</td> <td>INTERNAL GLASS LOCKING SYSTEM CAP</td> <td>1</td> <td>PZ</td> </tr> <tr> <td>VM2274A0</td> <td>GROOVED BUSHING</td> <td>1</td> <td>PZ</td> </tr> <tr> <td>VM2305A0</td> <td>6 SERIES DOOR CAP FIXING PAWL</td> <td>7</td> <td>PZ</td> </tr> <tr> <td>VM2384A0</td> <td>LEFT MM DOOR LOWER RIGHT CAP</td> <td>1</td> <td>PZ</td> </tr> <tr> <td>VM2384A0</td> <td>LEFT MM DOOR LOWER RIGHT CAP</td> <td>1</td> <td>PZ</td> </tr> <tr> <td>VM2386A1</td> <td>LEFT MM DOOR LOWER LEFT CAP</td> <td>1</td> <td>PZ</td> </tr> <tr> <td>VM2386A1</td> <td>LEFT MM DOOR LOWER LEFT CAP</td> <td>1</td> <td>PZ</td> </tr> </tbody> </table>	Code	Description	Qty	UOM	0B1122A0	6 SERIES DOOR LOWER FRAME SHAPE	1	PZ	0B1122A1		1	PZ	RC1200A0	ED=4 WIRE D.=0.5 COMPRESSIO N SPRING	2	PZ	VI1220A1	4,2X12 TCB SELF-TAPPIN G SCREW	1	PZ	VI1996A0	M5X35 SCREW	7	PZ	VM1794A0	250X4.8 PA66 BLACK CLAMP	2	PZ	VM2103A0	CLAMP LOCK	2	PZ	VM2267A0	INTERNAL GLASS LOCKING SYSTEM SLIDER	1	PZ	VM2269A0	INTERNAL GLASS LOCKING SYSTEM CAP	1	PZ	VM2274A0	GROOVED BUSHING	1	PZ	VM2305A0	6 SERIES DOOR CAP FIXING PAWL	7	PZ	VM2384A0	LEFT MM DOOR LOWER RIGHT CAP	1	PZ	VM2384A0	LEFT MM DOOR LOWER RIGHT CAP	1	PZ	VM2386A1	LEFT MM DOOR LOWER LEFT CAP	1	PZ	VM2386A1	LEFT MM DOOR LOWER LEFT CAP	1	PZ
					Code	Description	Qty	UOM																																																													
0B1122A0	6 SERIES DOOR LOWER FRAME SHAPE	1	PZ																																																																		
0B1122A1		1	PZ																																																																		
RC1200A0	ED=4 WIRE D.=0.5 COMPRESSIO N SPRING	2	PZ																																																																		
VI1220A1	4,2X12 TCB SELF-TAPPIN G SCREW	1	PZ																																																																		
VI1996A0	M5X35 SCREW	7	PZ																																																																		
VM1794A0	250X4.8 PA66 BLACK CLAMP	2	PZ																																																																		
VM2103A0	CLAMP LOCK	2	PZ																																																																		
VM2267A0	INTERNAL GLASS LOCKING SYSTEM SLIDER	1	PZ																																																																		
VM2269A0	INTERNAL GLASS LOCKING SYSTEM CAP	1	PZ																																																																		
VM2274A0	GROOVED BUSHING	1	PZ																																																																		
VM2305A0	6 SERIES DOOR CAP FIXING PAWL	7	PZ																																																																		
VM2384A0	LEFT MM DOOR LOWER RIGHT CAP	1	PZ																																																																		
VM2384A0	LEFT MM DOOR LOWER RIGHT CAP	1	PZ																																																																		
VM2386A1	LEFT MM DOOR LOWER LEFT CAP	1	PZ																																																																		
VM2386A1	LEFT MM DOOR LOWER LEFT CAP	1	PZ																																																																		
VM2305A	6 SERIES DOOR CAP FIXING PAWL		KVM2305A	MM FIXING DOOR THUB SCREWS 10 PCS KIT	<table border="1"> <thead> <tr> <th>Code</th> <th>Description</th> <th>Qty</th> <th>UOM</th> </tr> </thead> <tbody> <tr> <td>VM2305A0</td> <td>6 SERIES DOOR CAP FIXING PAWL</td> <td>10</td> <td>PZ</td> </tr> </tbody> </table>	Code	Description	Qty	UOM	VM2305A0	6 SERIES DOOR CAP FIXING PAWL	10	PZ																																																								
Code	Description	Qty	UOM																																																																		
VM2305A0	6 SERIES DOOR CAP FIXING PAWL	10	PZ																																																																		



COMPONENT			SPARE PART										
Code	Description	Image	Code	Description	Components list								
VM2275A	SMOOTH BUSHING		KVM2275A	SMOOTH PIN BUSHING KIT	<table border="1"> <thead> <tr> <th>Code</th> <th>Description</th> <th>Qty</th> <th>UOM</th> </tr> </thead> <tbody> <tr> <td>VM2275A0</td> <td>SMOOTH BUSHING</td> <td>1</td> <td>PZ</td> </tr> </tbody> </table>	Code	Description	Qty	UOM	VM2275A0	SMOOTH BUSHING	1	PZ
Code	Description	Qty	UOM										
VM2275A0	SMOOTH BUSHING	1	PZ										
VM2260A	6 SERIES DOOR UPPER LEFT CAP		KVM2260A	MIND.MAPS DOOR LEFT UPPER CAP KI	<table border="1"> <thead> <tr> <th>Code</th> <th>Description</th> <th>Qty</th> <th>UOM</th> </tr> </thead> <tbody> <tr> <td>VM2260A1</td> <td>6 SERIES DOOR UPPER LEFT CAP</td> <td>1</td> <td>PZ</td> </tr> </tbody> </table>	Code	Description	Qty	UOM	VM2260A1	6 SERIES DOOR UPPER LEFT CAP	1	PZ
Code	Description	Qty	UOM										
VM2260A1	6 SERIES DOOR UPPER LEFT CAP	1	PZ										
VM2305A	6 SERIES DOOR CAP FIXING PAWL		KVM2305A	MM FIXING DOOR THUB SCREWS 10 PCS KIT	<table border="1"> <thead> <tr> <th>Code</th> <th>Description</th> <th>Qty</th> <th>UOM</th> </tr> </thead> <tbody> <tr> <td>VM2305A0</td> <td>6 SERIES DOOR CAP FIXING PAWL</td> <td>10</td> <td>PZ</td> </tr> </tbody> </table>	Code	Description	Qty	UOM	VM2305A0	6 SERIES DOOR CAP FIXING PAWL	10	PZ
Code	Description	Qty	UOM										
VM2305A0	6 SERIES DOOR CAP FIXING PAWL	10	PZ										
VM2267A	INTERNAL GLASS LOCKING SYSTEM SLIDER		VM2267A0	INTERNAL GLASS LOCKING SYSTEM SLIDER									
VM2269A	INTERNAL GLASS LOCKING SYSTEM CAP		KVM2269A	INNER GLASS FIXING CAP KIT	<table border="1"> <thead> <tr> <th>Code</th> <th>Description</th> <th>Qty</th> <th>UOM</th> </tr> </thead> <tbody> <tr> <td>VM2269A0</td> <td>INTERNAL GLASS LOCKING SYSTEM CAP</td> <td>2</td> <td>PZ</td> </tr> </tbody> </table>	Code	Description	Qty	UOM	VM2269A0	INTERNAL GLASS LOCKING SYSTEM CAP	2	PZ
Code	Description	Qty	UOM										
VM2269A0	INTERNAL GLASS LOCKING SYSTEM CAP	2	PZ										

COMPONENT			SPARE PART										
Code	Description	Image	Code	Description	Components list								
VE1030A	MAGNET FOR DOOR MICROSWITCH D=22,9MM		KVE1030A	2 PCS MAGNET KIT FOR DOOR SWITCH	<table border="1"> <thead> <tr> <th>Code</th> <th>Description</th> <th>Qty</th> <th>UOM</th> </tr> </thead> <tbody> <tr> <td>VE1030A1</td> <td>MAGNET FOR DOOR MICROSWITCH H D=22,9MM</td> <td>2</td> <td>PZ</td> </tr> </tbody> </table>	Code	Description	Qty	UOM	VE1030A1	MAGNET FOR DOOR MICROSWITCH H D=22,9MM	2	PZ
					Code	Description	Qty	UOM					
					VE1030A1	MAGNET FOR DOOR MICROSWITCH H D=22,9MM	2	PZ					
<table border="1"> <thead> <tr> <th>Code</th> <th>Description</th> <th>Qty</th> <th>UOM</th> </tr> </thead> <tbody> <tr> <td>VE1020A2</td> <td>MAGNETIC DOOR MICROSWITCH</td> <td>1</td> <td>PZ</td> </tr> </tbody> </table>	Code	Description	Qty	UOM	VE1020A2	MAGNETIC DOOR MICROSWITCH	1	PZ					
Code	Description	Qty	UOM										
VE1020A2	MAGNETIC DOOR MICROSWITCH	1	PZ										
<table border="1"> <thead> <tr> <th>Code</th> <th>Description</th> <th>Qty</th> <th>UOM</th> </tr> </thead> <tbody> <tr> <td>VE1030A1</td> <td>MAGNET FOR DOOR MICROSWITCH H D=22,9MM</td> <td>4</td> <td>PZ</td> </tr> </tbody> </table>	Code	Description	Qty	UOM	VE1030A1	MAGNET FOR DOOR MICROSWITCH H D=22,9MM	4	PZ					
Code	Description	Qty	UOM										
VE1030A1	MAGNET FOR DOOR MICROSWITCH H D=22,9MM	4	PZ										
VM2268A	DOOR MAGNET COVER		KVM2268A	DOOR MAGNET COVER KIT	<table border="1"> <thead> <tr> <th>Code</th> <th>Description</th> <th>Qty</th> <th>UOM</th> </tr> </thead> <tbody> <tr> <td>VM2268A0</td> <td>DOOR MAGNET COVER</td> <td>1</td> <td>PZ</td> </tr> </tbody> </table>	Code	Description	Qty	UOM	VM2268A0	DOOR MAGNET COVER	1	PZ
Code	Description	Qty	UOM										
VM2268A0	DOOR MAGNET COVER	1	PZ										
VM2262A	6 SERIES DOOR UPPER RIGHT CAP		KVM2262A	MIND.MAPS DOOR RIGHT UPPER CAP KIT	<table border="1"> <thead> <tr> <th>Code</th> <th>Description</th> <th>Qty</th> <th>UOM</th> </tr> </thead> <tbody> <tr> <td>VM2262A1</td> <td>6 SERIES DOOR UPPER RIGHT CAP</td> <td>1</td> <td>PZ</td> </tr> </tbody> </table>	Code	Description	Qty	UOM	VM2262A1	6 SERIES DOOR UPPER RIGHT CAP	1	PZ
Code	Description	Qty	UOM										
VM2262A1	6 SERIES DOOR UPPER RIGHT CAP	1	PZ										
VM2305A	6 SERIES DOOR CAP FIXING PAWL		KVM2305A	MM FIXING DOOR THUB SCREWS 10 PCS KIT	<table border="1"> <thead> <tr> <th>Code</th> <th>Description</th> <th>Qty</th> <th>UOM</th> </tr> </thead> <tbody> <tr> <td>VM2305A0</td> <td>6 SERIES DOOR CAP FIXING PAWL</td> <td>10</td> <td>PZ</td> </tr> </tbody> </table>	Code	Description	Qty	UOM	VM2305A0	6 SERIES DOOR CAP FIXING PAWL	10	PZ
Code	Description	Qty	UOM										
VM2305A0	6 SERIES DOOR CAP FIXING PAWL	10	PZ										
VM2267A	INTERNAL GLASS LOCKING SYSTEM SLIDER		VM2267A0	INTERNAL GLASS LOCKING SYSTEM SLIDER									

COMPONENT			SPARE PART																		
Code	Description	Image	Code	Description	Components list																
VM2269A	INTERNAL GLASS LOCKING SYSTEM CAP		KVM2269A	INNER GLASS FIXING CAP KIT	<table border="1"> <thead> <tr> <th>Code</th> <th>Description</th> <th>Qty</th> <th>UOM</th> </tr> </thead> <tbody> <tr> <td>VM2269A0</td> <td>INTERNAL GLASS LOCKING SYSTEM CAP</td> <td>2</td> <td>PZ</td> </tr> </tbody> </table>	Code	Description	Qty	UOM	VM2269A0	INTERNAL GLASS LOCKING SYSTEM CAP	2	PZ								
Code	Description	Qty	UOM																		
VM2269A0	INTERNAL GLASS LOCKING SYSTEM CAP	2	PZ																		
VE1030A	MAGNET FOR DOOR MICROSWITCH D=22,9MM		KVE1030A	2 PCS MAGNET KIT FOR DOOR SWITCH	<table border="1"> <thead> <tr> <th>Code</th> <th>Description</th> <th>Qty</th> <th>UOM</th> </tr> </thead> <tbody> <tr> <td>VE1030A1</td> <td>MAGNET FOR DOOR MICROSWITCH H D=22,9MM</td> <td>2</td> <td>PZ</td> </tr> </tbody> </table>	Code	Description	Qty	UOM	VE1030A1	MAGNET FOR DOOR MICROSWITCH H D=22,9MM	2	PZ								
Code	Description	Qty	UOM																		
VE1030A1	MAGNET FOR DOOR MICROSWITCH H D=22,9MM	2	PZ																		
			KVE1020A	MICROSWITCH KIT	<table border="1"> <thead> <tr> <th>Code</th> <th>Description</th> <th>Qty</th> <th>UOM</th> </tr> </thead> <tbody> <tr> <td>VE1020A2</td> <td>MAGNETIC DOOR MICROSWITCH</td> <td>1</td> <td>PZ</td> </tr> <tr> <td>VE1030A1</td> <td>MAGNET FOR DOOR MICROSWITCH H D=22,9MM</td> <td>4</td> <td>PZ</td> </tr> </tbody> </table>	Code	Description	Qty	UOM	VE1020A2	MAGNETIC DOOR MICROSWITCH	1	PZ	VE1030A1	MAGNET FOR DOOR MICROSWITCH H D=22,9MM	4	PZ				
Code	Description	Qty	UOM																		
VE1020A2	MAGNETIC DOOR MICROSWITCH	1	PZ																		
VE1030A1	MAGNET FOR DOOR MICROSWITCH H D=22,9MM	4	PZ																		
VM2268A	DOOR MAGNET COVER		KVM2268A	DOOR MAGNET COVER KIT	<table border="1"> <thead> <tr> <th>Code</th> <th>Description</th> <th>Qty</th> <th>UOM</th> </tr> </thead> <tbody> <tr> <td>VM2268A0</td> <td>DOOR MAGNET COVER</td> <td>1</td> <td>PZ</td> </tr> </tbody> </table>	Code	Description	Qty	UOM	VM2268A0	DOOR MAGNET COVER	1	PZ								
Code	Description	Qty	UOM																		
VM2268A0	DOOR MAGNET COVER	1	PZ																		
VM2261A	6 SERIES DOOR LOWER RIGHT CAP		KVM2261A	MIND.MAPS DOOR RIGHT LOWER CAP KIT	<table border="1"> <thead> <tr> <th>Code</th> <th>Description</th> <th>Qty</th> <th>UOM</th> </tr> </thead> <tbody> <tr> <td>VI1996A0</td> <td>M5X35 SCREW</td> <td>3</td> <td>PZ</td> </tr> <tr> <td>VM2261A1</td> <td>6 SERIES DOOR LOWER RIGHT CAP</td> <td>1</td> <td>PZ</td> </tr> <tr> <td>VM2305A0</td> <td>6 SERIES DOOR CAP FIXING PAWL</td> <td>3</td> <td>PZ</td> </tr> </tbody> </table>	Code	Description	Qty	UOM	VI1996A0	M5X35 SCREW	3	PZ	VM2261A1	6 SERIES DOOR LOWER RIGHT CAP	1	PZ	VM2305A0	6 SERIES DOOR CAP FIXING PAWL	3	PZ
Code	Description	Qty	UOM																		
VI1996A0	M5X35 SCREW	3	PZ																		
VM2261A1	6 SERIES DOOR LOWER RIGHT CAP	1	PZ																		
VM2305A0	6 SERIES DOOR CAP FIXING PAWL	3	PZ																		
			K0B1126AR	BAKERTOP MM RIGHT DOOR LOWER BEAM KIT	<table border="1"> <thead> <tr> <th>Code</th> <th>Description</th> <th>Qty</th> <th>UOM</th> </tr> </thead> <tbody> <tr> <td>0B1126A0</td> <td>DOOR LOWER FRAME SHAPE 860 MM</td> <td>1</td> <td>PZ</td> </tr> <tr> <td>0B1126A1</td> <td></td> <td>1</td> <td>PZ</td> </tr> <tr> <td>RC1200A0</td> <td>ED=4 WIRE D.=0.5 COMPRESSIO N SPRING</td> <td>2</td> <td>PZ</td> </tr> </tbody> </table>	Code	Description	Qty	UOM	0B1126A0	DOOR LOWER FRAME SHAPE 860 MM	1	PZ	0B1126A1		1	PZ	RC1200A0	ED=4 WIRE D.=0.5 COMPRESSIO N SPRING	2	PZ
Code	Description	Qty	UOM																		
0B1126A0	DOOR LOWER FRAME SHAPE 860 MM	1	PZ																		
0B1126A1		1	PZ																		
RC1200A0	ED=4 WIRE D.=0.5 COMPRESSIO N SPRING	2	PZ																		









COMPONENT			SPARE PART																																														
Code	Description	Image	Code	Description	Components list																																												
VM2261A	6 SERIES DOOR LOWER RIGHT CAP		K0B1126AR	BAKERTOP MM RIGHT DOOR LOWER BEAM KIT	<table border="1"> <thead> <tr> <th>Code</th> <th>Description</th> <th>Qty</th> <th>UOM</th> </tr> </thead> <tbody> <tr> <td>VI1220A1</td> <td>4,2X12 TCB SELF-TAPPIN G SCREW</td> <td>1</td> <td>PZ</td> </tr> <tr> <td>VI1996A0</td> <td>M5X35 SCREW</td> <td>7</td> <td>PZ</td> </tr> <tr> <td>VM1794A0</td> <td>250X4.8 PA66 BLACK CLAMP</td> <td>2</td> <td>PZ</td> </tr> <tr> <td>VM2103A0</td> <td>CLAMP LOCK</td> <td>2</td> <td>PZ</td> </tr> <tr> <td>VM2259A1</td> <td>6 SERIES DOOR LOWER LEFT CAP</td> <td>1</td> <td>PZ</td> </tr> <tr> <td>VM2261A1</td> <td>6 SERIES DOOR LOWER RIGHT CAP</td> <td>1</td> <td>PZ</td> </tr> <tr> <td>VM2267A0</td> <td>INTERNAL GLASS LOCKING SYSTEM SLIDER</td> <td>1</td> <td>PZ</td> </tr> <tr> <td>VM2269A0</td> <td>INTERNAL GLASS LOCKING SYSTEM CAP</td> <td>1</td> <td>PZ</td> </tr> <tr> <td>VM2274A0</td> <td>GROOVED BUSHING</td> <td>1</td> <td>PZ</td> </tr> <tr> <td>VM2305A0</td> <td>6 SERIES DOOR CAP FIXING PAWL</td> <td>7</td> <td>PZ</td> </tr> </tbody> </table>	Code	Description	Qty	UOM	VI1220A1	4,2X12 TCB SELF-TAPPIN G SCREW	1	PZ	VI1996A0	M5X35 SCREW	7	PZ	VM1794A0	250X4.8 PA66 BLACK CLAMP	2	PZ	VM2103A0	CLAMP LOCK	2	PZ	VM2259A1	6 SERIES DOOR LOWER LEFT CAP	1	PZ	VM2261A1	6 SERIES DOOR LOWER RIGHT CAP	1	PZ	VM2267A0	INTERNAL GLASS LOCKING SYSTEM SLIDER	1	PZ	VM2269A0	INTERNAL GLASS LOCKING SYSTEM CAP	1	PZ	VM2274A0	GROOVED BUSHING	1	PZ	VM2305A0	6 SERIES DOOR CAP FIXING PAWL	7	PZ
			Code	Description	Qty	UOM																																											
VI1220A1	4,2X12 TCB SELF-TAPPIN G SCREW	1	PZ																																														
VI1996A0	M5X35 SCREW	7	PZ																																														
VM1794A0	250X4.8 PA66 BLACK CLAMP	2	PZ																																														
VM2103A0	CLAMP LOCK	2	PZ																																														
VM2259A1	6 SERIES DOOR LOWER LEFT CAP	1	PZ																																														
VM2261A1	6 SERIES DOOR LOWER RIGHT CAP	1	PZ																																														
VM2267A0	INTERNAL GLASS LOCKING SYSTEM SLIDER	1	PZ																																														
VM2269A0	INTERNAL GLASS LOCKING SYSTEM CAP	1	PZ																																														
VM2274A0	GROOVED BUSHING	1	PZ																																														
VM2305A0	6 SERIES DOOR CAP FIXING PAWL	7	PZ																																														
K0B1126AL	EU AND 2/1 MM LEFT DOOR LOWER BEAM KIT	<table border="1"> <thead> <tr> <th>Code</th> <th>Description</th> <th>Qty</th> <th>UOM</th> </tr> </thead> <tbody> <tr> <td>OB1126A0</td> <td>DOOR LOWER FRAME SHAPE 860 MM</td> <td>1</td> <td>PZ</td> </tr> <tr> <td>OB1126A1</td> <td></td> <td>1</td> <td>PZ</td> </tr> <tr> <td>RC1200A0</td> <td>ED=4 WIRE D.=0.5 COMPRESSIO N SPRING</td> <td>2</td> <td>PZ</td> </tr> <tr> <td>VI1220A1</td> <td>4,2X12 TCB SELF-TAPPIN G SCREW</td> <td>1</td> <td>PZ</td> </tr> <tr> <td>VI1996A0</td> <td>M5X35 SCREW</td> <td>7</td> <td>PZ</td> </tr> <tr> <td>VM1794A0</td> <td>250X4.8 PA66 BLACK CLAMP</td> <td>2</td> <td>PZ</td> </tr> <tr> <td>VM2103A0</td> <td>CLAMP LOCK</td> <td>2</td> <td>PZ</td> </tr> <tr> <td>VM2267A0</td> <td>INTERNAL GLASS LOCKING SYSTEM SLIDER</td> <td>1</td> <td>PZ</td> </tr> <tr> <td>VM2269A0</td> <td>INTERNAL GLASS LOCKING SYSTEM CAP</td> <td>1</td> <td>PZ</td> </tr> <tr> <td>VM2274A0</td> <td>GROOVED BUSHING</td> <td>1</td> <td>PZ</td> </tr> </tbody> </table>	Code	Description	Qty	UOM	OB1126A0	DOOR LOWER FRAME SHAPE 860 MM	1	PZ	OB1126A1		1	PZ	RC1200A0	ED=4 WIRE D.=0.5 COMPRESSIO N SPRING	2	PZ	VI1220A1	4,2X12 TCB SELF-TAPPIN G SCREW	1	PZ	VI1996A0	M5X35 SCREW	7	PZ	VM1794A0	250X4.8 PA66 BLACK CLAMP	2	PZ	VM2103A0	CLAMP LOCK	2	PZ	VM2267A0	INTERNAL GLASS LOCKING SYSTEM SLIDER	1	PZ	VM2269A0	INTERNAL GLASS LOCKING SYSTEM CAP	1	PZ	VM2274A0	GROOVED BUSHING	1	PZ			
Code	Description	Qty	UOM																																														
OB1126A0	DOOR LOWER FRAME SHAPE 860 MM	1	PZ																																														
OB1126A1		1	PZ																																														
RC1200A0	ED=4 WIRE D.=0.5 COMPRESSIO N SPRING	2	PZ																																														
VI1220A1	4,2X12 TCB SELF-TAPPIN G SCREW	1	PZ																																														
VI1996A0	M5X35 SCREW	7	PZ																																														
VM1794A0	250X4.8 PA66 BLACK CLAMP	2	PZ																																														
VM2103A0	CLAMP LOCK	2	PZ																																														
VM2267A0	INTERNAL GLASS LOCKING SYSTEM SLIDER	1	PZ																																														
VM2269A0	INTERNAL GLASS LOCKING SYSTEM CAP	1	PZ																																														
VM2274A0	GROOVED BUSHING	1	PZ																																														



COMPONENT			SPARE PART																																																							
Code	Description	Image	Code	Description	Components list																																																					
VM2261A	6 SERIES DOOR LOWER RIGHT CAP		K0B1126AL	EU AND 2/1 MM LEFT DOOR LOWER BEAM KIT	<table border="1"> <thead> <tr> <th>Code</th> <th>Description</th> <th>Qty</th> <th>UOM</th> </tr> </thead> <tbody> <tr> <td>VM2305A0</td> <td>6 SERIES DOOR CAP FIXING PAWL</td> <td>7</td> <td>PZ</td> </tr> <tr> <td>VM2384A0</td> <td>LEFT MM DOOR LOWER RIGHT CAP</td> <td>1</td> <td>PZ</td> </tr> <tr> <td>VM2384A0</td> <td>LEFT MM DOOR LOWER RIGHT CAP</td> <td>1</td> <td>PZ</td> </tr> <tr> <td>VM2386A1</td> <td>LEFT MM DOOR LOWER LEFT CAP</td> <td>1</td> <td>PZ</td> </tr> <tr> <td>VM2386A1</td> <td>LEFT MM DOOR LOWER LEFT CAP</td> <td>1</td> <td>PZ</td> </tr> </tbody> </table>	Code	Description	Qty	UOM	VM2305A0	6 SERIES DOOR CAP FIXING PAWL	7	PZ	VM2384A0	LEFT MM DOOR LOWER RIGHT CAP	1	PZ	VM2384A0	LEFT MM DOOR LOWER RIGHT CAP	1	PZ	VM2386A1	LEFT MM DOOR LOWER LEFT CAP	1	PZ	VM2386A1	LEFT MM DOOR LOWER LEFT CAP	1	PZ																													
			Code	Description	Qty	UOM																																																				
VM2305A0	6 SERIES DOOR CAP FIXING PAWL	7	PZ																																																							
VM2384A0	LEFT MM DOOR LOWER RIGHT CAP	1	PZ																																																							
VM2384A0	LEFT MM DOOR LOWER RIGHT CAP	1	PZ																																																							
VM2386A1	LEFT MM DOOR LOWER LEFT CAP	1	PZ																																																							
VM2386A1	LEFT MM DOOR LOWER LEFT CAP	1	PZ																																																							
K0B1122AR	CHEFTOP MM RIGHT DOOR LOWER BEAM KIT	<table border="1"> <thead> <tr> <th>Code</th> <th>Description</th> <th>Qty</th> <th>UOM</th> </tr> </thead> <tbody> <tr> <td>0B1122A0</td> <td>6 SERIES DOOR LOWER FRAME SHAPE</td> <td>1</td> <td>PZ</td> </tr> <tr> <td>0B1122A1</td> <td></td> <td>1</td> <td>PZ</td> </tr> <tr> <td>RC1200A0</td> <td>ED=4 WIRE D.=0.5 COMPRESSIO N SPRING</td> <td>2</td> <td>PZ</td> </tr> <tr> <td>VI1220A1</td> <td>4,2X12 TCB SELF-TAPPIN G SCREW</td> <td>1</td> <td>PZ</td> </tr> <tr> <td>VI1996A0</td> <td>M5X35 SCREW</td> <td>7</td> <td>PZ</td> </tr> <tr> <td>VM1794A0</td> <td>250X4.8 PA66 BLACK CLAMP</td> <td>2</td> <td>PZ</td> </tr> <tr> <td>VM2103A0</td> <td>CLAMP LOCK</td> <td>2</td> <td>PZ</td> </tr> <tr> <td>VM2259A1</td> <td>6 SERIES DOOR LOWER LEFT CAP</td> <td>1</td> <td>PZ</td> </tr> <tr> <td>VM2261A1</td> <td>6 SERIES DOOR LOWER RIGHT CAP</td> <td>1</td> <td>PZ</td> </tr> <tr> <td>VM2267A0</td> <td>INTERNAL GLASS LOCKING SYSTEM SLIDER</td> <td>1</td> <td>PZ</td> </tr> <tr> <td>VM2269A0</td> <td>INTERNAL GLASS LOCKING SYSTEM CAP</td> <td>1</td> <td>PZ</td> </tr> <tr> <td>VM2274A0</td> <td>GROOVED BUSHING</td> <td>1</td> <td>PZ</td> </tr> <tr> <td>VM2305A0</td> <td>6 SERIES DOOR CAP FIXING PAWL</td> <td>7</td> <td>PZ</td> </tr> </tbody> </table>	Code	Description	Qty	UOM	0B1122A0	6 SERIES DOOR LOWER FRAME SHAPE	1	PZ	0B1122A1		1	PZ	RC1200A0	ED=4 WIRE D.=0.5 COMPRESSIO N SPRING	2	PZ	VI1220A1	4,2X12 TCB SELF-TAPPIN G SCREW	1	PZ	VI1996A0	M5X35 SCREW	7	PZ	VM1794A0	250X4.8 PA66 BLACK CLAMP	2	PZ	VM2103A0	CLAMP LOCK	2	PZ	VM2259A1	6 SERIES DOOR LOWER LEFT CAP	1	PZ	VM2261A1	6 SERIES DOOR LOWER RIGHT CAP	1	PZ	VM2267A0	INTERNAL GLASS LOCKING SYSTEM SLIDER	1	PZ	VM2269A0	INTERNAL GLASS LOCKING SYSTEM CAP	1	PZ	VM2274A0	GROOVED BUSHING	1	PZ	VM2305A0	6 SERIES DOOR CAP FIXING PAWL	7	PZ
Code	Description	Qty	UOM																																																							
0B1122A0	6 SERIES DOOR LOWER FRAME SHAPE	1	PZ																																																							
0B1122A1		1	PZ																																																							
RC1200A0	ED=4 WIRE D.=0.5 COMPRESSIO N SPRING	2	PZ																																																							
VI1220A1	4,2X12 TCB SELF-TAPPIN G SCREW	1	PZ																																																							
VI1996A0	M5X35 SCREW	7	PZ																																																							
VM1794A0	250X4.8 PA66 BLACK CLAMP	2	PZ																																																							
VM2103A0	CLAMP LOCK	2	PZ																																																							
VM2259A1	6 SERIES DOOR LOWER LEFT CAP	1	PZ																																																							
VM2261A1	6 SERIES DOOR LOWER RIGHT CAP	1	PZ																																																							
VM2267A0	INTERNAL GLASS LOCKING SYSTEM SLIDER	1	PZ																																																							
VM2269A0	INTERNAL GLASS LOCKING SYSTEM CAP	1	PZ																																																							
VM2274A0	GROOVED BUSHING	1	PZ																																																							
VM2305A0	6 SERIES DOOR CAP FIXING PAWL	7	PZ																																																							





COMPONENT			SPARE PART																																																																		
Code	Description	Image	Code	Description	Components list																																																																
VM2261A	6 SERIES DOOR LOWER RIGHT CAP		K0B1122AL	CHEFTOP MM LEFT DOOR LOWER DOOR LOWER BEAM KIT	<table border="1"> <thead> <tr> <th>Code</th> <th>Description</th> <th>Qty</th> <th>UOM</th> </tr> </thead> <tbody> <tr> <td>0B1122A0</td> <td>6 SERIES DOOR LOWER FRAME SHAPE</td> <td>1</td> <td>PZ</td> </tr> <tr> <td>0B1122A1</td> <td></td> <td>1</td> <td>PZ</td> </tr> <tr> <td>RC1200A0</td> <td>ED=4 WIRE D.=0.5 COMPRESSIO N SPRING</td> <td>2</td> <td>PZ</td> </tr> <tr> <td>VI1220A1</td> <td>4,2X12 TCB SELF-TAPPIN G SCREW</td> <td>1</td> <td>PZ</td> </tr> <tr> <td>VI1996A0</td> <td>M5X35 SCREW</td> <td>7</td> <td>PZ</td> </tr> <tr> <td>VM1794A0</td> <td>250X4.8 PA66 BLACK CLAMP</td> <td>2</td> <td>PZ</td> </tr> <tr> <td>VM2103A0</td> <td>CLAMP LOCK</td> <td>2</td> <td>PZ</td> </tr> <tr> <td>VM2267A0</td> <td>INTERNAL GLASS LOCKING SYSTEM SLIDER</td> <td>1</td> <td>PZ</td> </tr> <tr> <td>VM2269A0</td> <td>INTERNAL GLASS LOCKING SYSTEM CAP</td> <td>1</td> <td>PZ</td> </tr> <tr> <td>VM2274A0</td> <td>GROOVED BUSHING</td> <td>1</td> <td>PZ</td> </tr> <tr> <td>VM2305A0</td> <td>6 SERIES DOOR CAP FIXING PAWL</td> <td>7</td> <td>PZ</td> </tr> <tr> <td>VM2384A0</td> <td>LEFT MM DOOR LOWER RIGHT CAP</td> <td>1</td> <td>PZ</td> </tr> <tr> <td>VM2384A0</td> <td>LEFT MM DOOR LOWER RIGHT CAP</td> <td>1</td> <td>PZ</td> </tr> <tr> <td>VM2386A1</td> <td>LEFT MM DOOR LOWER LEFT CAP</td> <td>1</td> <td>PZ</td> </tr> <tr> <td>VM2386A1</td> <td>LEFT MM DOOR LOWER LEFT CAP</td> <td>1</td> <td>PZ</td> </tr> </tbody> </table>	Code	Description	Qty	UOM	0B1122A0	6 SERIES DOOR LOWER FRAME SHAPE	1	PZ	0B1122A1		1	PZ	RC1200A0	ED=4 WIRE D.=0.5 COMPRESSIO N SPRING	2	PZ	VI1220A1	4,2X12 TCB SELF-TAPPIN G SCREW	1	PZ	VI1996A0	M5X35 SCREW	7	PZ	VM1794A0	250X4.8 PA66 BLACK CLAMP	2	PZ	VM2103A0	CLAMP LOCK	2	PZ	VM2267A0	INTERNAL GLASS LOCKING SYSTEM SLIDER	1	PZ	VM2269A0	INTERNAL GLASS LOCKING SYSTEM CAP	1	PZ	VM2274A0	GROOVED BUSHING	1	PZ	VM2305A0	6 SERIES DOOR CAP FIXING PAWL	7	PZ	VM2384A0	LEFT MM DOOR LOWER RIGHT CAP	1	PZ	VM2384A0	LEFT MM DOOR LOWER RIGHT CAP	1	PZ	VM2386A1	LEFT MM DOOR LOWER LEFT CAP	1	PZ	VM2386A1	LEFT MM DOOR LOWER LEFT CAP	1	PZ
					Code	Description	Qty	UOM																																																													
0B1122A0	6 SERIES DOOR LOWER FRAME SHAPE	1	PZ																																																																		
0B1122A1		1	PZ																																																																		
RC1200A0	ED=4 WIRE D.=0.5 COMPRESSIO N SPRING	2	PZ																																																																		
VI1220A1	4,2X12 TCB SELF-TAPPIN G SCREW	1	PZ																																																																		
VI1996A0	M5X35 SCREW	7	PZ																																																																		
VM1794A0	250X4.8 PA66 BLACK CLAMP	2	PZ																																																																		
VM2103A0	CLAMP LOCK	2	PZ																																																																		
VM2267A0	INTERNAL GLASS LOCKING SYSTEM SLIDER	1	PZ																																																																		
VM2269A0	INTERNAL GLASS LOCKING SYSTEM CAP	1	PZ																																																																		
VM2274A0	GROOVED BUSHING	1	PZ																																																																		
VM2305A0	6 SERIES DOOR CAP FIXING PAWL	7	PZ																																																																		
VM2384A0	LEFT MM DOOR LOWER RIGHT CAP	1	PZ																																																																		
VM2384A0	LEFT MM DOOR LOWER RIGHT CAP	1	PZ																																																																		
VM2386A1	LEFT MM DOOR LOWER LEFT CAP	1	PZ																																																																		
VM2386A1	LEFT MM DOOR LOWER LEFT CAP	1	PZ																																																																		
PE2044A	MM PLUS VERSION CONTROL BOARD		KPE2044A	MIND.MAPS PLUS CONTROL BOARD KIT	<table border="1"> <thead> <tr> <th>Code</th> <th>Description</th> <th>Qty</th> <th>UOM</th> </tr> </thead> <tbody> <tr> <td>PE2044A3</td> <td>MM PLUS VERSION CONTROL BOARD</td> <td>1</td> <td>PZ</td> </tr> <tr> <td>PE2044A4</td> <td>MM PLUS VERSION CONTROL BOARD</td> <td>1</td> <td>PZ</td> </tr> <tr> <td>VI1074A0</td> <td></td> <td>2</td> <td>PZ</td> </tr> <tr> <td>VI2000A0</td> <td>SCREW M4X22 TCB+ INOX</td> <td>4</td> <td>PZ</td> </tr> <tr> <td>VM2147A0</td> <td>ESD SPONGE PINK SMOOTH 410X343X15 M</td> <td>1</td> <td>PZ</td> </tr> </tbody> </table>	Code	Description	Qty	UOM	PE2044A3	MM PLUS VERSION CONTROL BOARD	1	PZ	PE2044A4	MM PLUS VERSION CONTROL BOARD	1	PZ	VI1074A0		2	PZ	VI2000A0	SCREW M4X22 TCB+ INOX	4	PZ	VM2147A0	ESD SPONGE PINK SMOOTH 410X343X15 M	1	PZ																																								
Code	Description	Qty	UOM																																																																		
PE2044A3	MM PLUS VERSION CONTROL BOARD	1	PZ																																																																		
PE2044A4	MM PLUS VERSION CONTROL BOARD	1	PZ																																																																		
VI1074A0		2	PZ																																																																		
VI2000A0	SCREW M4X22 TCB+ INOX	4	PZ																																																																		
VM2147A0	ESD SPONGE PINK SMOOTH 410X343X15 M	1	PZ																																																																		

COMPONENT			SPARE PART																		
Code	Description	Image	Code	Description	Components list																
PE2046A	MM POWER SWITCH AND USB BOARD		KPE2046A	MIND.MAPS USB-RESET SUPPORT KIT	<table border="1"> <thead> <tr> <th>Code</th> <th>Description</th> <th>Qty</th> <th>UOM</th> </tr> </thead> <tbody> <tr> <td>PE2046A2</td> <td>MM POWER SWITCH AND USB BOARD</td> <td>1</td> <td>PZ</td> </tr> <tr> <td>VI1220A1</td> <td>4,2X12 TCB SELF-TAPPING SCREW</td> <td>2</td> <td>PZ</td> </tr> <tr> <td>VM2147A0</td> <td>ESD SPONGE PINK SMOOTH 410X343X15 M</td> <td>0.250</td> <td>PZ</td> </tr> </tbody> </table>	Code	Description	Qty	UOM	PE2046A2	MM POWER SWITCH AND USB BOARD	1	PZ	VI1220A1	4,2X12 TCB SELF-TAPPING SCREW	2	PZ	VM2147A0	ESD SPONGE PINK SMOOTH 410X343X15 M	0.250	PZ
Code	Description	Qty	UOM																		
PE2046A2	MM POWER SWITCH AND USB BOARD	1	PZ																		
VI1220A1	4,2X12 TCB SELF-TAPPING SCREW	2	PZ																		
VM2147A0	ESD SPONGE PINK SMOOTH 410X343X15 M	0.250	PZ																		
VM2371A	DOUBLE GLASS DOOR PUSHING BRACKET		KVM2505A	CAP FOR INTERNAL DOUBLE GLASS 3PCS KIT	<table border="1"> <thead> <tr> <th>Code</th> <th>Description</th> <th>Qty</th> <th>UOM</th> </tr> </thead> <tbody> <tr> <td>VI1220A1</td> <td>4,2X12 TCB SELF-TAPPING SCREW</td> <td>3</td> <td>PZ</td> </tr> <tr> <td>VM1631A0</td> <td></td> <td>3</td> <td>PZ</td> </tr> <tr> <td>VM2505A0</td> <td>MM PLUS INTERNAL GLASS SUPPORT</td> <td>3</td> <td>PZ</td> </tr> </tbody> </table>	Code	Description	Qty	UOM	VI1220A1	4,2X12 TCB SELF-TAPPING SCREW	3	PZ	VM1631A0		3	PZ	VM2505A0	MM PLUS INTERNAL GLASS SUPPORT	3	PZ
Code	Description	Qty	UOM																		
VI1220A1	4,2X12 TCB SELF-TAPPING SCREW	3	PZ																		
VM1631A0		3	PZ																		
VM2505A0	MM PLUS INTERNAL GLASS SUPPORT	3	PZ																		
VM2284A	750 SERIES DRIP PROFILE		KVM2284A	750 SERIES DRIP PROFILE KIT	<table border="1"> <thead> <tr> <th>Code</th> <th>Description</th> <th>Qty</th> <th>UOM</th> </tr> </thead> <tbody> <tr> <td>VM2284A0</td> <td>750 SERIES DRIP PROFILE</td> <td>1</td> <td>PZ</td> </tr> </tbody> </table>	Code	Description	Qty	UOM	VM2284A0	750 SERIES DRIP PROFILE	1	PZ								
Code	Description	Qty	UOM																		
VM2284A0	750 SERIES DRIP PROFILE	1	PZ																		
VM2314A	6 S. DRIP PROFILE CAP		KVM2314A	MIND.MAPS DRIP TRAY CAP	<table border="1"> <thead> <tr> <th>Code</th> <th>Description</th> <th>Qty</th> <th>UOM</th> </tr> </thead> <tbody> <tr> <td>VM2314A0</td> <td>6 S. DRIP PROFILE CAP</td> <td>1</td> <td>PZ</td> </tr> </tbody> </table>	Code	Description	Qty	UOM	VM2314A0	6 S. DRIP PROFILE CAP	1	PZ								
Code	Description	Qty	UOM																		
VM2314A0	6 S. DRIP PROFILE CAP	1	PZ																		
LP1019A	6 SERIES L200 LED LIGHT BAR - E415		KLP1019A	L200 E415 LED LIGHT BAR KIT	<table border="1"> <thead> <tr> <th>Code</th> <th>Description</th> <th>Qty</th> <th>UOM</th> </tr> </thead> <tbody> <tr> <td>IP1385A1</td> <td>CORNER POLYSTYRENE PACKING 110X80X2000</td> <td>0.900</td> <td>M</td> </tr> <tr> <td>LP1019A0</td> <td>6 SERIES L200 LED LIGHT BAR - E415</td> <td>1</td> <td>PZ</td> </tr> <tr> <td>VM1059A1</td> <td>HEAT SHRINK FILM H800</td> <td>0.900</td> <td>M</td> </tr> </tbody> </table>	Code	Description	Qty	UOM	IP1385A1	CORNER POLYSTYRENE PACKING 110X80X2000	0.900	M	LP1019A0	6 SERIES L200 LED LIGHT BAR - E415	1	PZ	VM1059A1	HEAT SHRINK FILM H800	0.900	M
Code	Description	Qty	UOM																		
IP1385A1	CORNER POLYSTYRENE PACKING 110X80X2000	0.900	M																		
LP1019A0	6 SERIES L200 LED LIGHT BAR - E415	1	PZ																		
VM1059A1	HEAT SHRINK FILM H800	0.900	M																		



COMPONENT			SPARE PART																		
Code	Description	Image	Code	Description	Components list																
LP1025A	L=415 LED LIGHT BAR COVER		KLP1025A	L415 MM NO LED LIGHT HOLDER KIT	<table border="1"> <thead> <tr> <th>Code</th> <th>Description</th> <th>Qty</th> <th>UOM</th> </tr> </thead> <tbody> <tr> <td>IP1385A1</td> <td>CORNER POLYSTYRENE PACKING 110X80X2000</td> <td>0.900</td> <td>M</td> </tr> <tr> <td>LP1025A0</td> <td>L=415 LED LIGHT BAR COVER</td> <td>1</td> <td>PZ</td> </tr> <tr> <td>VM1059A1</td> <td>HEAT SHRINK FILM H800</td> <td>0.900</td> <td>M</td> </tr> </tbody> </table>	Code	Description	Qty	UOM	IP1385A1	CORNER POLYSTYRENE PACKING 110X80X2000	0.900	M	LP1025A0	L=415 LED LIGHT BAR COVER	1	PZ	VM1059A1	HEAT SHRINK FILM H800	0.900	M
Code	Description	Qty	UOM																		
IP1385A1	CORNER POLYSTYRENE PACKING 110X80X2000	0.900	M																		
LP1025A0	L=415 LED LIGHT BAR COVER	1	PZ																		
VM1059A1	HEAT SHRINK FILM H800	0.900	M																		
VN1177A	CONTROL BOARD COOLING FAN		KVN1177A	CONTROL BOARD COOLING FAN KIT	<table border="1"> <thead> <tr> <th>Code</th> <th>Description</th> <th>Qty</th> <th>UOM</th> </tr> </thead> <tbody> <tr> <td>VN1177A0</td> <td>CONTROL BOARD COOLING FAN</td> <td>1</td> <td>PZ</td> </tr> <tr> <td>VN1177A0</td> <td>CONTROL BOARD COOLING FAN</td> <td>1</td> <td>PZ</td> </tr> </tbody> </table>	Code	Description	Qty	UOM	VN1177A0	CONTROL BOARD COOLING FAN	1	PZ	VN1177A0	CONTROL BOARD COOLING FAN	1	PZ				
Code	Description	Qty	UOM																		
VN1177A0	CONTROL BOARD COOLING FAN	1	PZ																		
VN1177A0	CONTROL BOARD COOLING FAN	1	PZ																		
VM2316A	CONTROL BOARD COOLING FAN HOLDER		KVM2518A	PANEL COOLING FAN SUPPORT KIT	<table border="1"> <thead> <tr> <th>Code</th> <th>Description</th> <th>Qty</th> <th>UOM</th> </tr> </thead> <tbody> <tr> <td>VM2518A0</td> <td>BOARD COOLING FAN SUPPORT</td> <td>1</td> <td>PZ</td> </tr> <tr> <td>VM2518A0</td> <td>BOARD COOLING FAN SUPPORT</td> <td>1</td> <td>PZ</td> </tr> </tbody> </table>	Code	Description	Qty	UOM	VM2518A0	BOARD COOLING FAN SUPPORT	1	PZ	VM2518A0	BOARD COOLING FAN SUPPORT	1	PZ				
Code	Description	Qty	UOM																		
VM2518A0	BOARD COOLING FAN SUPPORT	1	PZ																		
VM2518A0	BOARD COOLING FAN SUPPORT	1	PZ																		
			KVM2316A	PANEL COOLING FAN SUPPORT KIT	<table border="1"> <thead> <tr> <th>Code</th> <th>Description</th> <th>Qty</th> <th>UOM</th> </tr> </thead> <tbody> <tr> <td>VM2316A0</td> <td>CONTROL BOARD COOLING FAN HOLDER</td> <td>1</td> <td>PZ</td> </tr> </tbody> </table>	Code	Description	Qty	UOM	VM2316A0	CONTROL BOARD COOLING FAN HOLDER	1	PZ								
Code	Description	Qty	UOM																		
VM2316A0	CONTROL BOARD COOLING FAN HOLDER	1	PZ																		
CE1285A	EMI ROUND FERRITE MOD.2643801502		CE1285A0	EMI ROUND FERRITE MOD.2643801502																	
CE1275A	CONNECTION CABLE POWER - CONTROL		KCE1275A	CONNECTING CABLE KIT	<table border="1"> <thead> <tr> <th>Code</th> <th>Description</th> <th>Qty</th> <th>UOM</th> </tr> </thead> <tbody> <tr> <td>CE1285A0</td> <td>EMI ROUND FERRITE MOD.2643801502</td> <td>1</td> <td>PZ</td> </tr> <tr> <td>CE1290A0</td> <td>EXTRACTABLE FEMALE TERMINAL CPF 5/4</td> <td>1</td> <td>PZ</td> </tr> </tbody> </table>	Code	Description	Qty	UOM	CE1285A0	EMI ROUND FERRITE MOD.2643801502	1	PZ	CE1290A0	EXTRACTABLE FEMALE TERMINAL CPF 5/4	1	PZ				
Code	Description	Qty	UOM																		
CE1285A0	EMI ROUND FERRITE MOD.2643801502	1	PZ																		
CE1290A0	EXTRACTABLE FEMALE TERMINAL CPF 5/4	1	PZ																		

COMPONENT			SPARE PART																						
Code	Description	Image	Code	Description	Components list																				
CE1275A	CONNECTION CABLE POWER - CONTROL		KCE1275A	CONNECTING CABLE KIT	<table border="1"> <thead> <tr> <th>Code</th> <th>Description</th> <th>Qty</th> <th>UOM</th> </tr> </thead> <tbody> <tr> <td>CE1455A0</td> <td>TIP END FITTING</td> <td>4</td> <td>PZ</td> </tr> <tr> <td>CE1725A0</td> <td>ROBOTICS SILICON PIPE 4X0,5 MMO</td> <td>3</td> <td>M</td> </tr> <tr> <td>CE1735A0</td> <td>MINIFIT FEMALE END FITTING</td> <td>4</td> <td>PZ</td> </tr> <tr> <td>CE1755A0</td> <td>4 WAYS MALE MINIFIT CONNECTOR</td> <td>1</td> <td>PZ</td> </tr> </tbody> </table>	Code	Description	Qty	UOM	CE1455A0	TIP END FITTING	4	PZ	CE1725A0	ROBOTICS SILICON PIPE 4X0,5 MMO	3	M	CE1735A0	MINIFIT FEMALE END FITTING	4	PZ	CE1755A0	4 WAYS MALE MINIFIT CONNECTOR	1	PZ
Code	Description	Qty	UOM																						
CE1455A0	TIP END FITTING	4	PZ																						
CE1725A0	ROBOTICS SILICON PIPE 4X0,5 MMO	3	M																						
CE1735A0	MINIFIT FEMALE END FITTING	4	PZ																						
CE1755A0	4 WAYS MALE MINIFIT CONNECTOR	1	PZ																						
0B1106A	XEVC-0511-E DOOR EXTERNAL LEFT COLUMN		0B1106A0	XEVC-0511-E DOOR EXTERNAL LEFT COLUMN																					
0B1108A	XEVC-0511-E DOOR EXTERNAL RIGHT COLUMN		0B1108A0	XEVC-0511-E DOOR EXTERNAL RIGHT COLUMN																					
0B1107A	XEVC-0511-E DOOR INTERNAL LEFT COLUMN		OUTOFPRODUCTIO																						
0B1109A	XEVC-0511-E DOOR INTERNAL RIGHT COLUMN		OUTOFPRODUCTIO																						

COMPONENT			SPARE PART																																																										
Code	Description	Image	Code	Description	Components list																																																								
CE1053B	MM MICROFIT LED BAR POWER SUPPLY CABLE		OUTOFPRODUCTIO																																																										
VT1284A	INT. GLASS SER. 0511 639X454X4 2V		KVT1284A	0511 INNER DOUBLE GLASS KIT	<table border="1"> <thead> <tr> <th>Code</th> <th>Description</th> <th>Qty</th> <th>UOM</th> </tr> </thead> <tbody> <tr> <td>OB1180A0</td> <td>GN1/1 INT DOUBLE GLASS INF-SUP BEAM</td> <td>2</td> <td>PZ</td> </tr> <tr> <td>OB1181A0</td> <td>0511 DOUBLE GLASS RIGHT-LEFT PROFILE</td> <td>2</td> <td>PZ</td> </tr> <tr> <td>OB1210A0</td> <td>GN1/1 DOUBLE GLASS EXT SUP-INF PROFILE</td> <td>2</td> <td>PZ</td> </tr> <tr> <td>OB1212A1</td> <td></td> <td>2</td> <td>PZ</td> </tr> <tr> <td>OB1212A3</td> <td></td> <td>2</td> <td>PZ</td> </tr> <tr> <td>CR1105A0</td> <td>HINGES INTERNAL GLASS DOUBL</td> <td>1</td> <td>PZ</td> </tr> <tr> <td>CR1106A0</td> <td>HINGES INTERNAL GLASS DOUBL</td> <td>1</td> <td>PZ</td> </tr> <tr> <td>IP1508A1</td> <td>POLYSTYREN E U SHAPED PROFILE 2000X60X60</td> <td>2</td> <td>M</td> </tr> <tr> <td>V11220A1</td> <td>4,2X12 TCB SELF-TAPPIN G SCREW</td> <td>4</td> <td>PZ</td> </tr> <tr> <td>V11225A0</td> <td>STAINLESS STEEL STRUCTURE RIVET 4X10.1</td> <td>20</td> <td>PZ</td> </tr> <tr> <td>VM1059A1</td> <td>HEAT SHRINK FILM H800</td> <td>1.500</td> <td>M</td> </tr> <tr> <td>VT1284A1</td> <td>INT. GLASS SER. 0511 639X454X4 2V</td> <td>2</td> <td>PZ</td> </tr> <tr> <td>VT1284A1</td> <td>INT. GLASS SER. 0511 639X454X4 2V</td> <td>2</td> <td>PZ</td> </tr> </tbody> </table>	Code	Description	Qty	UOM	OB1180A0	GN1/1 INT DOUBLE GLASS INF-SUP BEAM	2	PZ	OB1181A0	0511 DOUBLE GLASS RIGHT-LEFT PROFILE	2	PZ	OB1210A0	GN1/1 DOUBLE GLASS EXT SUP-INF PROFILE	2	PZ	OB1212A1		2	PZ	OB1212A3		2	PZ	CR1105A0	HINGES INTERNAL GLASS DOUBL	1	PZ	CR1106A0	HINGES INTERNAL GLASS DOUBL	1	PZ	IP1508A1	POLYSTYREN E U SHAPED PROFILE 2000X60X60	2	M	V11220A1	4,2X12 TCB SELF-TAPPIN G SCREW	4	PZ	V11225A0	STAINLESS STEEL STRUCTURE RIVET 4X10.1	20	PZ	VM1059A1	HEAT SHRINK FILM H800	1.500	M	VT1284A1	INT. GLASS SER. 0511 639X454X4 2V	2	PZ	VT1284A1	INT. GLASS SER. 0511 639X454X4 2V	2	PZ
Code	Description	Qty	UOM																																																										
OB1180A0	GN1/1 INT DOUBLE GLASS INF-SUP BEAM	2	PZ																																																										
OB1181A0	0511 DOUBLE GLASS RIGHT-LEFT PROFILE	2	PZ																																																										
OB1210A0	GN1/1 DOUBLE GLASS EXT SUP-INF PROFILE	2	PZ																																																										
OB1212A1		2	PZ																																																										
OB1212A3		2	PZ																																																										
CR1105A0	HINGES INTERNAL GLASS DOUBL	1	PZ																																																										
CR1106A0	HINGES INTERNAL GLASS DOUBL	1	PZ																																																										
IP1508A1	POLYSTYREN E U SHAPED PROFILE 2000X60X60	2	M																																																										
V11220A1	4,2X12 TCB SELF-TAPPIN G SCREW	4	PZ																																																										
V11225A0	STAINLESS STEEL STRUCTURE RIVET 4X10.1	20	PZ																																																										
VM1059A1	HEAT SHRINK FILM H800	1.500	M																																																										
VT1284A1	INT. GLASS SER. 0511 639X454X4 2V	2	PZ																																																										
VT1284A1	INT. GLASS SER. 0511 639X454X4 2V	2	PZ																																																										

COMPONENT			SPARE PART																		
Code	Description	Image	Code	Description	Components list																
CR1105A	HINGES INTERNAL GLASS DOUBLE		KCR1105A	MIND.MAPS PLUS INTERNAL GLASS HINGES KIT	<table border="1"> <thead> <tr> <th>Code</th> <th>Description</th> <th>Qty</th> <th>UOM</th> </tr> </thead> <tbody> <tr> <td>CR1105A0</td> <td>HINGES INTERNAL GLASS DOUBL</td> <td>1</td> <td>PZ</td> </tr> <tr> <td>CR1106A0</td> <td>HINGES INTERNAL GLASS DOUBL</td> <td>1</td> <td>PZ</td> </tr> <tr> <td>VI1220A1</td> <td>4,2X12 TCB SELF-TAPPIN G SCREW</td> <td>4</td> <td>PZ</td> </tr> </tbody> </table>	Code	Description	Qty	UOM	CR1105A0	HINGES INTERNAL GLASS DOUBL	1	PZ	CR1106A0	HINGES INTERNAL GLASS DOUBL	1	PZ	VI1220A1	4,2X12 TCB SELF-TAPPIN G SCREW	4	PZ
Code	Description	Qty	UOM																		
CR1105A0	HINGES INTERNAL GLASS DOUBL	1	PZ																		
CR1106A0	HINGES INTERNAL GLASS DOUBL	1	PZ																		
VI1220A1	4,2X12 TCB SELF-TAPPIN G SCREW	4	PZ																		
CR1106A	HINGES INTERNAL GLASS DOUBLE		KCR1105A	MIND.MAPS PLUS INTERNAL GLASS HINGES KIT	<table border="1"> <thead> <tr> <th>Code</th> <th>Description</th> <th>Qty</th> <th>UOM</th> </tr> </thead> <tbody> <tr> <td>CR1105A0</td> <td>HINGES INTERNAL GLASS DOUBL</td> <td>1</td> <td>PZ</td> </tr> <tr> <td>CR1106A0</td> <td>HINGES INTERNAL GLASS DOUBL</td> <td>1</td> <td>PZ</td> </tr> <tr> <td>VI1220A1</td> <td>4,2X12 TCB SELF-TAPPIN G SCREW</td> <td>4</td> <td>PZ</td> </tr> </tbody> </table>	Code	Description	Qty	UOM	CR1105A0	HINGES INTERNAL GLASS DOUBL	1	PZ	CR1106A0	HINGES INTERNAL GLASS DOUBL	1	PZ	VI1220A1	4,2X12 TCB SELF-TAPPIN G SCREW	4	PZ
Code	Description	Qty	UOM																		
CR1105A0	HINGES INTERNAL GLASS DOUBL	1	PZ																		
CR1106A0	HINGES INTERNAL GLASS DOUBL	1	PZ																		
VI1220A1	4,2X12 TCB SELF-TAPPIN G SCREW	4	PZ																		
VI1034A	STAINLESS STEEL WASHER 8.4X16X1		VI1034A0	STAINLESS STEEL WASHER 8.4X16X1																	
CE1052A	CABLE CONNECTION CONTROL - USB MM 750MM		KCE1052A	CONTROL BOARD-USB 650 CONN. CABLE KIT	<table border="1"> <thead> <tr> <th>Code</th> <th>Description</th> <th>Qty</th> <th>UOM</th> </tr> </thead> <tbody> <tr> <td>CE1052A1</td> <td>CABLE CONNECTION CONTROL - USB MM 750M</td> <td>1</td> <td>PZ</td> </tr> </tbody> </table>	Code	Description	Qty	UOM	CE1052A1	CABLE CONNECTION CONTROL - USB MM 750M	1	PZ								
Code	Description	Qty	UOM																		
CE1052A1	CABLE CONNECTION CONTROL - USB MM 750M	1	PZ																		
0B1216A	MM DOUBLE GLASS DOOR UPPER BEAM 750		0B1216A0	MM DOUBLE GLASS DOOR UPPER BEAM 750																	



COMPONENT			SPARE PART																																																										
Code	Description	Image	Code	Description	Components list																																																								
OB1217A			OUTOFPRODUCTIO																																																										
OB1122A	6 SERIES DOOR LOWER FRAME SHAPE		K0B1122AR	CHEFTOP MM RIGHT DOOR LOWER BEAM KIT	<table border="1"> <thead> <tr> <th>Code</th> <th>Description</th> <th>Qty</th> <th>UOM</th> </tr> </thead> <tbody> <tr> <td>OB1122A0</td> <td>6 SERIES DOOR LOWER FRAME SHAPE</td> <td>1</td> <td>PZ</td> </tr> <tr> <td>OB1122A1</td> <td></td> <td>1</td> <td>PZ</td> </tr> <tr> <td>RC1200A0</td> <td>ED=4 WIRE D.=0.5 COMPRESSIO N SPRING</td> <td>2</td> <td>PZ</td> </tr> <tr> <td>VI1220A1</td> <td>4.2X12 TCB SELF-TAPPIN G SCREW</td> <td>1</td> <td>PZ</td> </tr> <tr> <td>VI1996A0</td> <td>M5X35 SCREW</td> <td>7</td> <td>PZ</td> </tr> <tr> <td>VM1794A0</td> <td>250X4.8 PA66 BLACK CLAMP</td> <td>2</td> <td>PZ</td> </tr> <tr> <td>VM2103A0</td> <td>CLAMP LOCK</td> <td>2</td> <td>PZ</td> </tr> <tr> <td>VM2259A1</td> <td>6 SERIES DOOR LOWER LEFT CAP</td> <td>1</td> <td>PZ</td> </tr> <tr> <td>VM2261A1</td> <td>6 SERIES DOOR LOWER RIGHT CAP</td> <td>1</td> <td>PZ</td> </tr> <tr> <td>VM2267A0</td> <td>INTERNAL GLASS LOCKING SYSTEM SLIDER</td> <td>1</td> <td>PZ</td> </tr> <tr> <td>VM2269A0</td> <td>INTERNAL GLASS LOCKING SYSTEM CAP</td> <td>1</td> <td>PZ</td> </tr> <tr> <td>VM2274A0</td> <td>GROOVED BUSHING</td> <td>1</td> <td>PZ</td> </tr> <tr> <td>VM2305A0</td> <td>6 SERIES DOOR CAP FIXING PAWL</td> <td>7</td> <td>PZ</td> </tr> </tbody> </table>	Code	Description	Qty	UOM	OB1122A0	6 SERIES DOOR LOWER FRAME SHAPE	1	PZ	OB1122A1		1	PZ	RC1200A0	ED=4 WIRE D.=0.5 COMPRESSIO N SPRING	2	PZ	VI1220A1	4.2X12 TCB SELF-TAPPIN G SCREW	1	PZ	VI1996A0	M5X35 SCREW	7	PZ	VM1794A0	250X4.8 PA66 BLACK CLAMP	2	PZ	VM2103A0	CLAMP LOCK	2	PZ	VM2259A1	6 SERIES DOOR LOWER LEFT CAP	1	PZ	VM2261A1	6 SERIES DOOR LOWER RIGHT CAP	1	PZ	VM2267A0	INTERNAL GLASS LOCKING SYSTEM SLIDER	1	PZ	VM2269A0	INTERNAL GLASS LOCKING SYSTEM CAP	1	PZ	VM2274A0	GROOVED BUSHING	1	PZ	VM2305A0	6 SERIES DOOR CAP FIXING PAWL	7	PZ
Code	Description	Qty	UOM																																																										
OB1122A0	6 SERIES DOOR LOWER FRAME SHAPE	1	PZ																																																										
OB1122A1		1	PZ																																																										
RC1200A0	ED=4 WIRE D.=0.5 COMPRESSIO N SPRING	2	PZ																																																										
VI1220A1	4.2X12 TCB SELF-TAPPIN G SCREW	1	PZ																																																										
VI1996A0	M5X35 SCREW	7	PZ																																																										
VM1794A0	250X4.8 PA66 BLACK CLAMP	2	PZ																																																										
VM2103A0	CLAMP LOCK	2	PZ																																																										
VM2259A1	6 SERIES DOOR LOWER LEFT CAP	1	PZ																																																										
VM2261A1	6 SERIES DOOR LOWER RIGHT CAP	1	PZ																																																										
VM2267A0	INTERNAL GLASS LOCKING SYSTEM SLIDER	1	PZ																																																										
VM2269A0	INTERNAL GLASS LOCKING SYSTEM CAP	1	PZ																																																										
VM2274A0	GROOVED BUSHING	1	PZ																																																										
VM2305A0	6 SERIES DOOR CAP FIXING PAWL	7	PZ																																																										
			K0B1122AL	CHEFTOP MM LEFT DOOR LOWER BEAM KIT	<table border="1"> <thead> <tr> <th>Code</th> <th>Description</th> <th>Qty</th> <th>UOM</th> </tr> </thead> <tbody> <tr> <td>OB1122A0</td> <td>6 SERIES DOOR LOWER FRAME SHAPE</td> <td>1</td> <td>PZ</td> </tr> <tr> <td>OB1122A1</td> <td></td> <td>1</td> <td>PZ</td> </tr> <tr> <td>RC1200A0</td> <td>ED=4 WIRE D.=0.5 COMPRESSIO N SPRING</td> <td>2</td> <td>PZ</td> </tr> </tbody> </table>	Code	Description	Qty	UOM	OB1122A0	6 SERIES DOOR LOWER FRAME SHAPE	1	PZ	OB1122A1		1	PZ	RC1200A0	ED=4 WIRE D.=0.5 COMPRESSIO N SPRING	2	PZ																																								
Code	Description	Qty	UOM																																																										
OB1122A0	6 SERIES DOOR LOWER FRAME SHAPE	1	PZ																																																										
OB1122A1		1	PZ																																																										
RC1200A0	ED=4 WIRE D.=0.5 COMPRESSIO N SPRING	2	PZ																																																										



COMPONENT			SPARE PART																																																						
Code	Description	Image	Code	Description	Components list																																																				
0B1122A	6 SERIES DOOR LOWER FRAME SHAPE		K0B1122AL	CHEFTOP MM LEFT DOOR LOWER BEAM KIT	<table border="1"> <thead> <tr> <th>Code</th> <th>Description</th> <th>Qty</th> <th>UOM</th> </tr> </thead> <tbody> <tr> <td>VI1220A1</td> <td>4,2X12 TCB SELF-TAPPIN G SCREW</td> <td>1</td> <td>PZ</td> </tr> <tr> <td>VI1996A0</td> <td>M5X35 SCREW</td> <td>7</td> <td>PZ</td> </tr> <tr> <td>VM1794A0</td> <td>250X4.8 PA66 BLACK CLAMP</td> <td>2</td> <td>PZ</td> </tr> <tr> <td>VM2103A0</td> <td>CLAMP LOCK</td> <td>2</td> <td>PZ</td> </tr> <tr> <td>VM2267A0</td> <td>INTERNAL GLASS LOCKING SYSTEM SLIDER</td> <td>1</td> <td>PZ</td> </tr> <tr> <td>VM2269A0</td> <td>INTERNAL GLASS LOCKING SYSTEM CAP</td> <td>1</td> <td>PZ</td> </tr> <tr> <td>VM2274A0</td> <td>GROOVED BUSHING</td> <td>1</td> <td>PZ</td> </tr> <tr> <td>VM2305A0</td> <td>6 SERIES DOOR CAP FIXING PAWL</td> <td>7</td> <td>PZ</td> </tr> <tr> <td>VM2384A0</td> <td>LEFT MM DOOR LOWER RIGHT CAP</td> <td>1</td> <td>PZ</td> </tr> <tr> <td>VM2384A0</td> <td>LEFT MM DOOR LOWER RIGHT CAP</td> <td>1</td> <td>PZ</td> </tr> <tr> <td>VM2386A1</td> <td>LEFT MM DOOR LOWER LEFT CAP</td> <td>1</td> <td>PZ</td> </tr> <tr> <td>VM2386A1</td> <td>LEFT MM DOOR LOWER LEFT CAP</td> <td>1</td> <td>PZ</td> </tr> </tbody> </table>	Code	Description	Qty	UOM	VI1220A1	4,2X12 TCB SELF-TAPPIN G SCREW	1	PZ	VI1996A0	M5X35 SCREW	7	PZ	VM1794A0	250X4.8 PA66 BLACK CLAMP	2	PZ	VM2103A0	CLAMP LOCK	2	PZ	VM2267A0	INTERNAL GLASS LOCKING SYSTEM SLIDER	1	PZ	VM2269A0	INTERNAL GLASS LOCKING SYSTEM CAP	1	PZ	VM2274A0	GROOVED BUSHING	1	PZ	VM2305A0	6 SERIES DOOR CAP FIXING PAWL	7	PZ	VM2384A0	LEFT MM DOOR LOWER RIGHT CAP	1	PZ	VM2384A0	LEFT MM DOOR LOWER RIGHT CAP	1	PZ	VM2386A1	LEFT MM DOOR LOWER LEFT CAP	1	PZ	VM2386A1	LEFT MM DOOR LOWER LEFT CAP	1	PZ
Code	Description	Qty	UOM																																																						
VI1220A1	4,2X12 TCB SELF-TAPPIN G SCREW	1	PZ																																																						
VI1996A0	M5X35 SCREW	7	PZ																																																						
VM1794A0	250X4.8 PA66 BLACK CLAMP	2	PZ																																																						
VM2103A0	CLAMP LOCK	2	PZ																																																						
VM2267A0	INTERNAL GLASS LOCKING SYSTEM SLIDER	1	PZ																																																						
VM2269A0	INTERNAL GLASS LOCKING SYSTEM CAP	1	PZ																																																						
VM2274A0	GROOVED BUSHING	1	PZ																																																						
VM2305A0	6 SERIES DOOR CAP FIXING PAWL	7	PZ																																																						
VM2384A0	LEFT MM DOOR LOWER RIGHT CAP	1	PZ																																																						
VM2384A0	LEFT MM DOOR LOWER RIGHT CAP	1	PZ																																																						
VM2386A1	LEFT MM DOOR LOWER LEFT CAP	1	PZ																																																						
VM2386A1	LEFT MM DOOR LOWER LEFT CAP	1	PZ																																																						